

Open Carrier Frequency Doubler For Microwave Telecommunications

Rev. V1

Features

- Input Frequency 1.5 to 8.0 GHz
- Output Frequency 3.0 to 16.0 GHz
- Input Drive Level +10 dBm (nominal)
- Microstrip Interface

Description

The FDC2310 is a passive bridge diode frequency doubler, designed for use in military, commercial and test equipment applications. The design utilizes Schottky bridge quad diodes and broadband soft dielectric baluns to attain excellent performance. Environmental screening available to MIL-STD-883, MIL-STD-202, or MIL-DTL-28837, consult factory.

Product Image

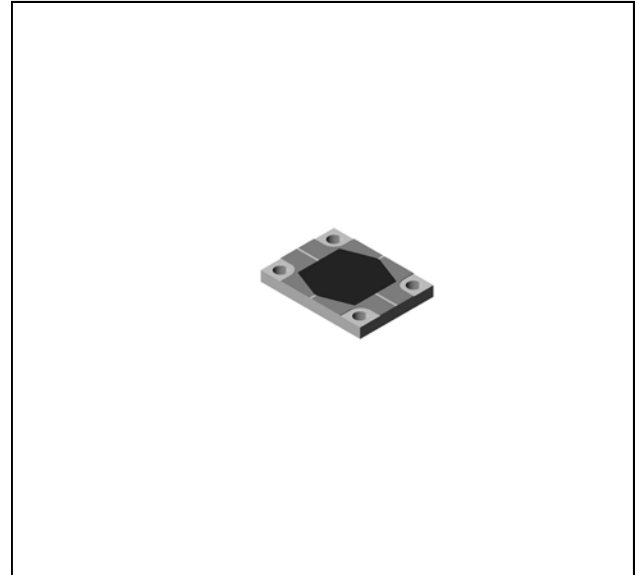

Ordering Information

Part Number	Package
FDC2310	Open Carrier

Electrical Specifications: $Z_0 = 50\Omega$ $P_{in} = +10$ dBm

Parameter	Test Conditions	Units	Typical	Guaranteed	
				+25°C	-40° to +85°C
SSB Conversion Loss (max)	$f_{in} = 1.5$ to 8.0 GHz	dB	11	14.0	14.5
Fundamental Suppression (min)	$f_{in} = 1.5$ to 8.0 GHz	dBc	35	19.5	19
Third Harmonic Suppression (min)	$f_{in} = 1.5$ to 8.0 GHz	dBc	40	20	18
Input VSWR	$f_{in} = 1.5$ to 8.0 GHz		2.0:1		

Open Carrier Frequency Doubler For Microwave Telecommunications

Rev. V1

Typical Performance Curves

Conversion Loss

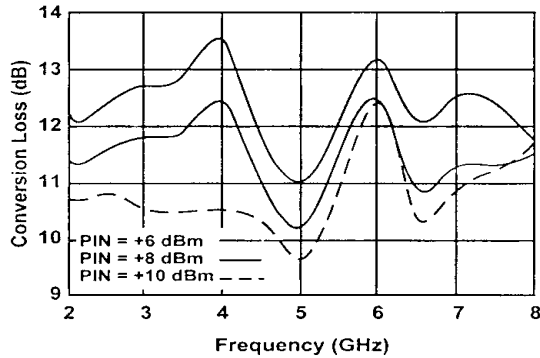

Conversion Loss

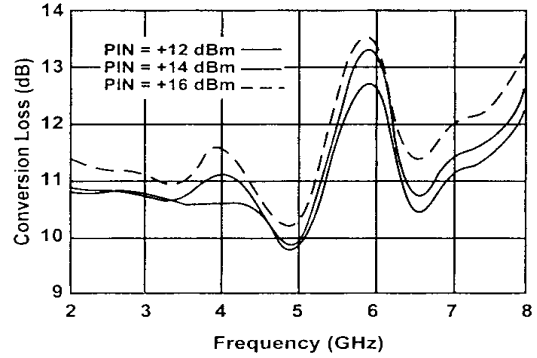

Input VSWR

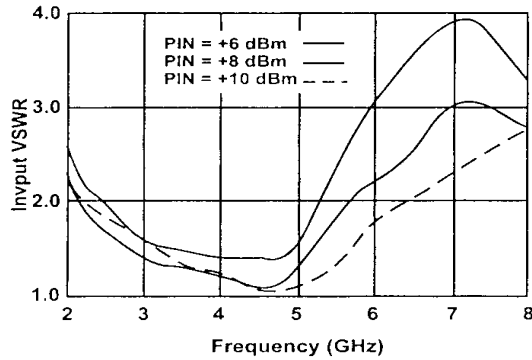

Input VSWR

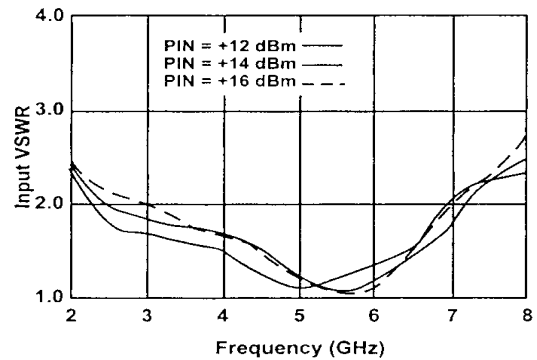

Fundamental Suppression

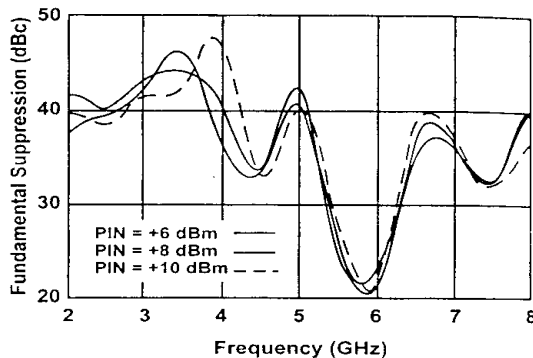

Fundamental Suppression

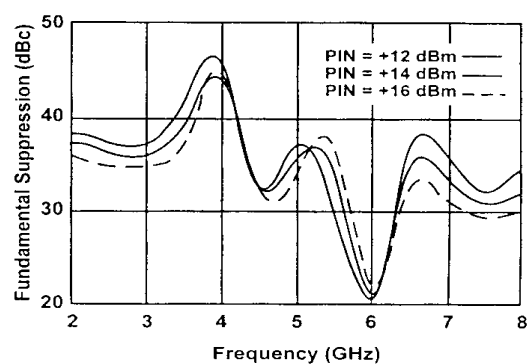

Open Carrier Frequency Doubler For Microwave Telecommunications

Rev. V1

Absolute Maximum Ratings

Parameter	Absolute Maximum
Operating Temperature	-54°C to +100°C
Storage Temperature	-65°C to +100°C
Peak Input Power	+23 dBm max @ +25°C +20 dBm max @ +100°C
Peak Input Current	50 mA DC

Outline Drawing: Open Carrier *

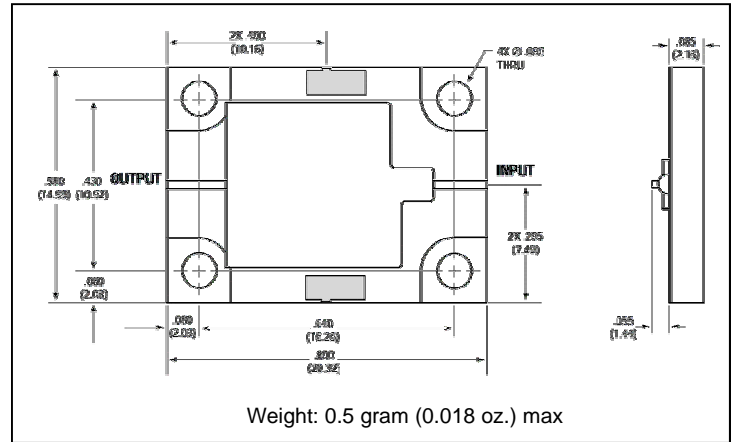

* Dimensions are inches (millimeters) ±0.015 (0.38) unless otherwise specified.

Third Harmonic Suppression

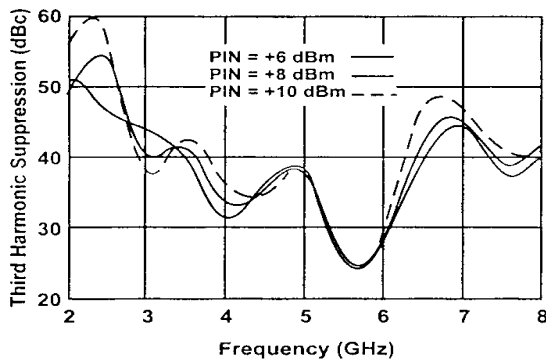

Third Harmonic Suppression

