

Open Carrier Frequency Doubler For Microwave Telecommunications

Rev. V2

Features

- INPUT: 3.5 TO 8.0 GHz
- OUTPUT: 7.0 TO 16.0 GHz
- INPUT DRIVE LEVEL +10 dBm (NOMINAL)
- MICROSTRIP INTERFACE

Description

The FDC2710 is a passive bridge diode frequency doubler, designed for use in the high volume commercial and test equipment applications. The design utilizes Schottky bridge quad diodes and broadband baluns to attain excellent performance. The use of high temperature solder and welded assembly processes used internally makes it ideal for use in semi-automated and automated assembly. Environmental screening available to MIL-STD-883, MIL-STD-202, or MIL-DTL-28837, consult factory.

Product Image

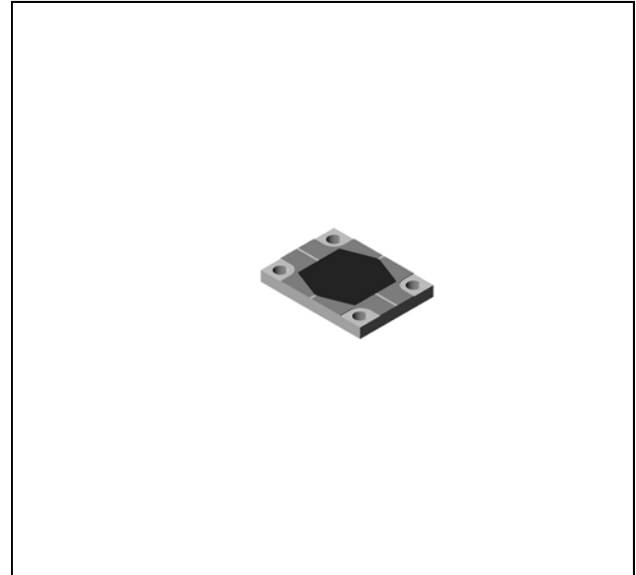

Ordering Information

Part Number	Package
FDC2710	Open Carrier

Electrical Specifications: $Z_0 = 50\Omega$ $P_{in} = +10$ dBm

Parameter	Test Conditions	Units	Typical	Guaranteed	
				+25°C	-40° to +85°C
SSB Conversion Loss (max)	$f_{in} = 3.5$ to 4.5 GHz	dB	13.0	14.0	14.5
	$f_{in} = 4.5$ to 7.0 GHz	dB	10.2	12.5	13.0
	$f_{in} = 7.0$ to 8.0 GHz	dB	11.2	13.5	14.0
Fundamental Suppression (min)	$f_{in} = 3.5$ to 6.5 GHz	dBc	40	28	26
	$f_{in} = 6.5$ to 8.0 GHz	dBc	40	30	28
Third Harmonic Suppression (min)	$f_{in} = 6.5$ to 8.0 GHz	dBc	50	40	38

Typical Performance Curves

Conversion Loss

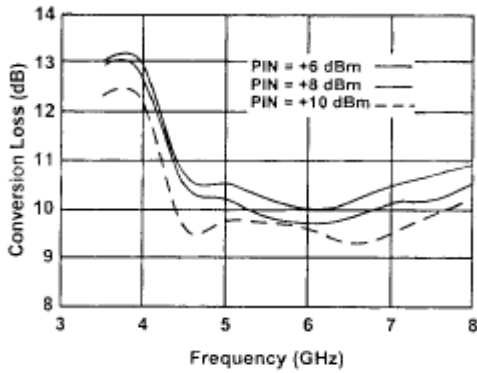

Third Harmonic Suppression

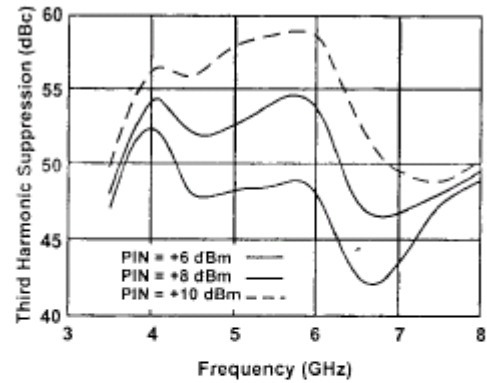

Conversion Loss

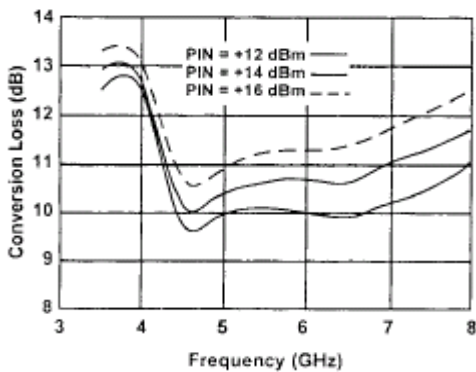

Third Harmonic Suppression

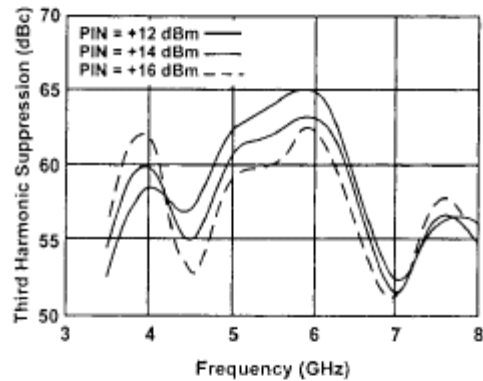

Input VSWR

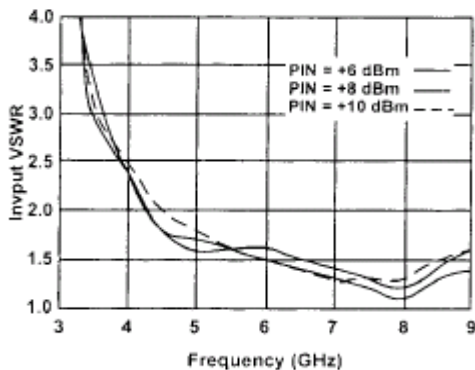

Input VSWR

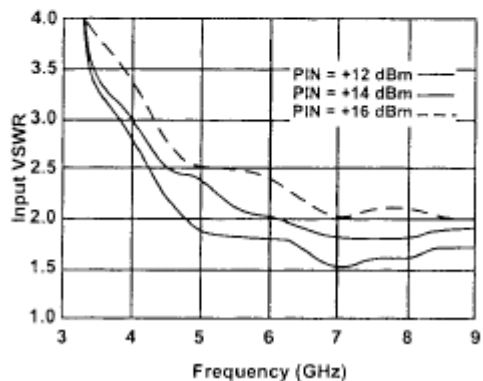

FDC2710

Open Carrier Frequency Doubler For Microwave Telecommunications

Rev. V2

Absolute Maximum Ratings

Parameter	Absolute Maximum
Operating Temperature	-54°C to +100°C
Storage Temperature	-65°C to +100°C
Peak Input Power	+23 dBm max @ +25°C +20 dBm max @ +100°C
Peak Input Current	50 mA DC

Outline Drawing: Open Carrier *

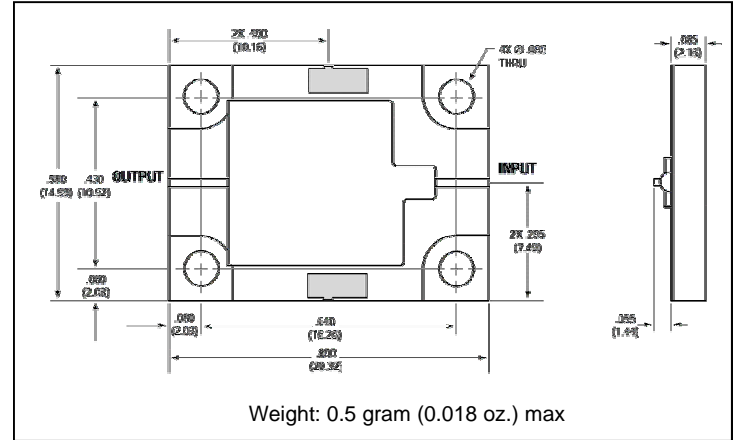

* Dimensions are inches (millimeters) ± 0.015 (0.38) unless otherwise specified.

Fundamental Suppression

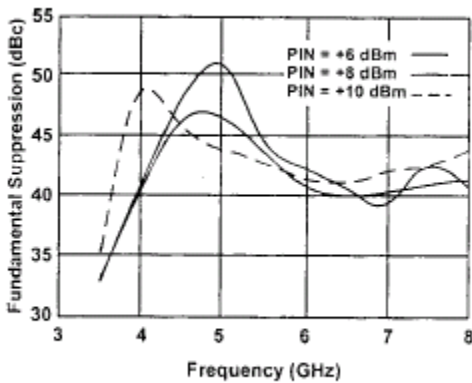

Fundamental Suppression

