

### Features

- Low Phase Noise
- Wide Tuning Range
- Divide-by-Two Output
- Integrated Buffer Amplifier
- Excellent Temperature Stability
- +5V Bias
- Lead-Free 5 mm 32-Lead PQFN Package
- Halogen-Free "Green" Mold Compound
- RoHS\* Compliant and 260°C Reflow Compatible

### Description

The MAOC-009268 is an InGaP HBT-based voltage controlled oscillator for frequency generation. No external matching components are required. This VCO is easily integrated into a phase lock loop using the divide-by-two output. The extremely low phase noise makes this part ideal for many radio applications including high capacity digital radios.

The MAOC-009268 primary applications are Point-to-Point Radio, Point-to-Multipoint Radio, Communications Systems, and Low Phase Noise applications.

The 5 mm PQFN package has a lead-free finish that is RoHS compliant and compatible with a 260°C reflow temperature. The package also features low lead inductance and an excellent thermal path.

### Ordering Information<sup>1</sup>

Part Number	Package
MAOC-009268-TR0500	500 piece reel
MAOC-009268-TR1000	1000 piece reel
MAOC-009268-SMB003	Sample Board

1. Reference Application Note M513 for reel size information.

### Block Diagram

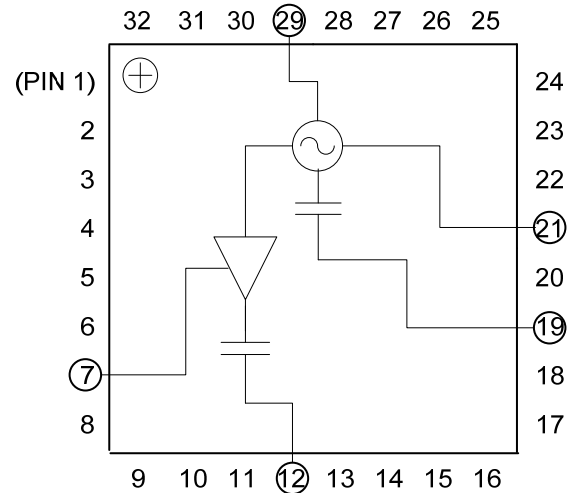

### Pin Designations<sup>2</sup>

Pin	Function	Pin	Function
1	N/C	17	N/C
2	N/C	18	N/C
3	N/C	19	RF
4	N/C	20	N/C
5	N/C	21	V <sub>CC</sub>
6	N/C	22	N/C
7	V <sub>BUFFER</sub>	23	N/C
8	N/C	24	N/C
9	N/C	25	N/C
10	N/C	26	N/C
11	N/C	27	N/C
12	RF/2	28	N/C
13	N/C	29	V <sub>TUNE</sub>
14	N/C	30	N/C
15	N/C	31	N/C
16	N/C	32	N/C

2. The exposed pad centered on the package bottom must be connected to RF and DC ground. Connecting all N/C pins to RF/DC Ground in the layout is also recommended.

\* Restrictions on Hazardous Substances, European Union Directive 2002/95/EC.

## Voltage Controlled Oscillator 12.7 - 14.2 GHz

Rev. V2

**Electrical Specifications:  $T_A = +25^\circ\text{C}$ ,  $V_{CC} = V_{BUFFER} = 5.0 \text{ V}^3$ ,  $Z_0 = 50 \Omega$**

Parameter	Test Conditions	Units	Min.	Typ.	Max.
Output Power	RF Port, 12.7 - 14.2 GHz RF/2 Port, 6.35 - 7.1 GHz	dBm	6 -3	9 1	—
SSB Phase Noise $V_{CC}=V_{BUFFER}=V_{TUNE}=5\text{V}$	RF Port, 10KHZ Offset RF Port, 100KHZ Offset	dBc/Hz	—	-79 -108	—
Harmonics/Subharmonics $V_{CC}=V_{BUFFER}=V_{TUNE}=5\text{V}$	RF Port, $\frac{1}{2} F_o$ RF Port, $2 F_o$	dBc	—	-16 -38	—
Pulling (Sensitivity to Match) $V_{CC}=V_{BUFFER}=V_{TUNE}=5\text{V}$	RF Port, VSWR = 1.95:1 to 2.25:1	MHz pk-pk	—	10	—
Pushing (Sensitivity to Supply Voltage)	RF Port, $V_{TUNE} = 5 \text{ V}$ RF/2 Port, $V_{TUNE} = 5 \text{ V}$	MHz/V	—	10 5	—
Frequency Drift Rate (Sensitivity to Temperature)	RF Port, 12.7 - 14.2 GHz RF/2 Port, 6.35 - 7.1 GHz	MHz/ $^\circ\text{C}$	—	1.2 0.7	—
Output Return Loss	RF Port, 12.7 - 14.2 GHz RF/2 Port, 6.35 - 7.1 GHz	dB	—	2.5 6	—
Tuning Sensitivity @ RF Port	$V_{TUNE} = 5 \text{ V}$	GHz/V	—	0.21	—
Supply Current	$I_{TOTAL} (I_{CC} + I_{BUFFER})$ $I_{CC}$ $I_{BUFFER}$	mA	—	165 145 20	205 175 30
Tune Voltage	$V_{TUNE}$	V	1	—	13
Tuning Current Leakage	$V_{TUNE} = 13 \text{ V}$	$\mu\text{A}$	—	5	10

3. VCO can operate over the 4.75 V to 5.25 V supply voltage range.

### Absolute Maximum Ratings <sup>4,5,6</sup>

Parameter	Absolute Maximum
Supply Voltage ( $V_{CC}$ & $V_{BUFFER}$ )	+5.5 Vdc
$V_{TUNE}$	0 to +15 Vdc
Storage Temperature	-55 $^\circ\text{C}$ to +150 $^\circ\text{C}$
Operating Temperature	-40 $^\circ\text{C}$ to +85 $^\circ\text{C}$
Case Temperature ( $T_C$ ) (measured @ exposed pad)	+100 $^\circ\text{C}$
Junction Temperature <sup>7</sup>	+135 $^\circ\text{C}$

- Exceeding any one or combination of these limits may cause permanent damage to this device.
- M/A-COM Technology Solutions does not recommend sustained operation near these survivability limits.
- Operating at nominal conditions with  $T_J \leq +135^\circ\text{C}$  will ensure MTBF >  $2.5 \times 10^6$  hours.
- Junction Temperature ( $T_J$ ) =  $T_C + \Theta_{jc} * (V * I)$   
Typical thermal resistance ( $\Theta_{jc}$ ) = 35 $^\circ\text{C/W}$ .
  - For  $T_C = 25^\circ\text{C}$ ,  $T_J = 54^\circ\text{C}$  @ 5 V, 165 mA
  - For  $T_C = 85^\circ\text{C}$ ,  $T_J = 115^\circ\text{C}$  @ 5 V, 170 mA

### Handling Procedures

Please observe the following precautions to avoid damage:

### Static Sensitivity

Gallium Arsenide Integrated Circuits are sensitive to electrostatic discharge (ESD) and can be damaged by static electricity. Proper ESD control techniques should be used when handling these devices.



**ESD Rating: Class 1A**

- **North America** Tel: 800.366.2266 • **Europe** Tel: +353.21.244.6400
- **India** Tel: +91.80.43537383 • **China** Tel: +86.21.2407.1588

Visit [www.macomtech.com](http://www.macomtech.com) for additional data sheets and product information.

**ADVANCED:** Data Sheets contain information regarding a product M/A-COM Technology Solutions is considering for development. Performance is based on target specifications, simulated results, and/or prototype measurements. Commitment to develop is not guaranteed.

**PRELIMINARY:** Data Sheets contain information regarding a product M/A-COM Technology Solutions has under development. Performance is based on engineering tests. Specifications are typical. Mechanical outline has been fixed. Engineering samples and/or test data may be available. Commitment to produce in volume is not guaranteed.

M/A-COM Technology Solutions Inc. and its affiliates reserve the right to make changes to the product(s) or information contained herein without notice.

## Voltage Controlled Oscillator 12.7 - 14.2 GHz

Rev. V2

Typical Performance Curves:  $V_{CC} = V_{BUFFER} = 5V$ ,  $T_A = +25^\circ C$  (unless otherwise indicated)

Output Frequency vs. Tuning Voltage - RF Port

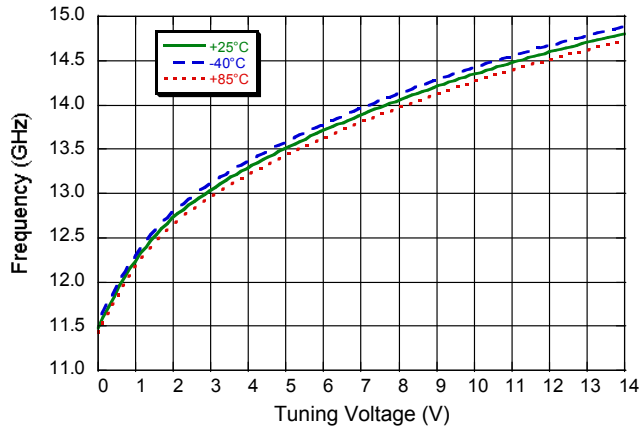

Output Frequency vs. Tuning Voltage - RF/2 Port

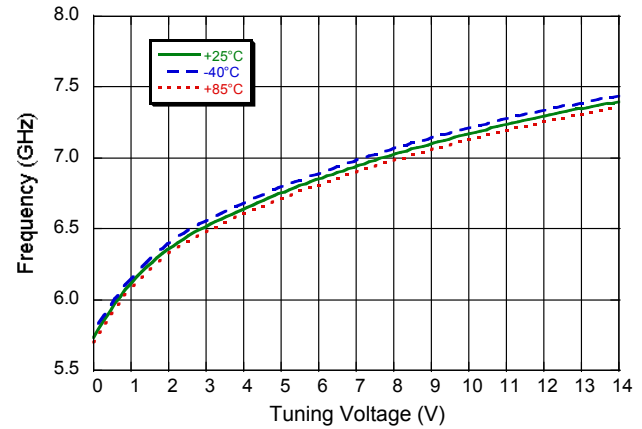

Output Frequency vs. Tuning / Supply Voltage - RF Port

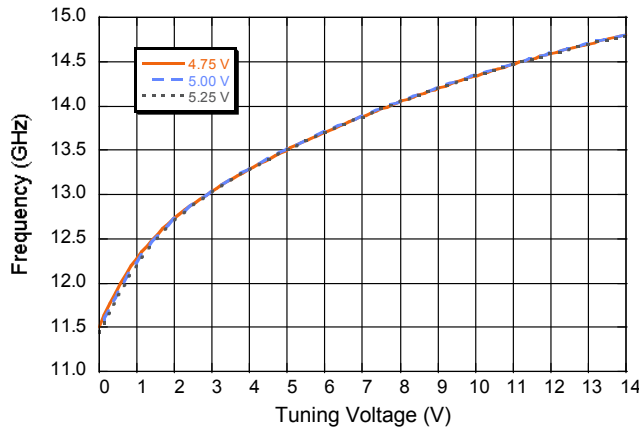

Output Frequency vs. Tuning / Supply Voltage - RF/2 Port

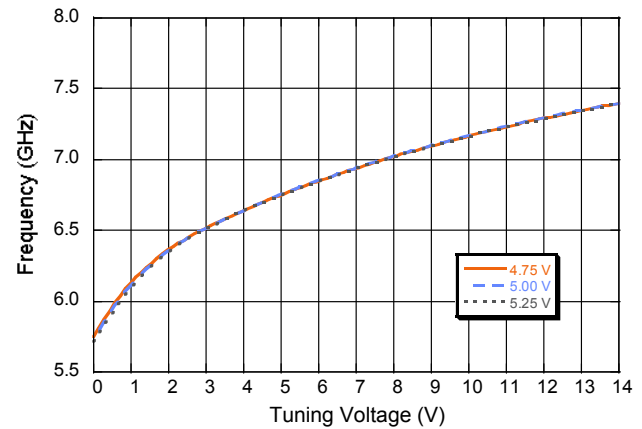

Output Power vs. Tuning Voltage - RF Port

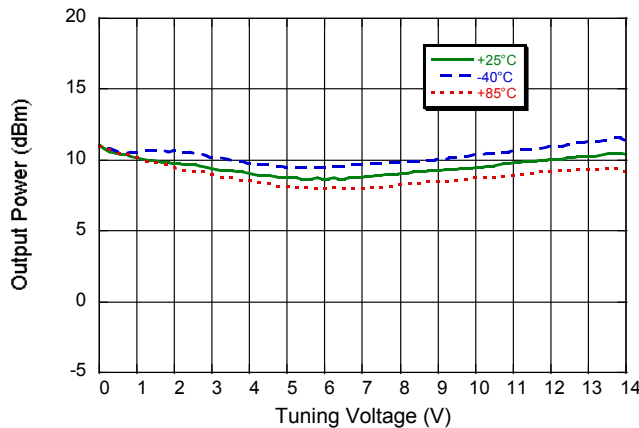

Output Power vs. Tuning Voltage - RF/2 Port

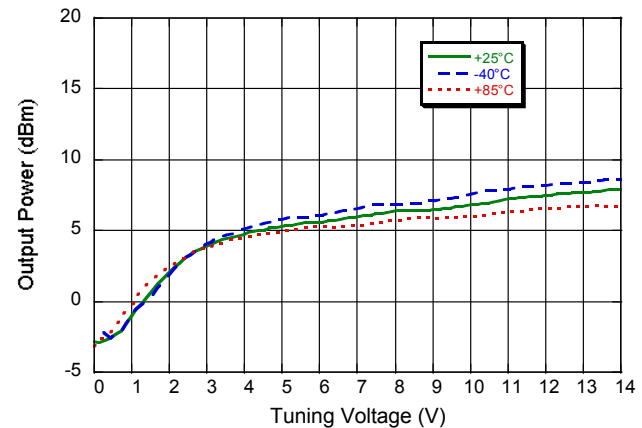

**ADVANCED:** Data Sheets contain information regarding a product M/A-COM Technology Solutions is considering for development. Performance is based on target specifications, simulated results, and/or prototype measurements. Commitment to develop is not guaranteed.

**PRELIMINARY:** Data Sheets contain information regarding a product M/A-COM Technology Solutions has under development. Performance is based on engineering tests. Specifications are typical. Mechanical outline has been fixed. Engineering samples and/or test data may be available. Commitment to produce in volume is not guaranteed.

• **North America** Tel: 800.366.2266 • **Europe** Tel: +353.21.244.6400  
 • **India** Tel: +91.80.43537383 • **China** Tel: +86.21.2407.1588  
 Visit [www.macomtech.com](http://www.macomtech.com) for additional data sheets and product information.

M/A-COM Technology Solutions Inc. and its affiliates reserve the right to make changes to the product(s) or information contained herein without notice.

## Voltage Controlled Oscillator 12.7 - 14.2 GHz

Rev. V2

Typical Performance Curves:  $V_{CC} = V_{BUFFER} = 5V$ ,  $T_A = +25^\circ C$  (unless otherwise indicated)

Frequency Sensitivity vs. Tuning Voltage - RF Port

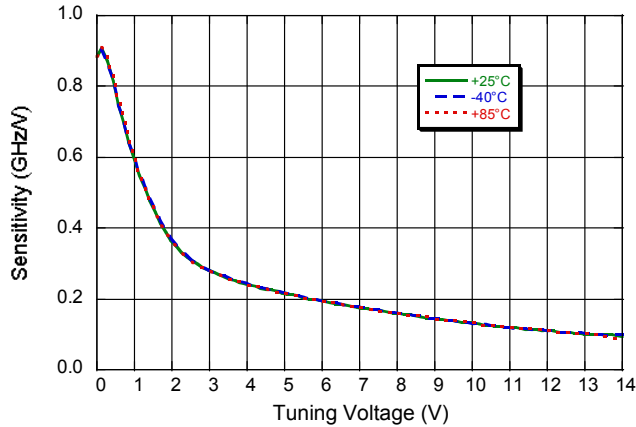

Frequency Sensitivity vs. Tuning Voltage - RF/2 Port

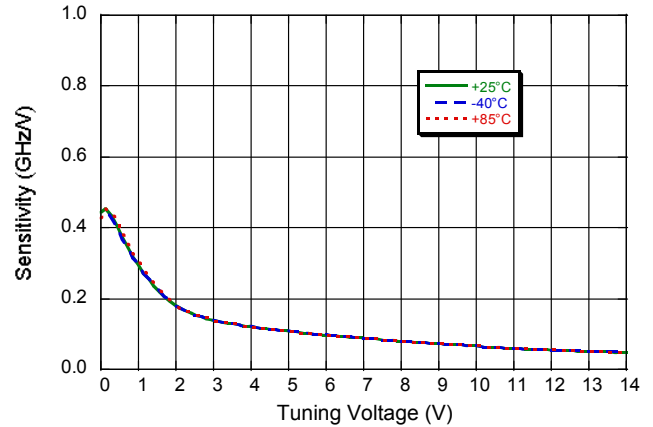

Single Side Band Phase Noise vs. Tuning Voltage  
RF Port

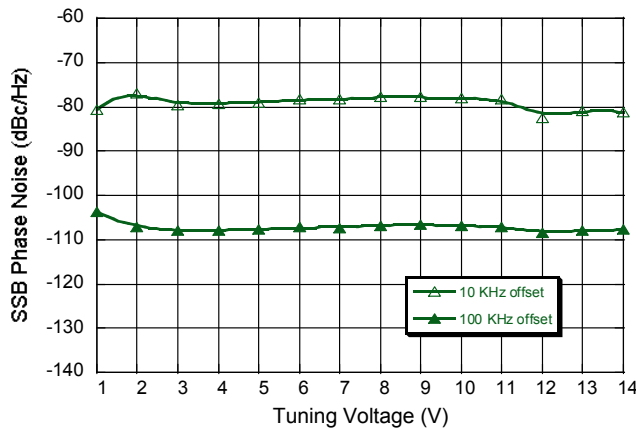

Single Side Band Phase Noise vs. Frequency Offset  
RF Port ( $V_{TUNE} = 5V$ )

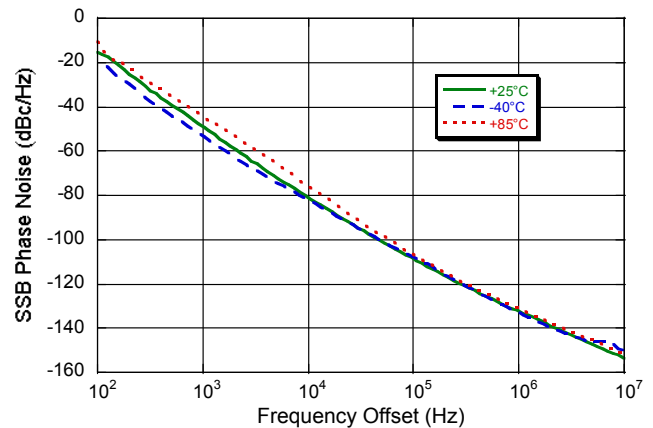

## Voltage Controlled Oscillator 12.7 - 14.2 GHz

Rev. V2

### Sample Board

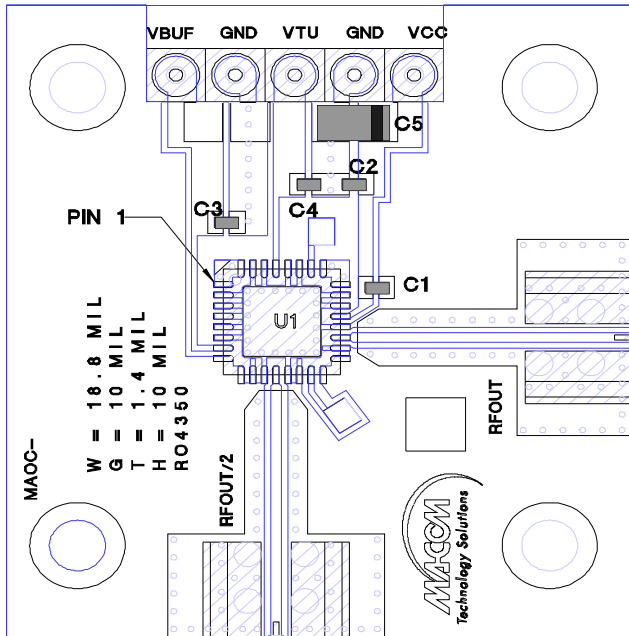

### Parts List

Component	Value	Case Size
C1	100 pF	0402
C2, C3, C4	0.1 $\mu$ F	0402
C5	10 $\mu$ F Tantalum	1206

### Lead-Free 5 mm 32-Lead PQFN<sup>†</sup>

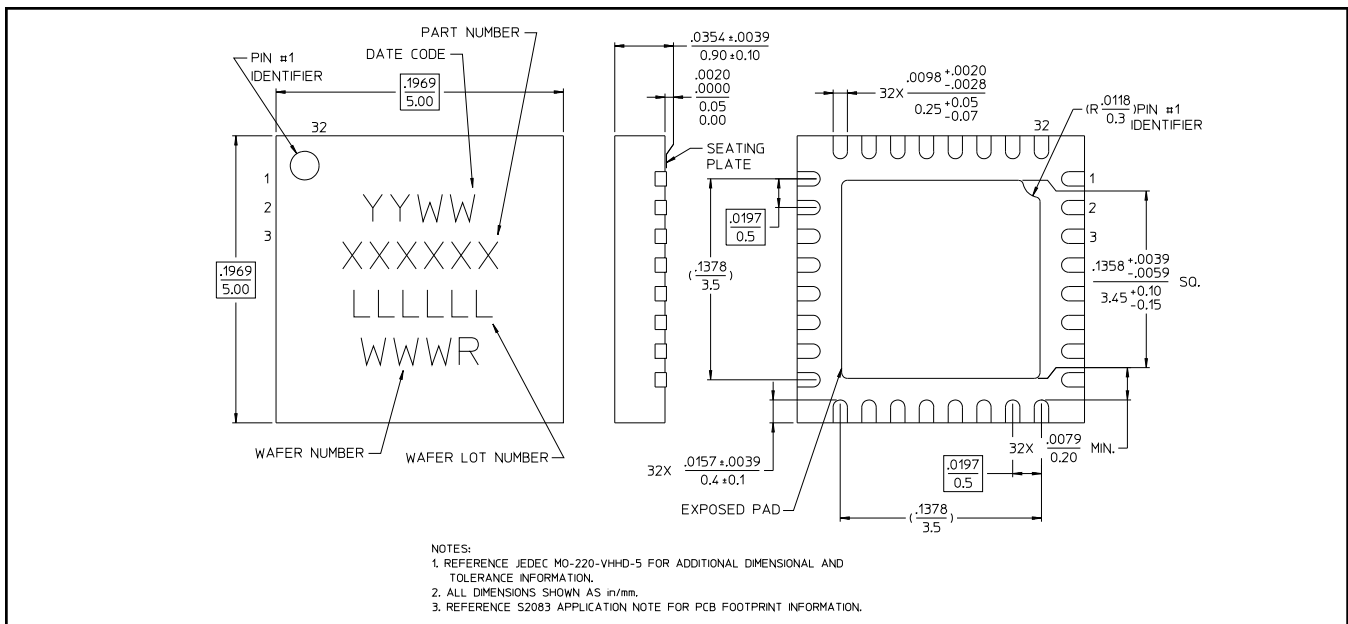

<sup>†</sup> Reference Application Note S2083 for lead-free solder reflow recommendations.  
 Meets JEDEC moisture sensitivity level 1 requirements.  
 Plating is 100% matte tin over copper.