

Double-Balanced Mixer

Rev. V2

Features

- LO and RF: 1.8 to 6.2 GHz
- IF: DC to 2 GHz
- LO Drive +7 dBm (nominal)
- High Isolation 35 dB (Typ.)

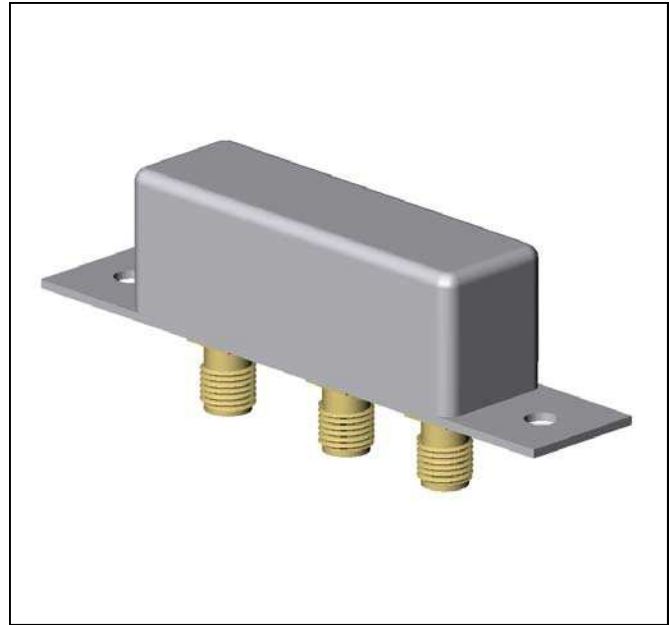

Guaranteed Specifications¹

Characteristics	Min	Typ.	Max.	Test Conditions
SSB Conversion Loss And SSB Noise Figure		7.0 dB	8.5 dB	fL & fR 1.8 to 4.2 GHz fI 0.01 to 1 GHz
		8.5 dB	9.5 dB	fL & fR 1.8 to 4.2 GHz fI 0.01 to 2 GHz
		9.0 dB	10.0 dB	fL & fR 1.8 to 6.2 GHz fI 0.01 to 2 GHz
Isolation fL at R fL at I fL at R fL at I	25 dB	40 dB		fL 1.8 to 4.2 GHz
	15 dB	25 dB		
	18 dB	25 dB		fL 4.2 to 6.2 GHz
	15 dB	20 dB		
Conversion Compression		1.0 dB		fR = 0 dBm fL at +7 dB,

Notes:

1. Measure in a 50-Ohm system with nominal LO drive and downconverter application only, unless otherwise specified. The I-Port frequency range extends to DC for phase detection, pulse modulation, or attenuator applications, I-Port VSWR degrades from a 50-Ohm system at low IF frequencies.

Absolute Maximum Ratings

Storage Temperature	-65°C to +100°C
Operating Temperature	-54°C to +100°C
Peak RF Input Power	+17 dBm
Peak Input Current at 25°C	50 mA DC

Weight 31 gram (1.1 oz) max.

Double-Balanced Mixer

Rev. V2

Typical Performance Curves at 25°C

Conversion Loss

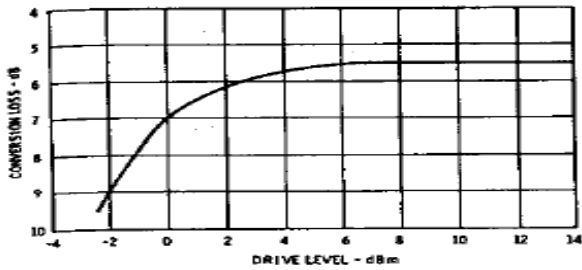

Conversion Loss vs. Drive Level: Conversion loss in an SSB system is a function of drive level (f_L with f_R at approximately 3 GHz and f_R level at -6 dBm).

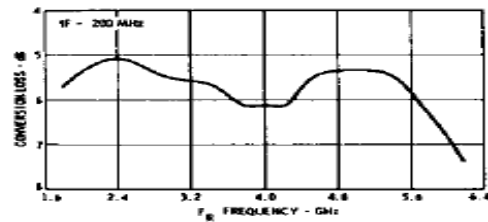
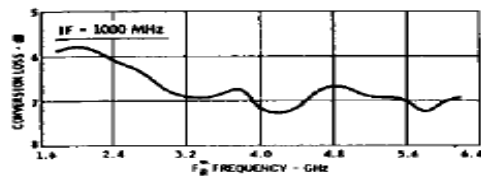

Conversion Loss vs. Input Frequency: The frequency ordinate refers to the report (f_R) with f_L at 200 MHz and 1000 MHz, data plotted with f_L at $+7$ dBm.

Isolation

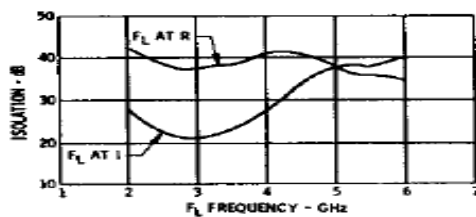

Isolation vs. Frequency: Level of the f_L signal fed through to the R- and I-ports with respect to the level of the f_L signal at the L-port.

VSWR

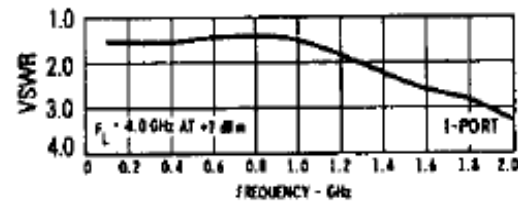
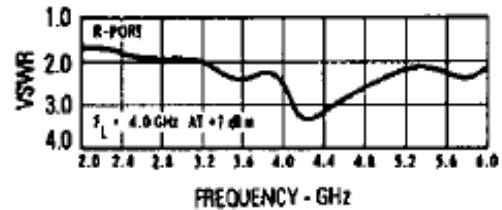
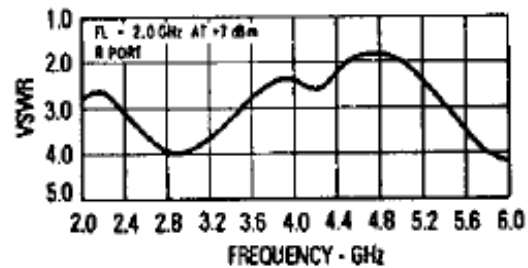
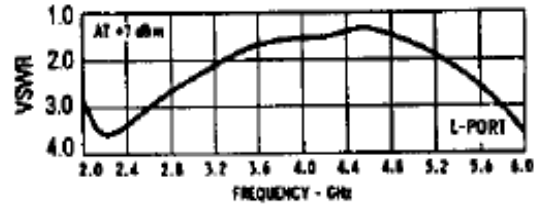

VSWR vs. Frequency: VSWR of the L-, I- and R-ports in a 50-ohm system. Some variation in the R-port VSWR will occur as a function of the L-port frequency as shown above. Curves for R-port VSWR are plotted for L-port frequencies of 2 GHz and 4 GHz. A plot of I-port VSWR is also shown with f_L at 4 GHz.

Outline Drawing: M1H

