

CF004 Series GaAs Pseudomorphic HEMT and MESFET Chips

- ❑ Super Low Noise: 1.5 dB at 18 GHz
- ❑ High Gain: Usable to 44 GHz
- ❑ Flat Gain for Distributed Amplifiers
- ❑ Active Layers Include:
Pseudomorphic HEMT, Epitaxial
and Ion Implanted
- ❑ Wafer Qualification Procedure
- ❑ Customer Wafer Selection Available

Celeritek CF004 Series Chips

Celeritek CF004 Series chips are GaAs based transistors which include the CF004-01, CF004-02 and CF004-03 models. They are 150 μm gate width, sub-half-micron gate length GaAs devices with Celeritek's proprietary Silicon Nitride passivation.

Celeritek's Wafer Qualification Procedure for CF004 Series FETs consists of DC, RF and reliability testing of both individual die and generic 6 to 18 GHz amplifier modules.

The CF004-01 provides unusually high gain in narrow- and wide-band applications up to 40 GHz. For example, 9 dB of gain is achievable in a 6 to 18 GHz balanced amplifier circuit; 5 dB of gain can be realized in an 18 to 40 GHz circuit.

The CF004-03 model is Celeritek's state-of-the-art GaAs Pseudomorphic HEMT device. It provides the lowest noise and highest gain attainable above 18 GHz. Its rugged construction allows it to withstand the same input power as conventional MESFETs.

All CF004 Series devices exhibit extraordinarily flat S_{21} vs frequency making them excellent for distributed amplifier circuits. These devices are available in chip form and are suitable for airborne, shipboard and ground-based equipment. Screening includes MIL-STD-750 Class B, Class S and commercial screening.

CELERITEK

[161]

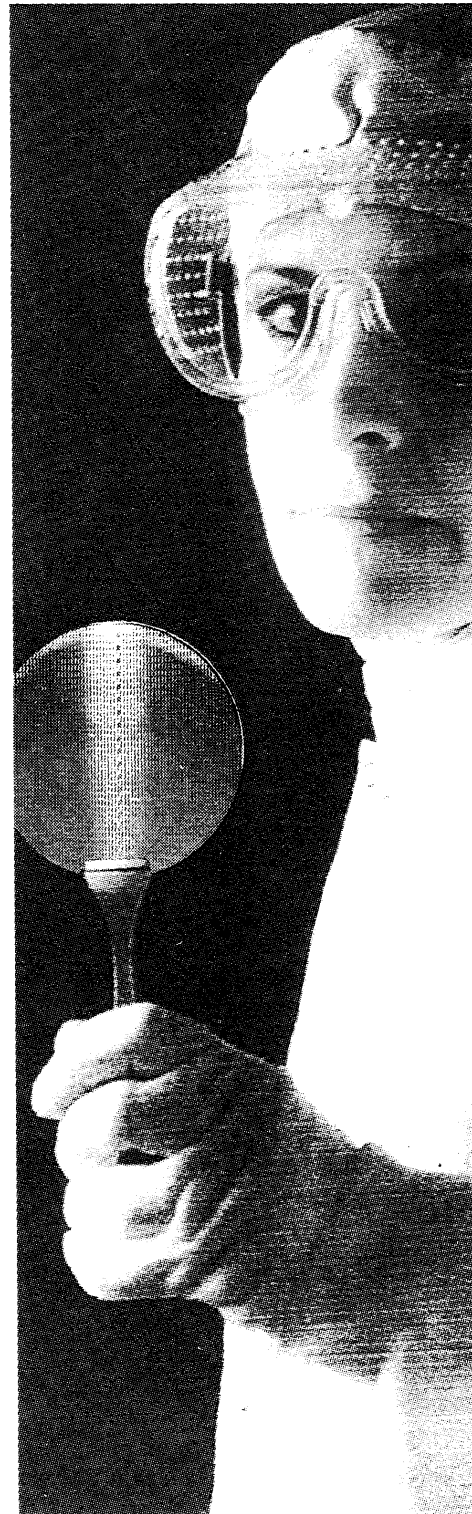

GaAs Pseudomorphic HEMT and MESFET Chips

CF004 Series GaAs Chips

Specifications (T _A = 25°C)				CF004-01			CF004-02			CF004-03		
Active Layer				Ion Implanted			Epitaxial			Pseudomorphic HEMT		
Symbol	Parameters and Conditions	Frequency (GHz)	Units	Min	Typ	Max	Min	Typ	Max	Min	Typ	Max
NF _{opt}	Optimum Noise Figure V _{DS} = 3.0 V, I _{DS} = 10 mA	18.0	dB		2.2	3.0		1.8	2.4		1.5	2.0
Ga	Gain at NF _{opt} V _{DS} = 3.0 V, I _{DS} = 10 mA	18.0	dB	7.0	8.0		8.0	9.0		9.0	10.0	
S ₂₁ ²	50 Ohm Insertion Gain V _{DS} = 6.0 V, I _{DS} = 25 mA	2.0	dB		8.0			9.0			10.0	
		10.0	dB		8.0			9.0			10.0	
		18.0	dB		7.0			8.0			9.0	
		26.0	dB		3.0			4.0			5.0	
P _{1dB}	Power Output @ 1 dB GC V _{DS} = 6.0 V, I _{DS} = 25 mA	12.0	dBm		15.0			13.0			13.0	
g _m	Transconductance V _{DS} = 3.0 V, V _{GS} = 0 V		mS		30			40			45	
I _{DSS}	Drain Current V _{DS} = 3.0 V, V _{GS} = 0 V		mA	20	30	60	15	30	60	15	30	60
V _p	Pinchoff Voltage V _{DS} = 3.0 V, I _{DS} = 1 mA		Volts	-0.7	-1.3	-2.5	-0.5	-1.3	-2.5	-0.5	-1.3	-2.5
BV _{GD}	Breakdown Voltage, Gate-Drain I _{GD} = 100 μA		Volts	-5.5	-8.0		-5.5	-8.0		-5.5	-8.0	
R _{th}	Thermal Resistance		°C/W		300			300			300	

Absolute Maximum Ratings

Parameter	Symbol	Rated	Limit
Drain-Source Voltage	V _{DS}	8V	
Gate-Source Voltage	V _{GS}	-5V	
Drain Current	I _{DS}	I _{DSS}	
Continuous Dissipation	P _T	400 mW	
Channel Temperature	T _{CH}	175°C	
Storage Temperature	T _{STG}	-65°C to +175°C	

Typical Noise Parameters - CF004-03

Frequency (GHz)	NF _{opt} (dB)	Ga (dB)	Gamma _{opt} (Mag)	Gamma _{opt} (Ang)	Rn/50
2.0	0.44	18.9	0.94	4	1.60
4.0	0.55	16.7	0.86	9	1.10
6.0	0.67	14.9	0.78	17	0.81
8.0	0.80	13.6	0.72	28	0.64
10.0	0.93	12.5	0.66	41	0.54
12.0	1.08	11.8	0.60	52	0.46
14.0	1.23	11.1	0.53	62	0.39
16.0	1.40	10.6	0.43	72	0.32
18.0	1.57	10.1	0.32	86	0.25
20.0	1.75	9.6	0.22	110	0.20
22.0	1.94	9.0	0.16	146	0.17
24.0	2.14	8.3	0.19	-171	0.17
26.0	2.35	7.4	0.26	-152	0.19

Chip Outline Drawing

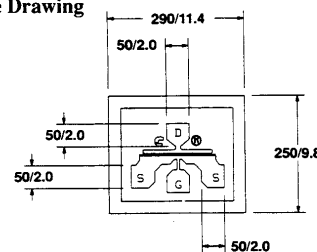

CF004 CHIP (UNITS IN MICRONS/MILS)
THICKNESS: 110 MICRONS/4.3 MILS

Die Attach and Bonding Procedures

Die Attach: Conductive epoxy or eutectic die attach is recommended. For eutectic die attach: Preform: AuSn (80% Au, 20% Sn); Stage Temperature: 290°C, ±5°C; Handling Tool: Tweezers; Time: 1 min or less.

Wire Bonding: Wire Size: 0.7 to 1.0 mil in diameter (pre-stressed); Thermocompression bonding is preferred over thermosonic bonding. For thermocompression bonding: Stage Temperature: 250°C; Bond Tip Temperature: 150°C; Bonding Tip Pressure: 18 to 40 gms depending on size of wire.

CELERITEK

[162]

CF004 Series GaAs Chips

Typical Performance ($T_A = 25^\circ\text{C}$)

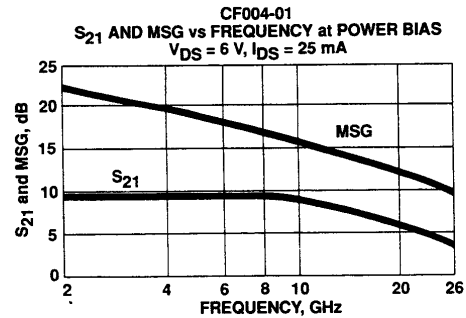
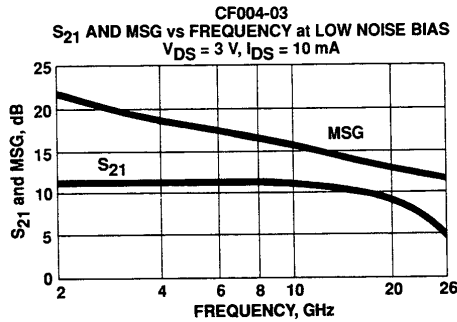
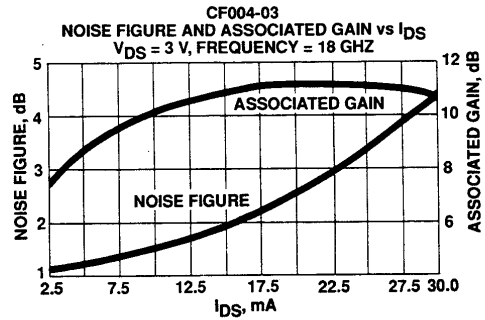
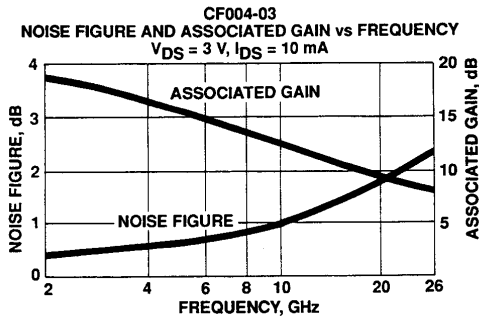

CF004-03
 S_{11} AND S_{22} vs FREQUENCY at LOW NOISE BIAS
 $V_{DS} = 3\text{ V}, I_{DS} = 10\text{ mA}$

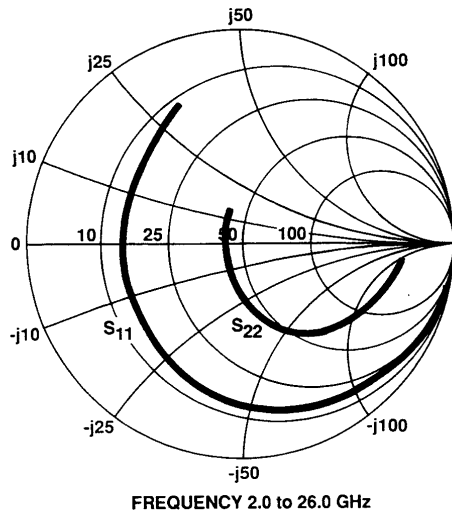

CF004-01
 S_{11} AND S_{22} vs FREQUENCY at POWER BIAS
 $V_{DS} = 6\text{ V}, I_{DS} = 25\text{ mA}$

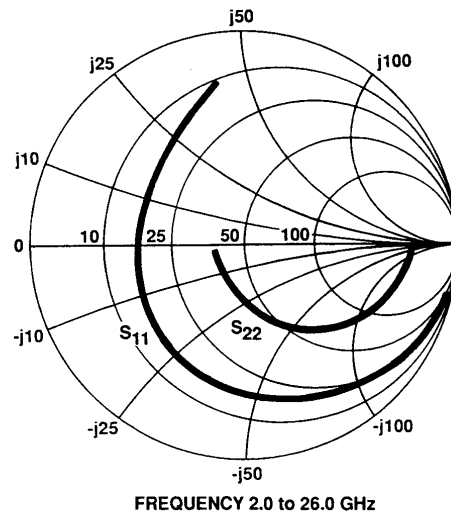

[163]

GaAs Pseudomorphic HEMT and MESFET Chips

CF004 Series GaAs Chips

Typical Scattering Parameters, Common Source (S-Parameters Include Bonding Wire Parasitics)

CF004-01 at Power Bias

$V_{DS} = 6\text{ V}$, $I_{DS} = 25\text{ mA}$

Frequency (GHz)	S ₁₁		S ₂₁		S ₁₂		S ₂₂		K	MSG (dB)		
	(Mag)	(Ang)	(dB)	(Mag)	(Ang)	(dB)	(Mag)	(Ang)				
2.0	0.97	-14	9.5	2.99	156	-35.3	0.02	78	0.77	-2	0.39	22.4
4.0	0.93	-30	9.7	3.04	150	-29.4	0.03	76	0.76	-7	0.43	19.5
6.0	0.86	-49	9.5	3.00	133	-26.2	0.05	67	0.75	-13	0.57	17.9
8.0	0.77	-73	9.4	2.97	114	-24.2	0.06	58	0.70	-21	0.70	16.8
10.0	0.67	-97	8.9	2.78	95	-23.4	0.07	43	0.65	-30	0.99	16.1
12.0	0.61	-120	8.4	2.62	78	-22.1	0.08	39	0.62	-40	1.00	15.2
14.0	0.55	-142	7.9	2.48	62	-21.3	0.09	34	0.60	-48	1.07	14.6
16.0	0.49	-168	7.5	2.36	47	-20.5	0.09	27	0.57	-54	1.15	14.0
18.0	0.49	157	7.0	2.24	30	-19.3	0.11	19	0.50	-61	1.12	13.1
20.0	0.55	125	6.2	2.05	12	-18.1	0.13	8	0.42	-68	1.06	12.2
22.0	0.66	109	5.1	1.79	-4	-18.1	0.13	1	0.29	-80	1.10	11.6
24.0	0.72	101	3.9	1.56	-17	-17.3	0.14	1	0.18	-105	1.08	10.6
26.0	0.78	98	2.8	1.38	-29	-16.4	0.15	-6	0.14	-164	0.95	9.6

CF004-03 at Low Noise Bias

$V_{DS} = 3\text{ V}$, $I_{DS} = 10\text{ mA}$

Frequency (GHz)	S ₁₁		S ₂₁		S ₁₂		S ₂₂		K	MSG (dB)		
	(Mag)	(Ang)	(dB)	(Mag)	(Ang)	(dB)	(Mag)	(Ang)				
2.0	0.98	-13	11.2	3.62	165	-32.8	0.02	82	0.76	-5	0.23	22.0
4.0	0.94	-26	11.1	3.60	153	-27.0	0.05	74	0.74	-11	0.31	19.1
6.0	0.90	-42	11.0	3.54	138	-23.8	0.06	65	0.71	-19	0.39	17.4
8.0	0.85	-61	11.0	3.53	122	-21.6	0.08	52	0.65	-30	0.47	16.3
10.0	0.77	-80	10.5	3.36	106	-20.5	0.09	37	0.59	-42	0.63	15.5
12.0	0.72	-97	10.2	3.25	91	-19.1	0.11	29	0.56	-54	0.63	14.7
14.0	0.66	-113	10.0	3.18	77	-18.3	0.12	20	0.53	-63	0.70	14.2
16.0	0.59	-136	10.0	3.15	63	-17.4	0.14	8	0.47	-71	0.77	13.7
18.0	0.55	-171	9.8	3.10	45	-16.2	0.16	-4	0.35	-82	0.80	13.0
20.0	0.57	149	9.2	2.89	24	-15.6	0.17	-17	0.20	-89	0.85	12.4
22.0	0.65	123	7.6	2.40	7	-15.9	0.16	-29	0.04	-131	0.93	11.7
24.0	0.68	112	5.9	1.97	-5	-16.5	0.15	-32	0.09	110	1.06	11.2
26.0	0.72	111	4.9	1.76	-13	-16.4	0.15	-35	0.18	111	1.02	10.7

Device Model

Parameters	CF004-01 $V_{DS} = 6\text{ V}$, $I_{DS} = 25\text{ mA}$	CF004-03 $V_{DS} = 3\text{ V}$, $I_{DS} = 10\text{ mA}$	Units
L_g	0.41	0.36	nH
R_g	2.0	2.0	Ω
C_{gs}	0.21	0.14	pF
R_i	6.6	2.5	Ω
C_{gd}	0.013	0.019	pF
G_m	38	45	mS
τ	2.2	2.1	ps
C_{ds}	0.060	0.060	pF
R_{ds}	357	359	Ω
R_d	2.7	2.7	Ω
L_d	0.37	0.33	nH
R_s	3.0	2.7	Ω
L_s	0.08	0.08	nH

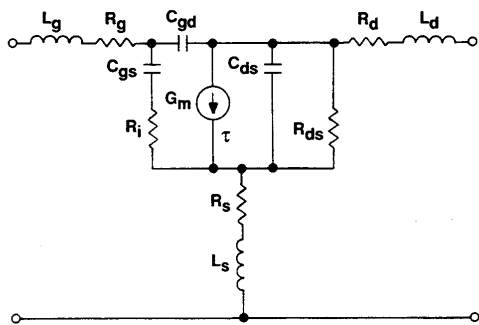

Wafer Qualification Procedure

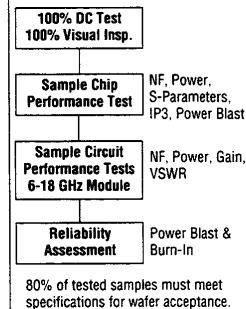

3236 Scott Boulevard
Santa Clara, California 95054
(408) 986-5060
Fax: (408) 986-5095

4-91

Specifications subject to change.

CELERITEK

[164]