

# 0.05-3.0 GHz High Dynamic Range Amplifier

April 2009 - Rev 16-Apr-09

## Features

- ✕ 0.05 to 3.0 GHz Frequency Range
- ✕ 41 dBm Output IP3
- ✕ 2.1 dB Noise Figure
- ✕ 14.5 dB Gain
- ✕ 23.5 dBm P1dB
- ✕ SOT-89 SMT Package
- ✕ Single Power Supply
- ✕ +3V to +5V Voltage Rail

## Functional Block Diagram

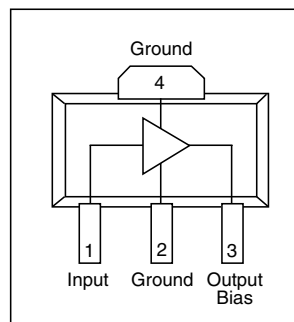

## Circuit Description

The CMM6004-SC is a high dynamic range amplifier designed for applications operating within the 0.05 to 3.0 GHz frequency range. It is an ideal solution for transmit and receive functions where high linearity is required. The amplifier has the flexibility of being optimized for a number of wireless applications. The combination of low NF and high IP3 at the same bias point make it an ideal transmit or receive solution when used in applications including cellular and PCS (personal communications service) operating from 0.8 to 2.2 GHz; MMDS (multichannel multipoint distribution systems) operating from 2.2 to 2.7 GHz; and WLAN (wireless LAN) operating at 2.4 GHz. The CMM6004-SC is packaged in a low-cost, space efficient, surface mount SOT-89 package which provides excellent electrical stability and low thermal resistance. All devices are 100% RF and DC tested.

## Absolute Maximum Ratings

Supply Voltage	+6.0 V
RF Input Power*	+20 dBm
Storage Temperature (Tstg)	-55 °C to +125 °C
Junction Temperature	150 °C
Operating Temperature	-40 °C to +85 °C
Thermal Resistance	52 °C/W
Moisture Sensitivity Level (MSL)	MSL1
ESD (MM)	A
ESD (HBM)	1A

Operation of this device above any of these parameters may cause damage.  
\*Operation with more than 10 dBm of input power may cause 2 dB degradation in OIP3 performance.

## Electrical Characteristics (T=25°C)

Unless otherwise specified, the following specifications are guaranteed at room temperature in a Mimix fixture.

Parameter	Condition	Min	Typ	Max	Units
Frequency Range		0.05		3.0	GHz
Gain	Externally matched	13.5	14.5		dB
Input Return Loss	Externally matched		-10		dB
Output IP3		+38	+41		dBm
Noise Figure			2.1		dB
Output P1dB			23		dBm
Operating Current Range		120	150	180	mA
Supply Voltage			5.0		V

Notes:

1. T = 25°C, Vdd = 5.0, Frequency = 800 MHz, 50 Ohm system

2. OIP3 measured with two tones at output power of 5 dBm/tone separated by 10 MHz.

## Typical Parameters

Parameter	Typical			Units
Frequency Range	900	1900	2400	MHz
Gain	16.5	14.5	13.6	dB
Input Return Loss	-18	-15	-15	dB
Output Return Loss	-14	-10	-12	dB
Output IP3	+41.5	+41.0	+41.0	dBm
Output P1dB	23.8	23.5	23.0	dBm
Noise Figure	1.8	2.2	2.3	dB

1. Typical values reflect performance in recommended application circuit.

# 0.05-3.0 GHz High Dynamic Range Amplifier

April 2009 - Rev 16-Apr-09

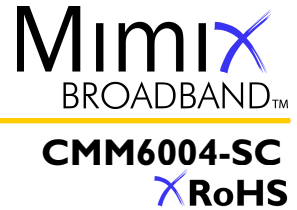

## Typical Performance

Output IP3 vs Frequency \*

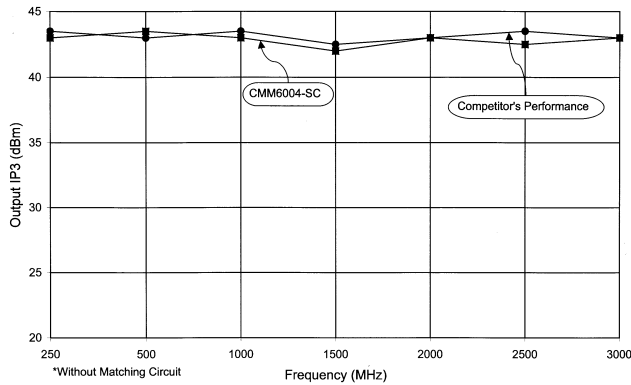

Gain vs Frequency \*

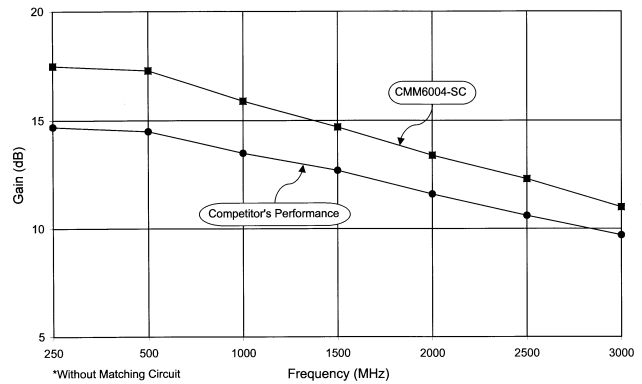

Input/Output Return Loss \*

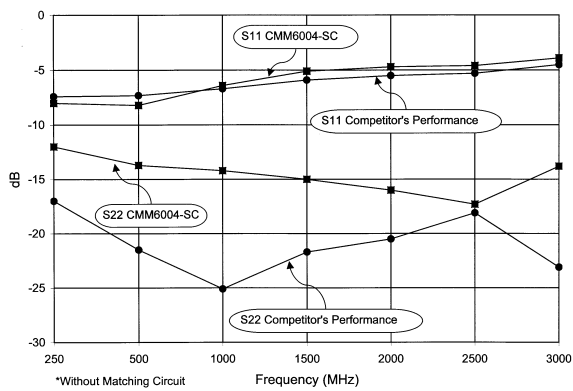

Noise Figure vs Frequency

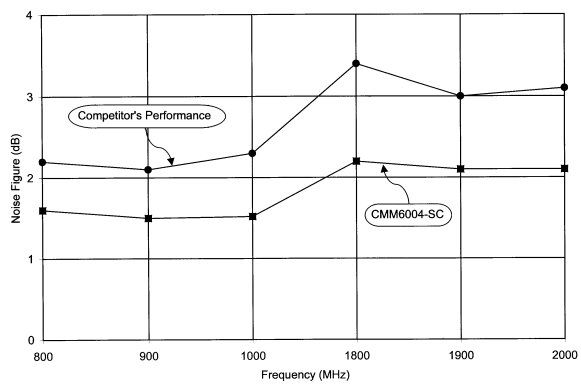

P1dB vs Frequency

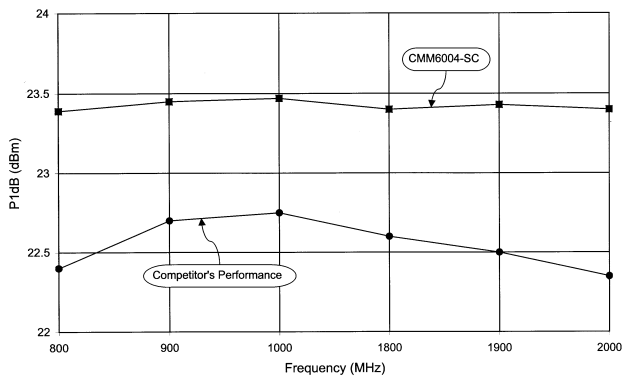

Gain vs Temperature at 900 MHz

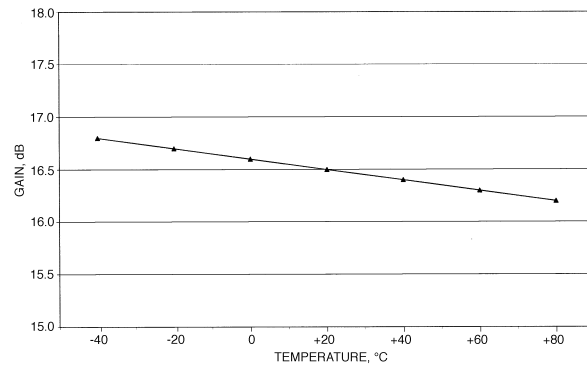

# 0.05-3.0 GHz High Dynamic Range Amplifier

## Application Circuit - 900 MHz

Typical Performance (50 Ohm System)

	5V	3.3V
Frequency	900 MHz	900 MHz
Gain	16.5 dB	16.2 dB
Input Return Loss	-18.0 dB	-19.0 dB
Output Return Loss	-14.0 dB	-16.0 dB
OIP3	41.0 dBm	38.0 dBm
Noise Figure	1.8 dB	1.8 dB
Drain Current	$I_d = 173 \text{ mA}$	$I_d = 173 \text{ mA}$
P1dB	23.8 dBm	18.5 dBm

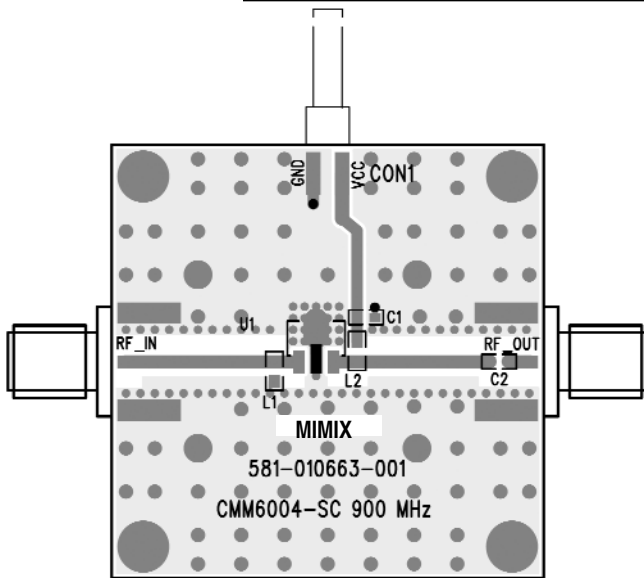
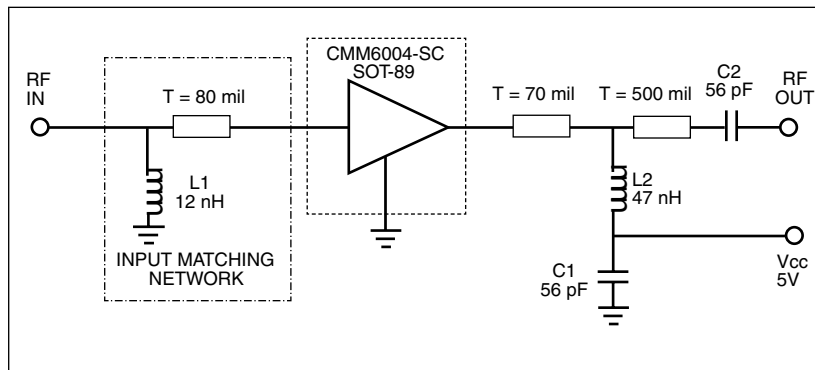
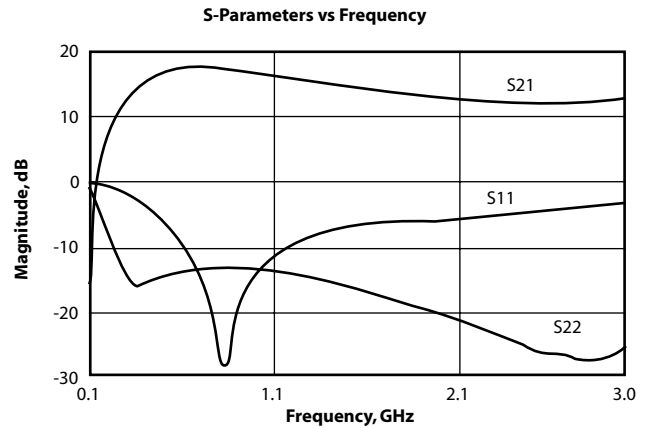

Ref Designator	Value	Description	Size
C1, C2	56 pF	MCH185A560JK	0603
L1	12 nH	TOKO LL1608-F12NK	0603
L2	47 nH	TOKO LL1608-F47NK	0603

# 0.05-3.0 GHz High Dynamic Range Amplifier

April 2009 - Rev 16-Apr-09



**CMM6004-SC**  
RoHS

## Typical Performance Over Voltage

CMM6004-SC Evaluation board @ 900MHz  
S21 Over Voltage

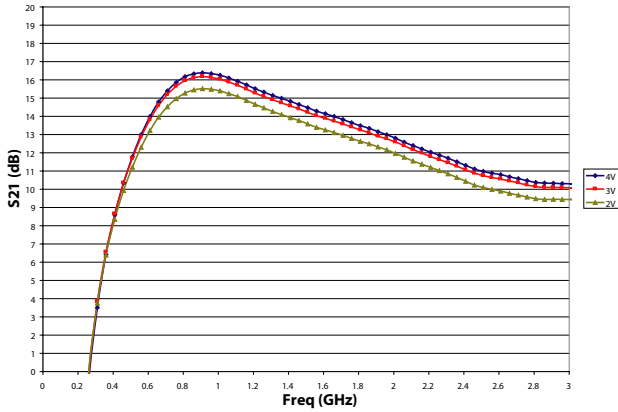

CMM6004-SC Evaluation board @ 900MHz  
S11 Over Voltage

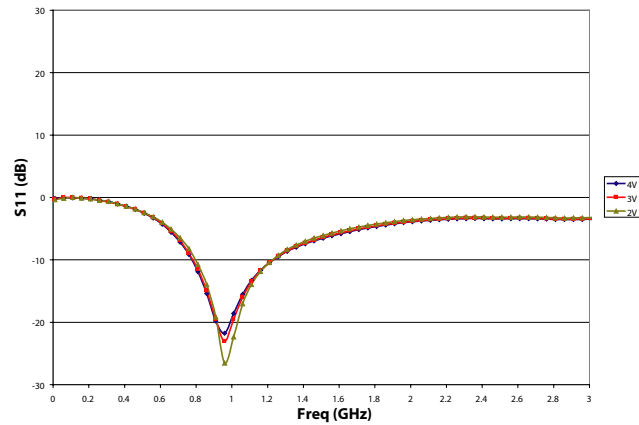

CMM6004-SC Evaluation board @ 900MHz  
S22 Over Voltage

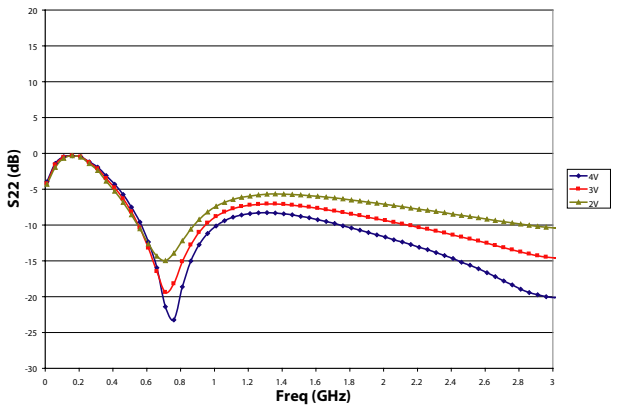

CMM6004-SC Evaluation board @ 900MHz  
P1dB Over Voltage

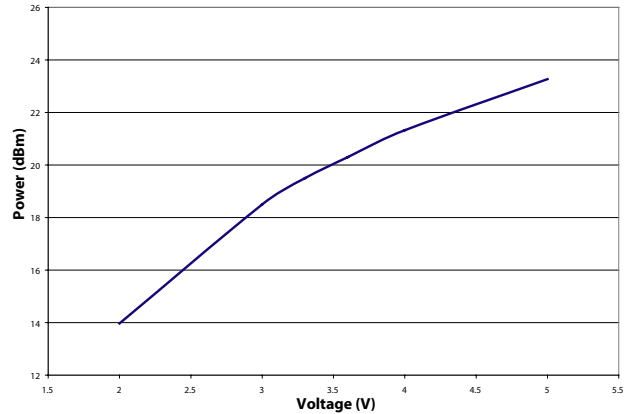

CMM6004-SC Evaluation board @ 900MHz  
OIP3 Over Voltage

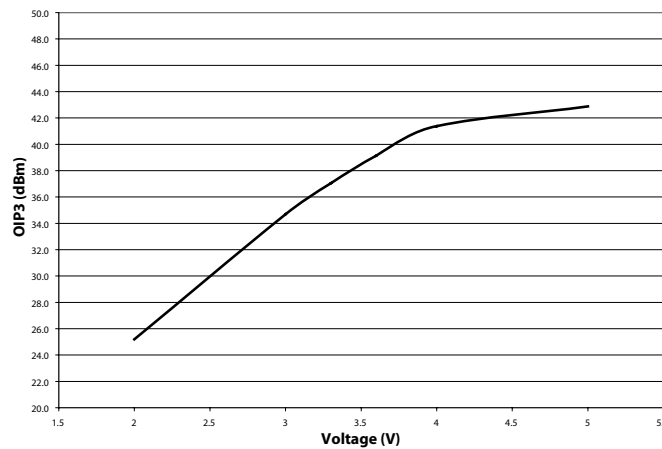

# 0.05-3.0 GHz High Dynamic Range Amplifier



April 2009 - Rev 16-Apr-09

**CMM6004-SC**  
RoHS

## Distribution Charts @ 3.3V

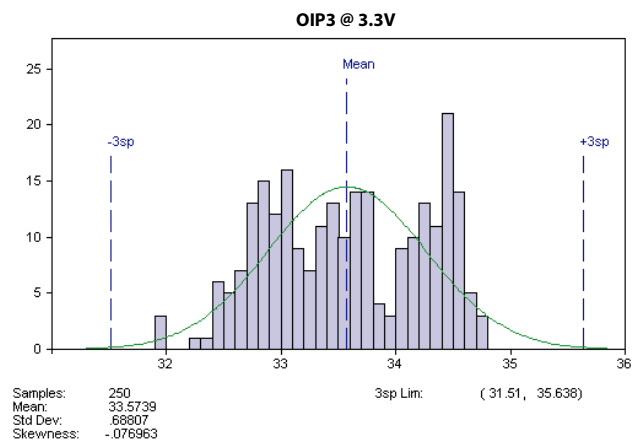
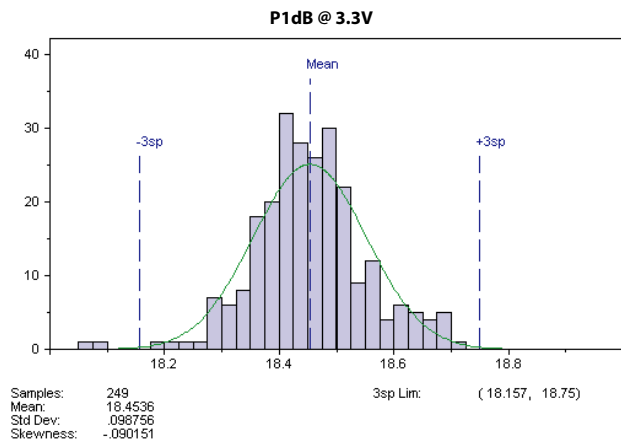
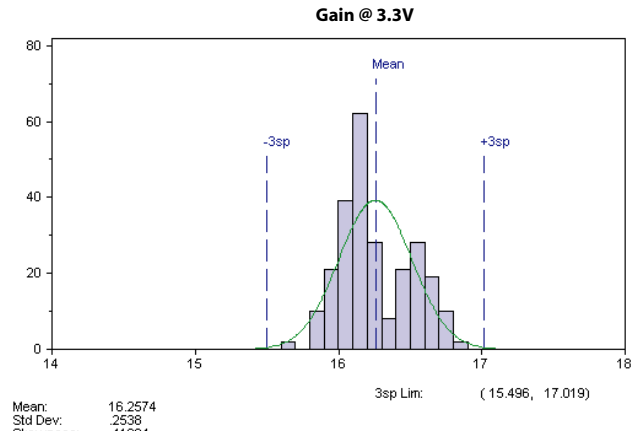
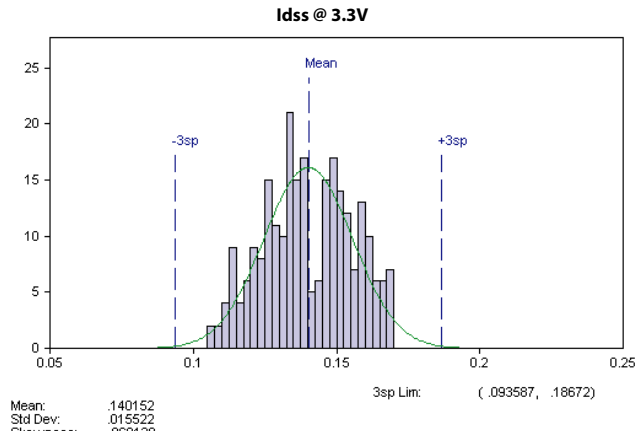

**Note: Sample size is 250 samples taken from 3 different wafer lots.**

# 0.05-3.0 GHz High Dynamic Range Amplifier

April 2009 - Rev 16-Apr-09

## Application Circuit - 1900 MHz

Typical Performance (50 Ohm System)

Frequency	1900 MHz
Gain	14.5 dB
Input Return Loss	-15 dB
Output Return Loss	-10 dB
OIP3	41.0 dBm
Noise Figure	2.2 dB
Bias	V <sub>ds</sub> = 5V, I <sub>d</sub> = 174 mA
P1dB	23.5 dBm

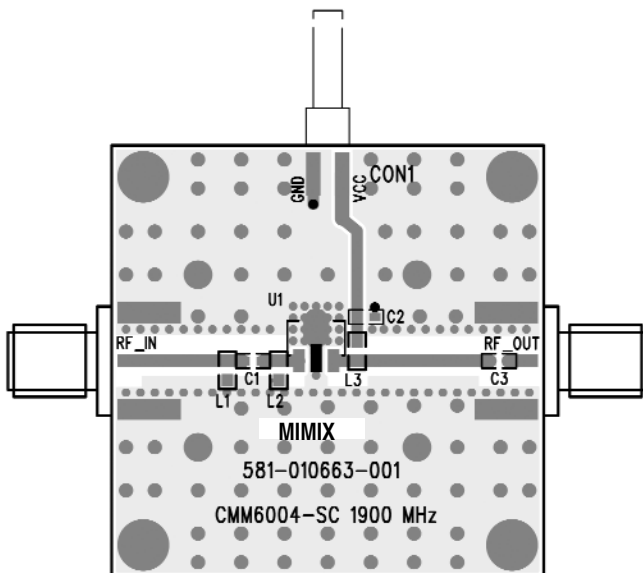
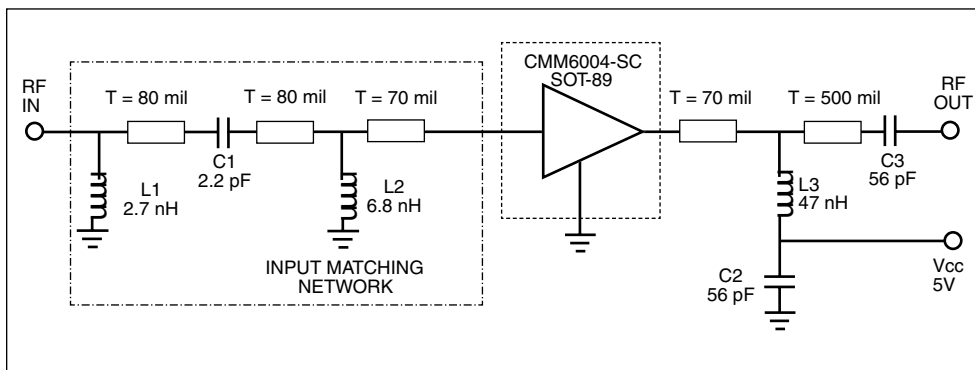
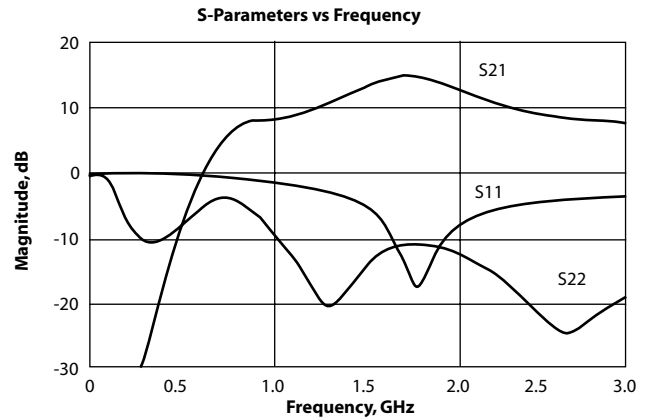

Ref Designator	Value	Description	Size
C1	2.2 pF	KOA 2.2pF 50V CER CAP 0603 NPO ±.25pF	0603
C2, C3	56 pF	MCH185A560JK	0603
L1	2.7 nH	TOKO LL1608-F2N7S	0603
L2	6.8 nH	TOKO LL1608-F6N8K	0603
L3	47 nH	TOKO LL1608-F47NK	0603

# 0.05-3.0 GHz High Dynamic Range Amplifier

April 2009 - Rev 16-Apr-09

## Application Circuit - 2400 MHz

Typical Performance (50 Ohm System)

Frequency	2400 MHz
Gain	13.6 dB
Input Return Loss	-15 dB
Output Return Loss	-12 dB
OIP3	41.0 dBm
Noise Figure	2.3 dB
Bias	V <sub>ds</sub> = 5V, I <sub>d</sub> = 175 mA
P1dB	23.0 dBm

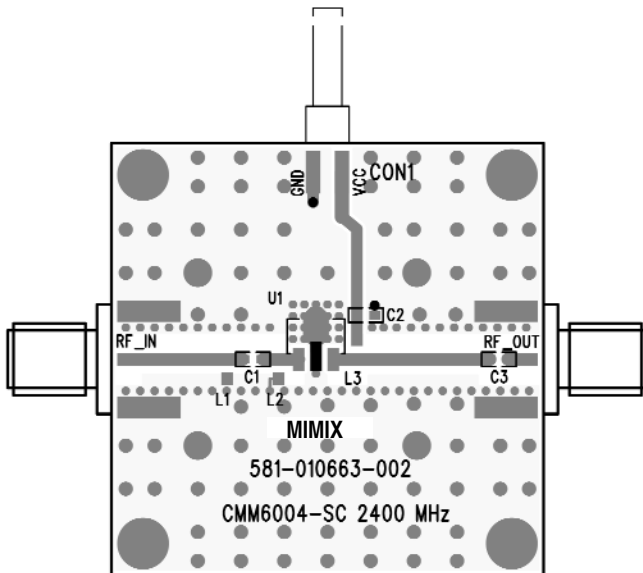
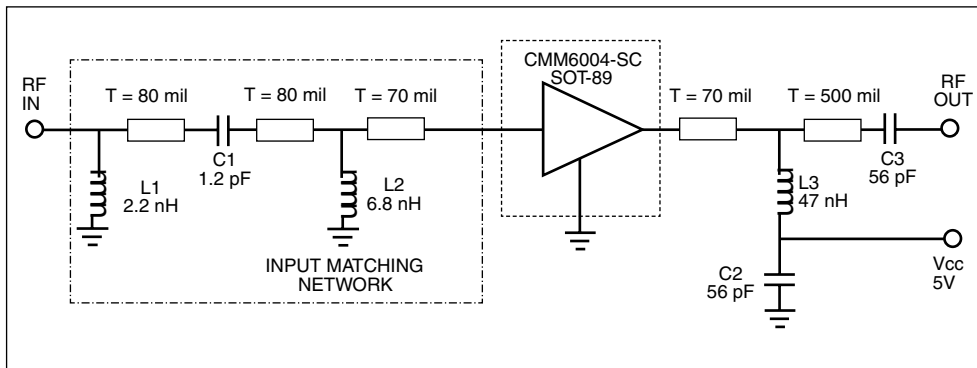
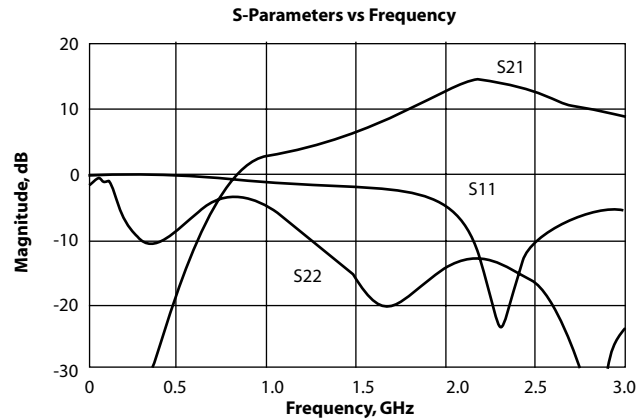

Ref Designator	Value	Description	Size
C1	1.2 pF	PHYC 1.2pF 50V CER CAP 0603 NPO ±.25pF	0603
C2, C3	56 pF	MCH185A560JK	0603
L1	2.2 nH	TOKO LL1608-F2N2S	0603
L2	6.8 nH	TOKO LL1608-F6N8K	0603
L3	47 nH	TOKO LL1608-F47NK	0603

# 0.05-3.0 GHz High Dynamic Range Amplifier

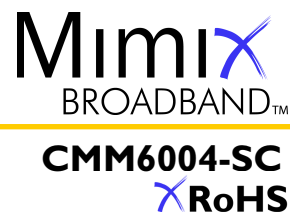

April 2009 - Rev 16-Apr-09

**CMM6004-SC**  
RoHS

## Typical Scattering Parameters

(V<sub>ds</sub> = +5V, I<sub>ds</sub> = 150 mA, T = 22°C, unmatched device in a 50 ohm system)

Frequency (MHz)	S <sub>11</sub>		S <sub>21</sub>		S <sub>12</sub>		S <sub>22</sub>	
	(Mag)	(Ang)	(Mag)	(Ang)	(Mag)	(Ang)	(Mag)	(Ang)
300	0.337	-47.270	7.379	157.500	0.066	-3.397	0.067	-164.10
400	0.349	-58.240	7.259	151.400	0.066	-6.123	0.064	-173.50
500	0.363	-68.990	7.127	145.300	0.066	-8.429	0.062	-179.70
600	0.379	-79.290	6.986	139.300	0.066	-10.740	0.060	-173.90
700	0.396	-89.000	6.829	133.300	0.065	-12.900	0.059	-169.10
800	0.413	-98.120	6.666	127.400	0.065	-14.990	0.057	-165.00
900	0.430	-106.700	6.502	121.600	0.065	-16.990	0.055	-161.60
1000	0.447	-114.700	6.330	115.900	0.065	-18.970	0.053	-158.60
1100	0.467	-122.400	6.162	110.300	0.065	-20.840	0.052	-155.50
1200	0.475	-129.600	5.991	104.900	0.065	-22.900	0.049	-152.50
1300	0.490	-136.500	5.820	99.610	0.065	-24.660	0.047	-150.10
1400	0.502	-143.100	5.655	94.400	0.065	-26.510	0.046	-147.00
1500	0.513	-149.400	5.494	89.350	0.064	-28.490	0.044	-144.30
1600	0.524	-155.500	5.339	84.370	0.064	-30.130	0.042	-141.50
1700	0.534	-161.400	5.189	79.490	0.064	-32.120	0.041	-138.80
1800	0.543	-167.100	5.045	74.690	0.064	-34.010	0.040	-136.00
1900	0.551	-172.60	4.906	69.960	0.064	-35.800	0.039	-133.00
2000	0.559	-178.000	4.775	65.320	0.064	-37.620	0.038	-130.00
2100	0.565	176.800	4.647	60.730	0.064	-39.550	0.037	-127.20
2200	0.571	171.500	4.523	56.180	0.064	-41.370	0.037	-124.10
2300	0.577	166.400	4.402	51.720	0.064	-43.200	0.036	-119.80
2400	0.582	161.400	4.289	47.320	0.064	-45.090	0.035	-116.00
2500	0.588	156.500	4.183	42.960	0.064	-46.900	0.036	-111.50
2600	0.539	151.600	4.081	38.610	0.065	-48.790	0.035	-106.20
2700	0.597	146.800	3.983	34.330	0.065	-50.760	0.035	-101.30
2800	0.600	142.000	3.886	30.050	0.065	-52.670	0.036	-95.96
2900	0.605	137.200	3.795	25.810	0.065	-54.540	0.037	-90.92
3000	0.608	132.500	3.706	21.620	0.065	-56.660	0.038	-85.54

S-Parameter Data Files are available online at [www.mimixbroadband.com](http://www.mimixbroadband.com).



# 0.05-3.0 GHz High Dynamic Range Amplifier

April 2009 - Rev 16-Apr-09



**CMM6004-SC**  
RoHS

## Physical Dimensions

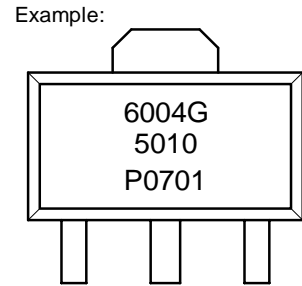
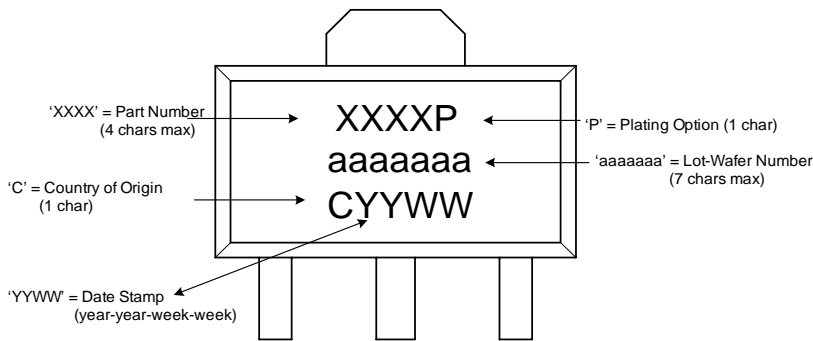
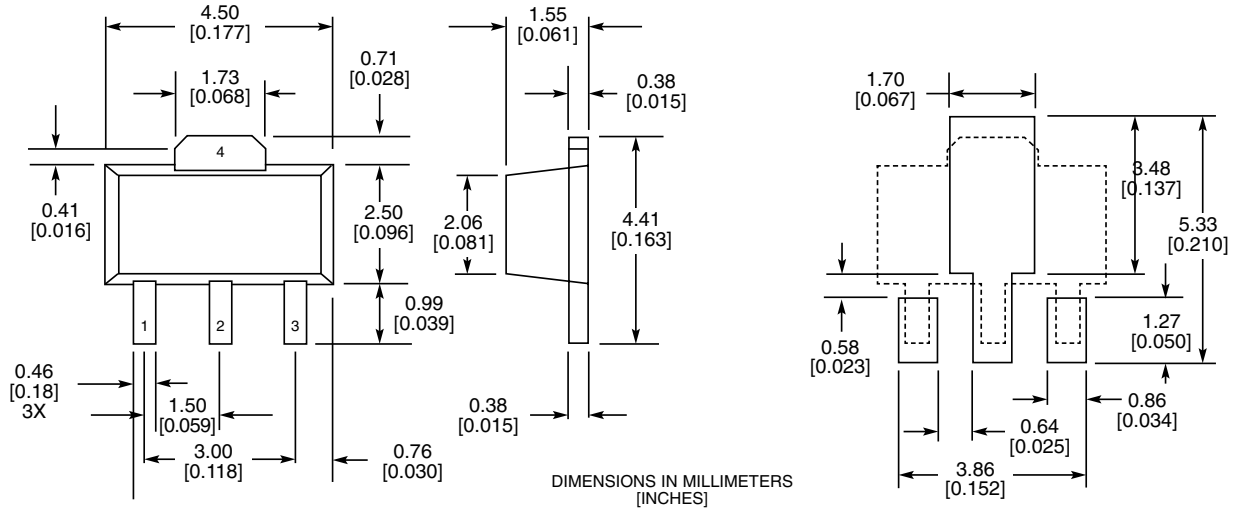

Base Part #: 6004  
Lot-Wafer #: 5010  
Plating Option: G (matte tin)  
Date Code: 2007, week 1  
Country of Origin: Philippines

## MTTF

These numbers were calculated based on accelerated life test information received from the fabrication foundry and measured thermal resistance.

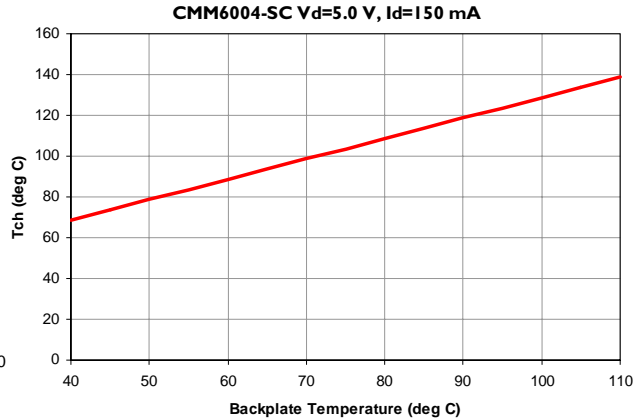
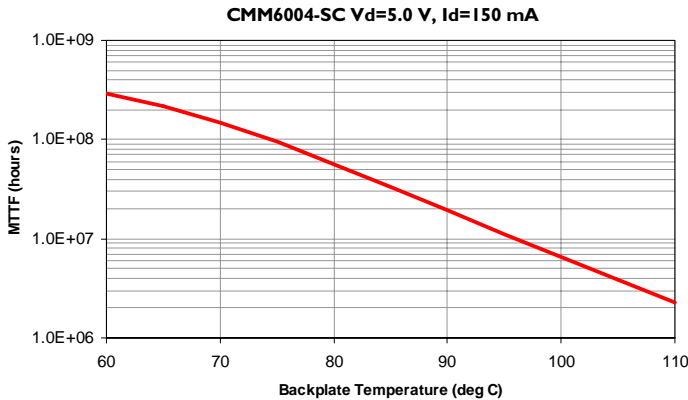

# 0.05-3.0 GHz High Dynamic Range Amplifier

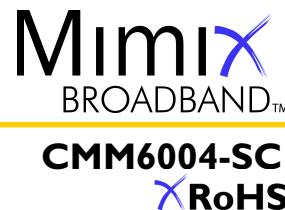

April 2009 - Rev 16-Apr-09

## Handling and Assembly Information

**CAUTION!** - Mimix Broadband MMIC Products contain gallium arsenide (GaAs) which can be hazardous to the human body and the environment. For safety, observe the following procedures:

- Do not ingest.
- Do not alter the form of this product into a gas, powder, or liquid through burning, crushing, or chemical processing as these by-products are dangerous to the human body if inhaled, ingested, or swallowed.
- Observe government laws and company regulations when discarding this product. This product must be discarded in accordance with methods specified by applicable hazardous waste procedures.

**Life Support Policy** - Mimix Broadband's products are not authorized for use as critical components in life support devices or systems without the express written approval of the President and General Counsel of Mimix Broadband. As used herein: (1) Life support devices or systems are devices or systems which, (a) are intended for surgical implant into the body, or (b) support or sustain life, and whose failure to perform when properly used in accordance with instructions for use provided in the labeling, can be reasonably expected to result in a significant injury to the user. (2) A critical component is any component of a life support device or system whose failure to perform can be reasonably expected to cause the failure of the life support device or system, or to affect its safety or effectiveness.

**Package Attachment** - This packaged product from Mimix Broadband is provided as a rugged surface mount package compatible with high volume solder installation. Care should be taken not to apply heavy pressure to the top or base material to avoid package damage. Vacuum tools or other suitable pick and place equipment may be used to pick and place this part. Care should be taken to ensure that there are no voids or gaps in the solder connection so that good RF, DC and ground connections are maintained. Voids or gaps can eventually lead not only to RF performance degradation, but reduced reliability and life of the product due to thermal stress.

**Mimix Lead-Free RoHS Compliant Program** - Mimix has an active program in place to meet customer and governmental requirements for eliminating lead (Pb) and other environmentally hazardous materials from our products. All Mimix RoHS compliant components are form, fit and functional replacements for their non-RoHS equivalents. Lead plating of our RoHS compliant parts is 100% matte tin (Sn) over copper alloy and is backwards compatible with current standard SnPb low-temperature reflow processes as well as higher temperature (260°C reflow) "Pb Free" processes.

## Ordering Information

The CMM6004-SC is available in a surface-mount SOT-89 package and devices are available in tape and reel.

<u>Part Number for Ordering</u>	<u>Description</u>
CMM6004-SC-0G00	Matte Tin finished RoHS compliant SOT-89 surface-mount power package in bulk quantity
CMM6004-SC-0G0T	Matte Tin finished RoHS compliant SOT-89 surface-mount power package in tape and reel
PB-CMM6004-SC-00A0	Evaluation Board with SMA connectors for CMM6004-SC matched at 900 MHz
PB-CMM6004-SC-00B0	Evaluation Board with SMA connectors for CMM6004-SC matched at 1900 MHz
PB-CMM6004-SC-00C0	Evaluation Board with SMA connectors for CMM6004-SC matched at 2400 MHz

We also offer the plastic package with SnPb (Tin-Lead) or NiPdAu plating. Please contact your regional sales manager for more information regarding different plating types.



Proper ESD procedures should be followed when handling this device.

Mimix Broadband, Inc., 10795 Rockley Rd., Houston, Texas 77099  
Tel: 281.988.4600 Fax: 281.988.4615 mimixbroadband.com

Page 10 of 10

Characteristic Data and Specifications are subject to change without notice. ©2009 Mimix Broadband, Inc.  
Export of this item may require appropriate export licensing from the U.S. Government. In purchasing these parts, U.S. Domestic customers accept their obligation to be compliant with U.S. Export Laws.