

## Low Noise Amplifier 0.1-3.5 GHz

Rev. V2

### Features

- Single Voltage Supply 3V ~ 5V
- Integrated Active Bias Circuit
- Adjustable Current with an External Resistor
- Low Noise Figure
- High Linearity OIP3, 34 dBm @ 2 GHz
- Broadband Match
- Integrated ESD Protection
- RoHS\* Compliant and 260°C Reflow Compatible

### Description

The MAAL-010704 is a high dynamic range single stage MMIC LNA with excellent linearity and low noise figure designed for operation from 0.1 to 3.5 GHz. The LNA is packaged in an RoHS compliant SOT-363 package and requires no external matching components.

This MMIC has an integrated active bias circuit allowing direct connection to +3.0 V supply and minimizing variation over temperature and process. The bias current can be set with an external resistor to allow the user to customize the current value to fit the application.

The MAAL-010704 offers less than 1 dB noise figure and 34 dBm OIP3 at 2 GHz. The broadband match and single supply operation makes this LNA easy to use and simplifies its implementation while maintaining excellent performance. The low thermal resistance and integrated ESD protection significantly enhances the quality, reliability and ruggedness of this product.

### Functional Block Diagram

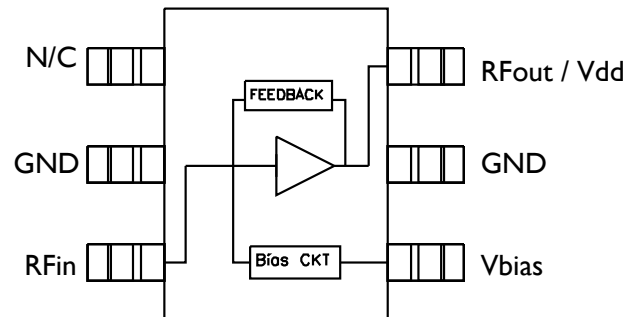

### Pin Configuration<sup>1</sup>

Pin No.	Pin Name	Description
1	N/C	No Connection
2	GND	Ground
3	RF <sub>IN</sub>	RF Input
4	V <sub>BIAS</sub>	Bias Voltage
5	GND	Ground
6	RF <sub>OUT</sub>	RF Output

1. It is recommended that all N/C pins be grounded.

### Ordering Information<sup>2,3</sup>

Part Number	Package
MAAL-010704-000000	bulk quantity
MAAL-010704-TR3000	tape and reel
MAAL-010704-001SMB	evaluation board (100 MHz ~ 3.5 GHz)

2. Reference Application Note M513 for reel size information.

3. All sample boards include 5 loose parts.

\* Restrictions on Hazardous Substances, European Union Directive 2002/95/EC.

1

**ADVANCED:** Data Sheets contain information regarding a product M/A-COM Technology Solutions is considering for development. Performance is based on target specifications, simulated results, and/or prototype measurements. Commitment to develop is not guaranteed.

**PRELIMINARY:** Data Sheets contain information regarding a product M/A-COM Technology Solutions has under development. Performance is based on engineering tests. Specifications are typical. Mechanical outline has been fixed. Engineering samples and/or test data may be available. Commitment to produce in volume is not guaranteed.

• **North America** Tel: 800.366.2266 • **Europe** Tel: +353.21.244.6400

• **India** Tel: +91.80.43537383 • **China** Tel: +86.21.2407.1588

Visit [www.macomtech.com](http://www.macomtech.com) for additional data sheets and product information.

M/A-COM Technology Solutions Inc. and its affiliates reserve the right to make changes to the product(s) or information contained herein without notice.

## Low Noise Amplifier 0.1-3.5 GHz

Rev. V2

### Typical Performance <sup>4,5</sup>: $V_{DD} = 3.0\text{ V}$ , $I_{DD} = 60\text{ mA}$ , $I_{BIAS} = 8\text{ mA}$ , $25\text{ }^{\circ}\text{C}$

Parameter	Units	TYP	TYP	TYP	TYP	TYP	TYP	TYP	TYP	TYP
Frequency (F)	GHz	0.2	0.5	0.8	1.0	1.5	2.0	2.5	3.0	3.5
Gain (S21)	dB	22.0	21.5	19.5	18.5	16.0	14.0	12.5	11.0	10.0
Output IP3 (OIP3)	dBm	33.2	34.9	36.7	33.7	34.0	34.5	35.0	36.7	37.2
Output P1dB (P1dB)	dBm	17.0	18.0	18.6	18.3	18.8	19.1	19.0	19.1	18.4
Input Return Loss (S11)	dB	-11.0	-13.0	-13.0	-12.7	-12.0	-11.4	-10.5	-10.0	-9.1
Output Return Loss (S22)	dB	-19.0	-26.0	-23.0	-22.0	-20.5	-20.5	-20.0	-19.5	-20.0
Noise Figure (NF)	dB	0.70	0.80	0.75	0.74	0.75	0.84	0.93	1.10	1.20

### Typical Performance <sup>4,5</sup>: $V_{DD} = 5.0\text{ V}$ , $I_{DD} = 60\text{ mA}$ , $I_{BIAS} = 8\text{ mA}$ , $25\text{ }^{\circ}\text{C}$

Parameter	Units	TYP	TYP	TYP	TYP	TYP	TYP	TYP	TYP	TYP
Frequency (F)	GHz	0.2	0.5	0.8	1.0	1.5	2.0	2.5	3.0	3.5
Gain (S21)	dB	22.0	21.5	19.5	18.5	16.0	14.0	12.5	11.0	10.0
Output IP3 (OIP3)	dBm	31.8	34.0	35.0	36.5	36.2	36.5	37.1	37.6	36.8
Output P1dB (P1dB)	dBm	22.0	21.0	22.0	21.9	22.2	22.2	22.4	22.4	22.1
Input Return Loss (S11)	dB	-11.0	-13.0	-13.0	-12.7	-12.0	-11.5	-10.5	-10.0	-9.0
Output Return Loss (S22)	dB	-22.0	-26.0	-20.0	-19.0	-17.5	-17.0	-17.0	-16.5	-17.0
Noise Figure (NF)	dB	0.80	0.84	0.80	0.78	0.80	0.90	1.0	1.16	1.28

4. Typical values presented in the above table were obtained by measurements using RF probes in a 50 ohm system.

5. Pout = 5 dBm, Tone Spacing = 1 MHz

### Electrical Specifications <sup>6,7</sup>: $2\text{ GHz}$ ( $T = 25\text{ }^{\circ}\text{C}$ , $V_{DD} = 3\text{ V}$ , $Z_0 = 50\text{ }\Omega$ )

Parameter	Units	Min.	Typ.	Max.
Small Signal Gain (S21)	dB	12.5	14.3	-
Output Intercept Point (OIP3)	dBm	-	+34.5	-
Output P1dB	dBm	17.0	+18.6	-
Quiescent Current (Idd)	mA	-	60.0	75.0
Noise Figure (NF)	dB	-	0.95	-

6. Unless otherwise specified, the specifications are guaranteed at room temperature in a M/A-COM Technology Solutions test fixture.

7. Typical values presented in the above table are based on data from multiple wafer lots and evaluation board MAAL-010704-001SMB.

### Absolute Maximum Ratings<sup>8,9</sup>

Parameter	Absolute Max.
Supply Voltage ( $V_{DD}$ )	+5.5 V
Current ( $I_{dq}$ )	100 mA
Bias Current ( $I_{bias}$ )	15 mA
Power Dissipation ( $P_{dis}$ )	600 mW
RF Input Power ( $P_{in}$ )	+24 dBm
Storage Temperature ( $T_{stg}$ )	-55 to +150 °C
Operating Temperature ( $T_a$ )	-40 to +85 °C
Junction Temperature	150 °C
Thermal Resistance	104 °C/W
ESD (HBM)	Class 1A
Moisture Sensitivity Level	MSL1

- Exceeding any one or combination of these limits may cause permanent damage to this device.
- M/A-COM Technology Solutions does not recommend sustained operation near these survivability limits.

### Component Values

Ref Designator	Description
C1, C4, C5	1 nF 0402 Capacitor
C6	10 nF 0402 Capacitor
C9	100 $\mu$ F Tantalum Capacitor Size C
L2	82 nH 0402 Inductor
L3 or R1 <sup>10</sup>	Please refer to $R_{bias}$ Vs $I_{DQ}$ plot to select the appropriate R1 value
C2, C3, C7, C8, L1, L3	DNP

- $V_{bias}$  can be connected separate of  $V_{DD}$  to control the drain current. When  $V_{bias}$  is connected directly either a resistor is used to drop the voltage down from 3V, or if the exact bias voltage (~2V) is applied, then an inductor L3 can be used.

### Evaluation Board Schematic

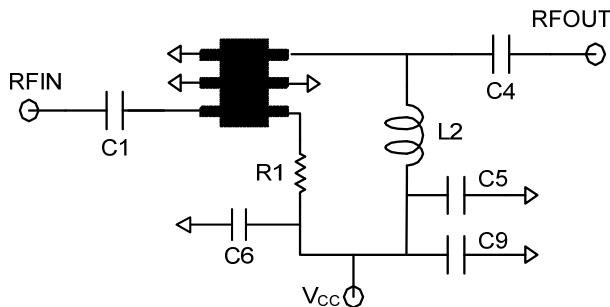

### Evaluation Board (MAAL-010704-001SMB)

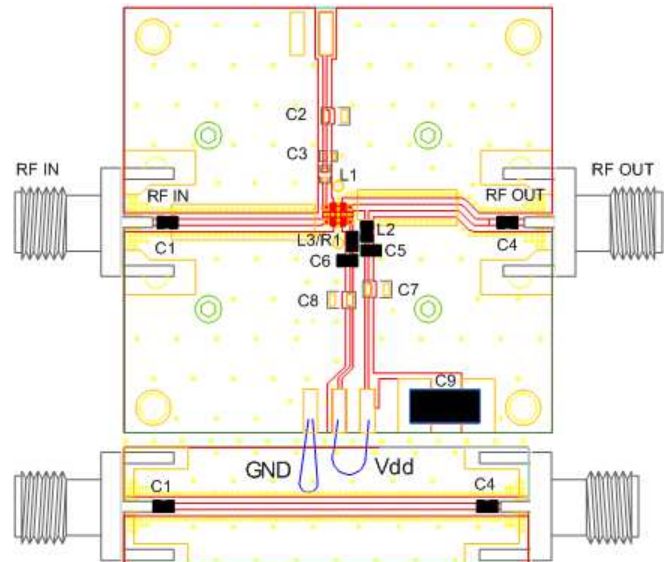

## Typical Performance: $R_{BIAS}$ vs. Current<sup>11</sup>

**IDQ vs.  $R_{BIAS}$  @ 3 V**

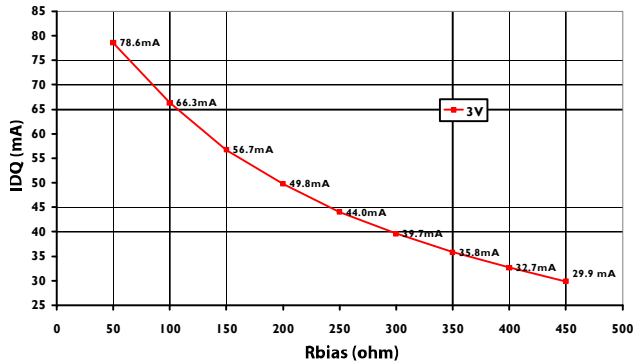

**IDQ vs.  $R_{BIAS}$  @ 5 V**

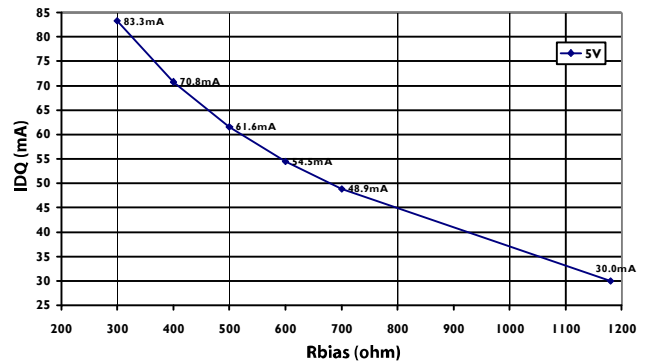

11. IDQ represents the total current of drain current ( $I_{DD}$ ) and bias current ( $I_{BIAS}$ ) combined. The resistor ( $R_{BIAS}$ ) is connected between pin 4 ( $V_{BIAS}$ ) and pin 6 (RF out /  $V_{DD}$ ).

## Typical Performance<sup>12</sup>: Total Current vs. Pout vs. Voltage

**IDQ = 30 mA**

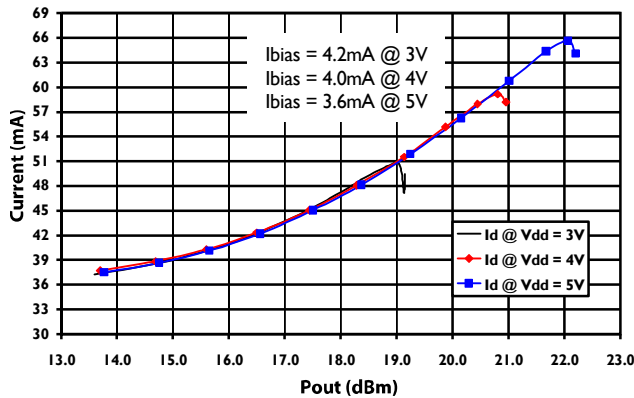

**IDQ = 60 mA**

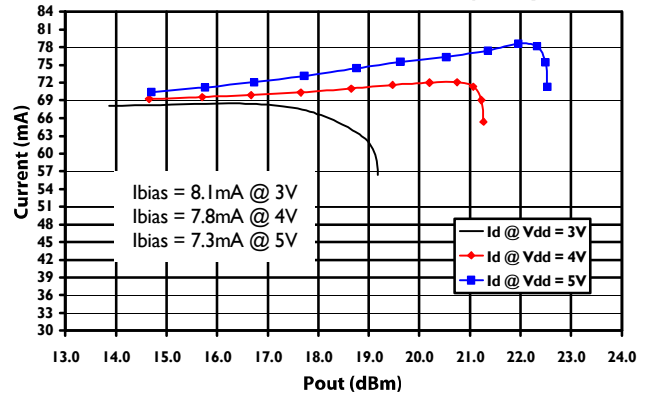

### Typical Performance Curves<sup>12</sup>: 3V, 30 mA (over temperature)

**Input Return Loss**

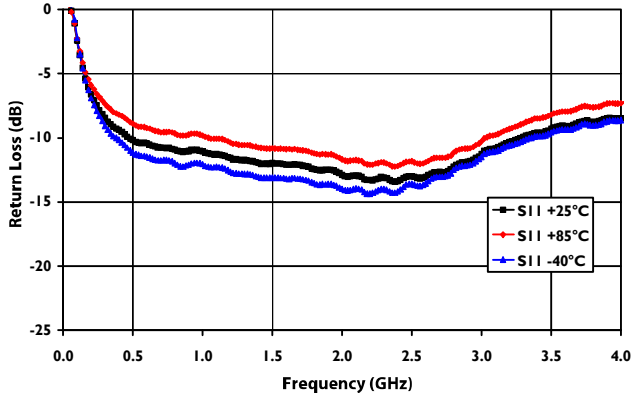

**Output Return Loss**

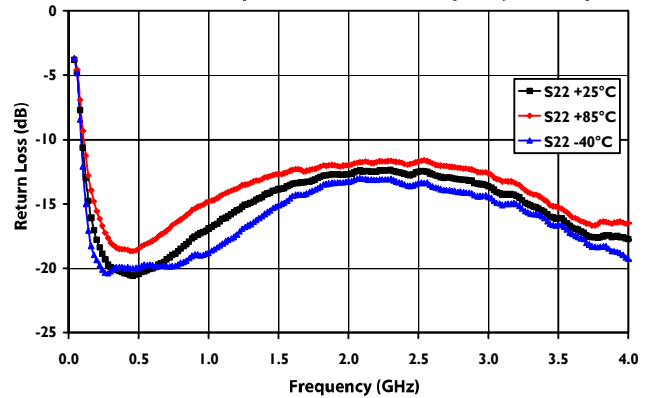

**Gain**

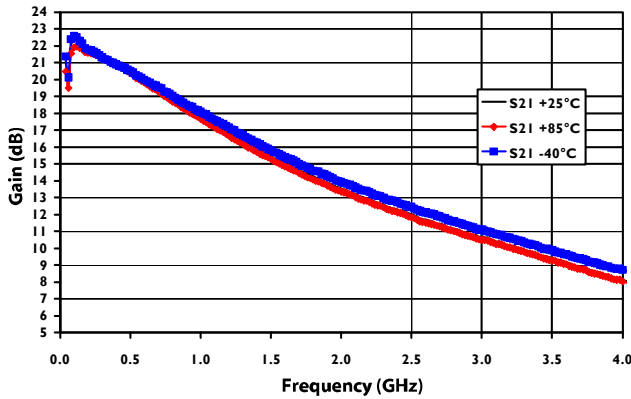

**Noise Figure**

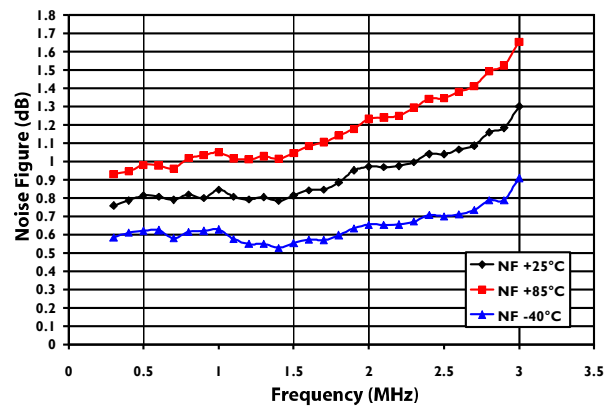

**OIP3**

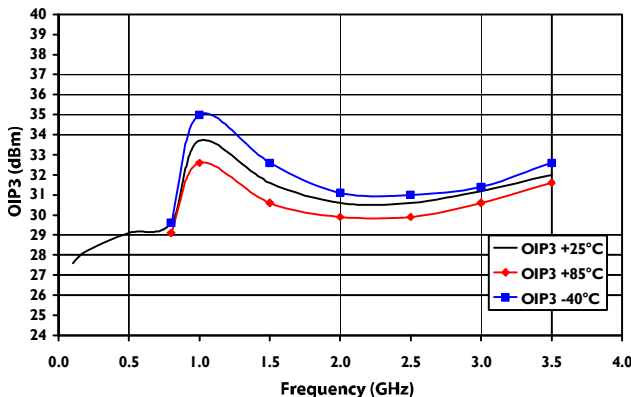

**P1dB**

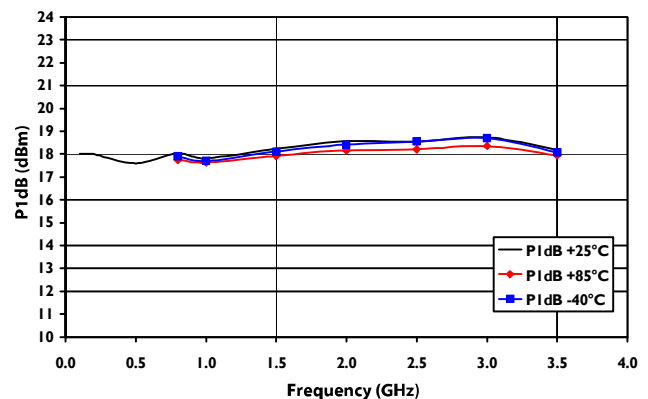

## Low Noise Amplifier 0.1-3.5 GHz

Rev. V2

### Typical Performance Curves<sup>12</sup>: 3V, 60 mA (over temperature)

**Input Return Loss**

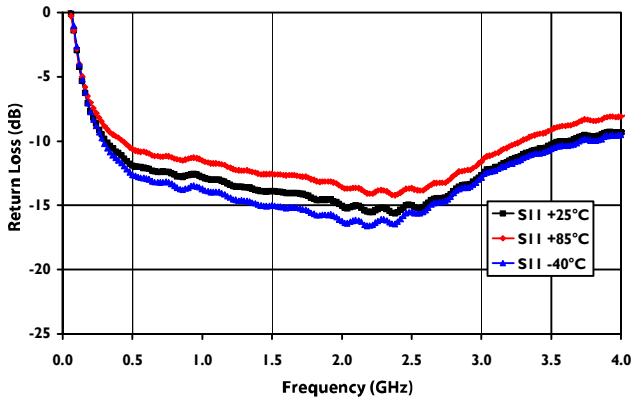

**Output Return Loss**

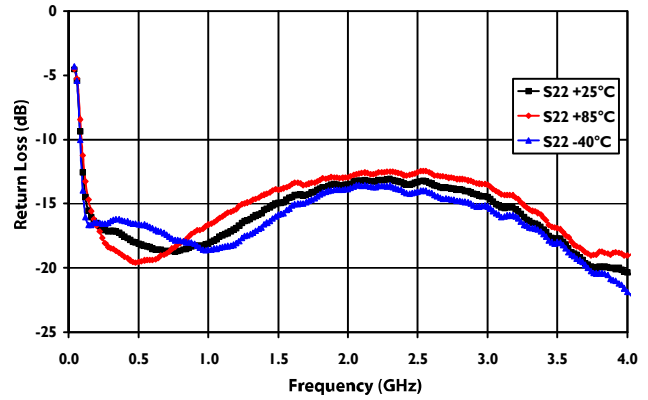

**Gain**

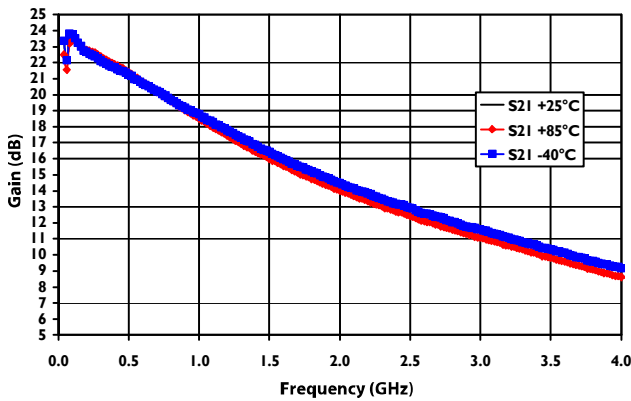

**Noise Figure**

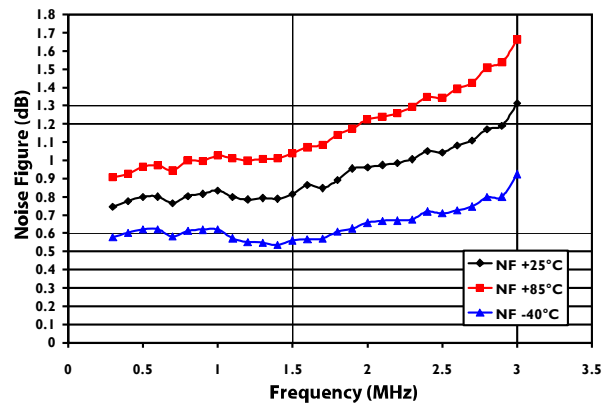

**OIP3**

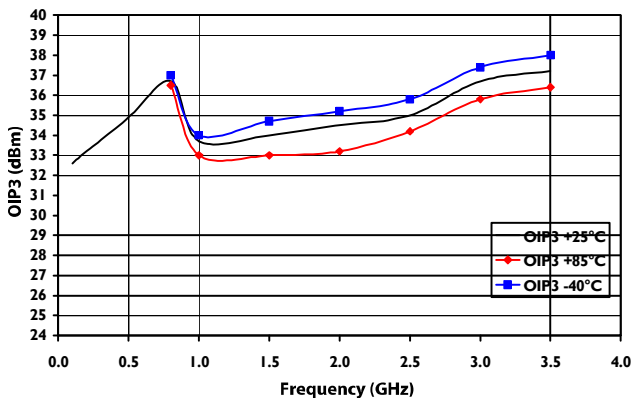

**P1dB**

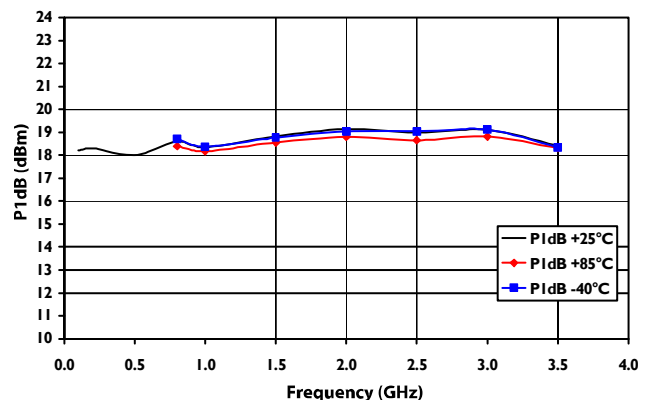

**ADVANCED:** Data Sheets contain information regarding a product M/A-COM Technology Solutions is considering for development. Performance is based on target specifications, simulated results, and/or prototype measurements. Commitment to develop is not guaranteed.

**PRELIMINARY:** Data Sheets contain information regarding a product M/A-COM Technology Solutions has under development. Performance is based on engineering tests. Specifications are typical. Mechanical outline has been fixed. Engineering samples and/or test data may be available. Commitment to produce in volume is not guaranteed.

• **North America** Tel: 800.366.2266 • **Europe** Tel: +353.21.244.6400  
 • **India** Tel: +91.80.43537383 • **China** Tel: +86.21.2407.1588  
 Visit [www.macomtech.com](http://www.macomtech.com) for additional data sheets and product information.

M/A-COM Technology Solutions Inc. and its affiliates reserve the right to make changes to the product(s) or information contained herein without notice.

## Low Noise Amplifier 0.1-3.5 GHz

Rev. V2

### Typical Performance Curves<sup>12</sup>: 5V, 30 mA (over temperature)

**Input Return Loss**

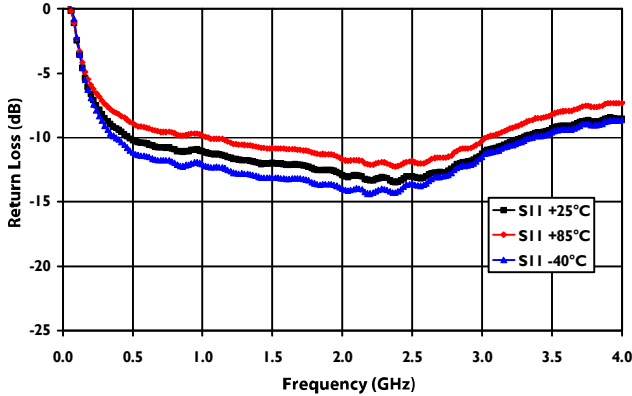

**Output Return Loss**

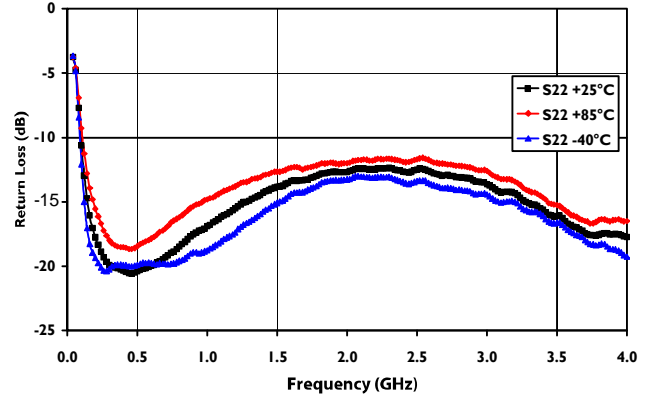

**Gain**

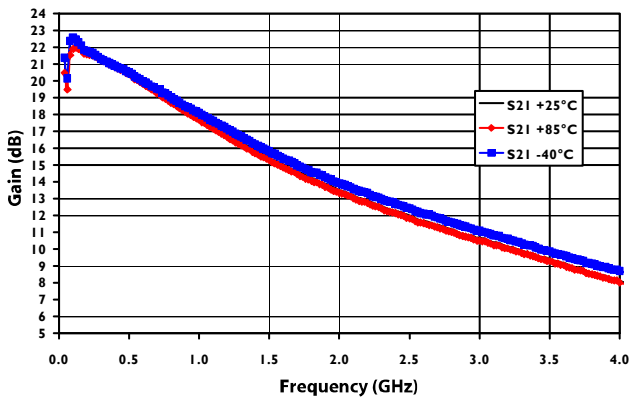

**Noise Figure**

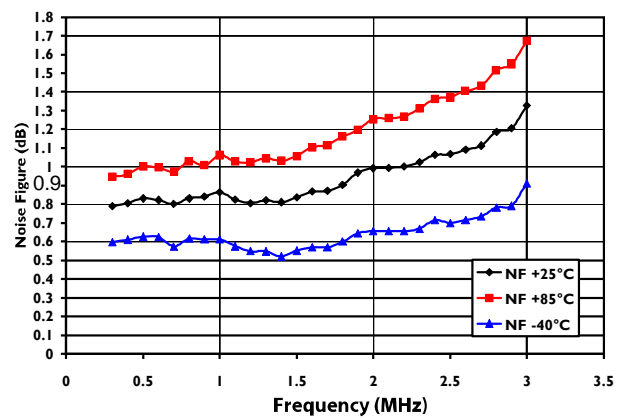

**OIP3**

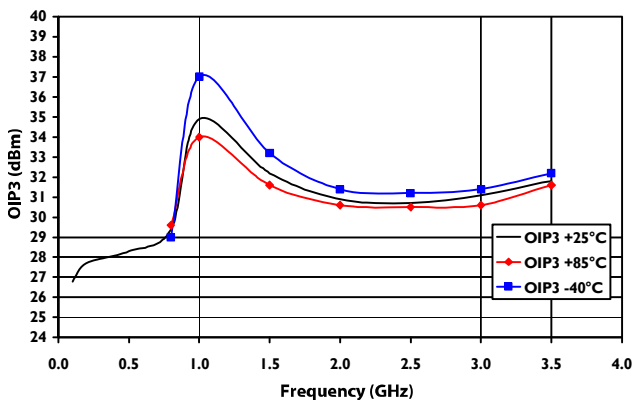

**P1dB**

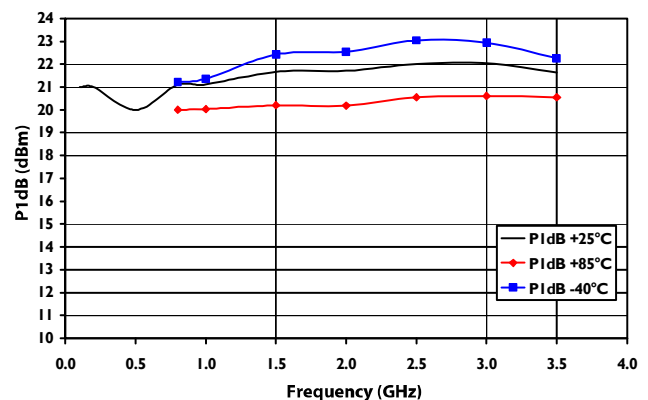

## Low Noise Amplifier 0.1-3.5 GHz

Rev. V2

### Typical Performance Curves<sup>12</sup>: 5V, 60 mA (over temperature)

**Input Return Loss**

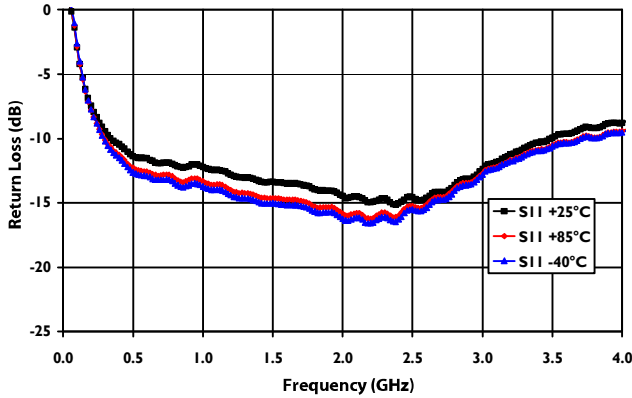

**Output Return Loss**

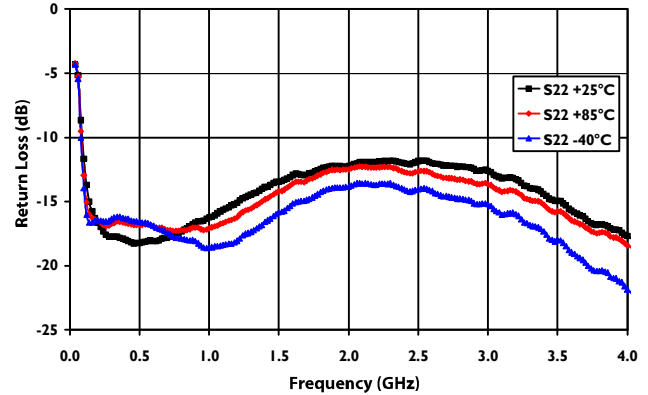

**Gain**

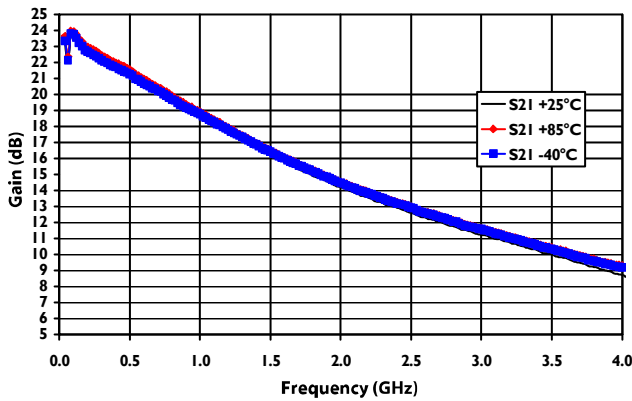

**Noise Figure**

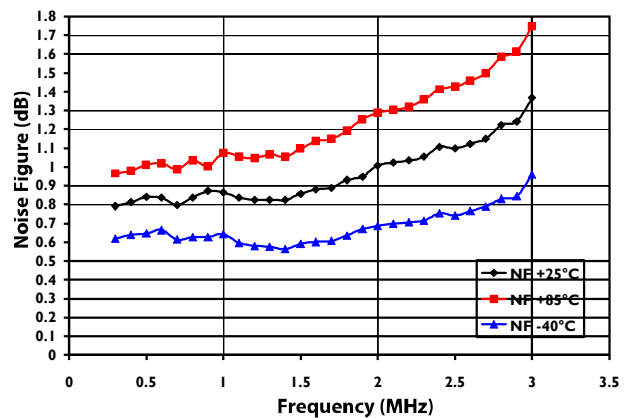

**OIP3**

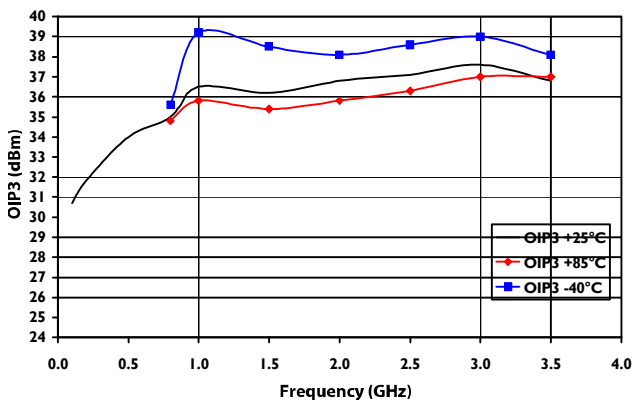

**P1dB**

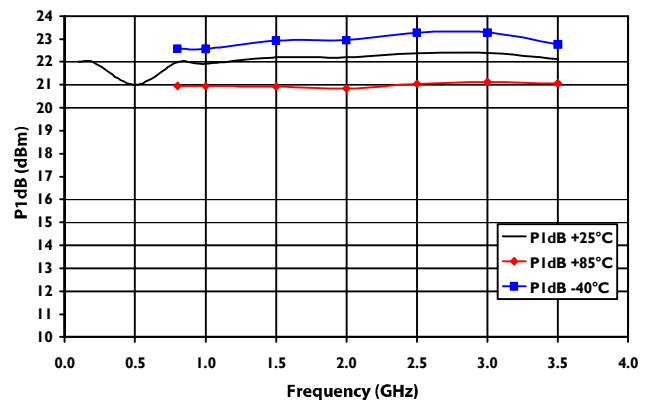

12. Graphs were generated using evaluation board MAAL-010704-001SMB.



## Typical S-Parameters<sup>13</sup>

**Reverse Isolation**

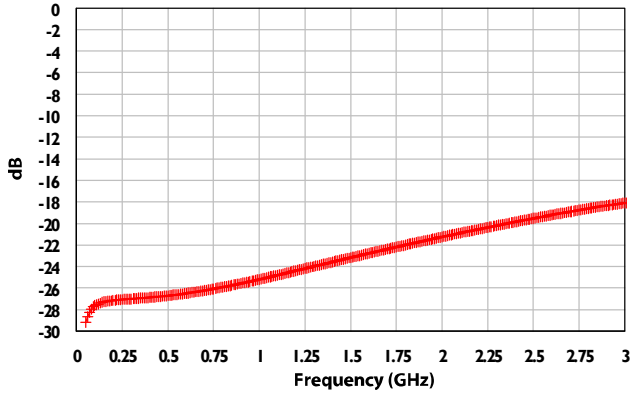

**Gain**

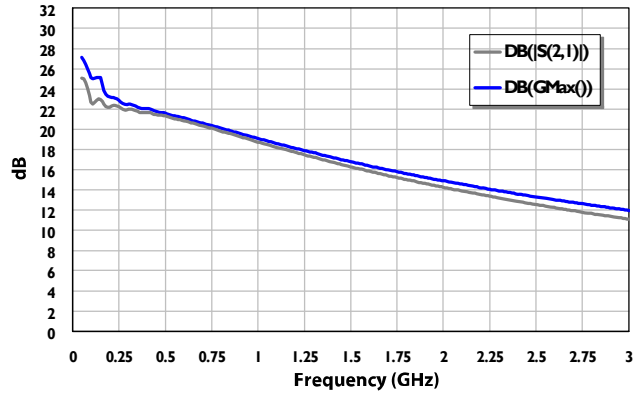

**Output Return Loss**

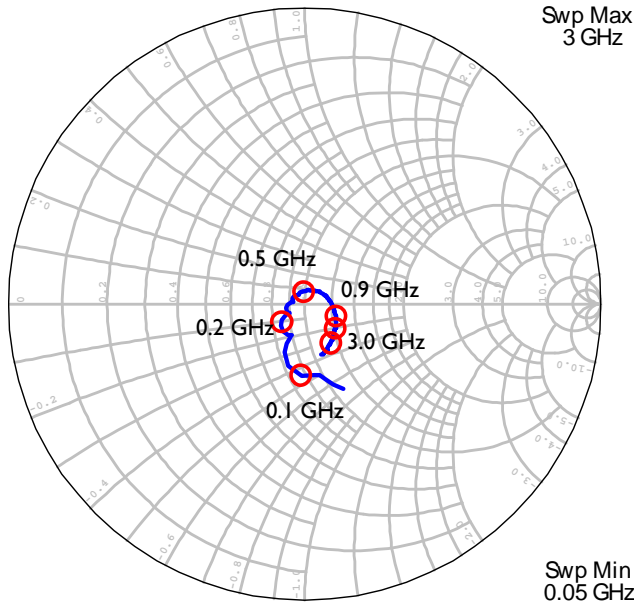

**Input Return Loss**

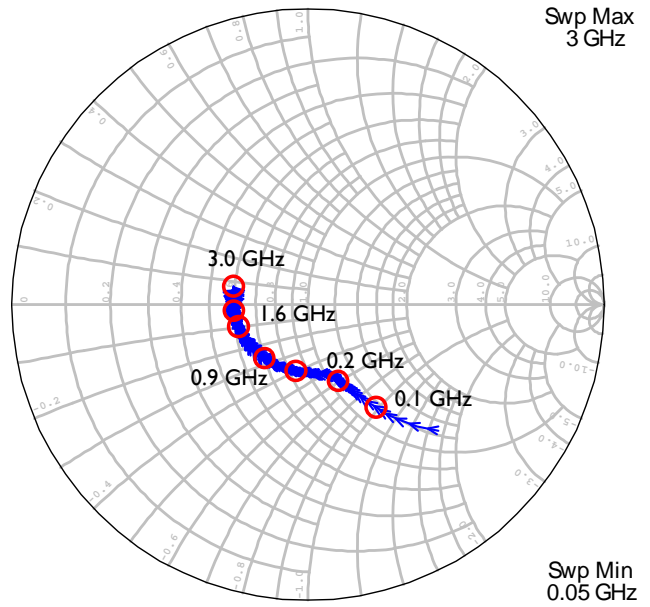

13. S-Parameters files in S2P format are available for download at [macomtech.com](http://macomtech.com).

### Evaluation Board Schematic @ 100 MHz

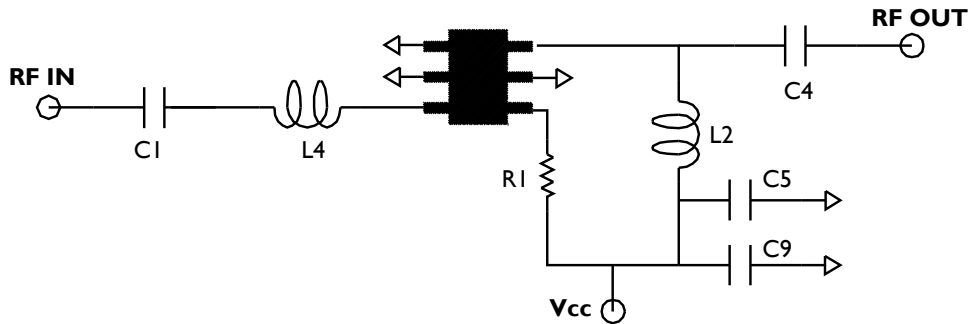

### Typical Performance: 3 V, 60 mA

Parameter	Units	TYP
Frequency	GHz	0.1
Gain	dB	25.5
Output IP3 <sup>14</sup>	dBm	31.5
Output P1dB	dBm	17.5
Input Return Loss	dB	-11.0
Output Return Loss	dB	-11.0
Noise Figure	dB	1.85

### Component Values

Ref Designator	Description
C1, C4	1 nF 0402 Capacitor
C5	10 nF 0402 Capacitor
C9	100 uF Tantalum Capacitor Size C
L2	150 nH 0603 Inductor
L4	68 nH 0402 Inductor
R1	Refer to Rbias Vs Idd plot
C2, C3, C6, C7, C8, L1, L3	DNP

14. Pout = 5 dBm, Tone Spacing = 1 MHz

### S-Parameters using 100 MHz evaluation board

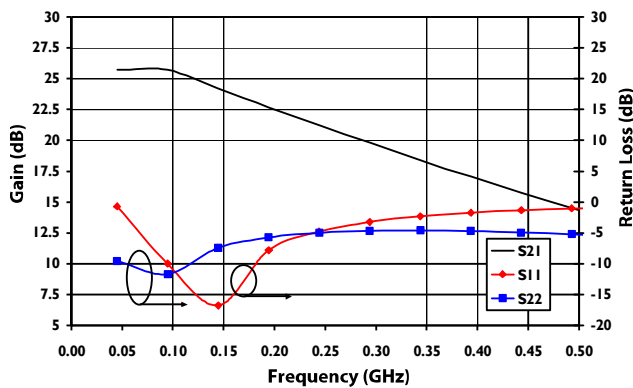

## Evaluation Board Schematic @ 200 MHz

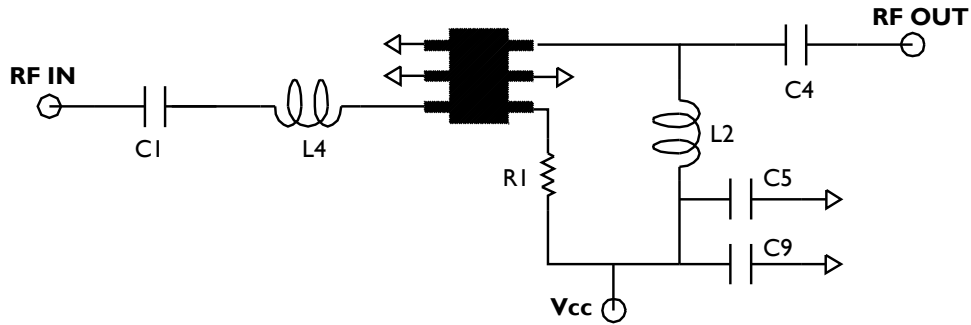

### Typical Performance: 3 V, 60 mA

Parameter	Units	TYP
Frequency	GHz	0.2
Gain	dB	23.0
Output IP3 <sup>15</sup>	dBm	33.5
Output P1dB	dBm	18.4
Input Return Loss	dB	-20.0
Output Return Loss	dB	-14.0
Noise Figure	dB	1.1

### Component Values

Ref Designator	Description
C1, C4	1 nF 0402 Capacitor
C5	10 nF 0402 Capacitor
C9	100 uF Tantalum Capacitor Size C
L2	150 nH 0603 Inductor
L4	24 nH 0402 Inductor
R1	Refer to Rbias Vs Idd plot
C2, C3, C6, C7, C8, L1, L3	DNP

15. Pout = 5 dBm, Tone Spacing = 1 MHz

### S-Parameters using 200 MHz evaluation board

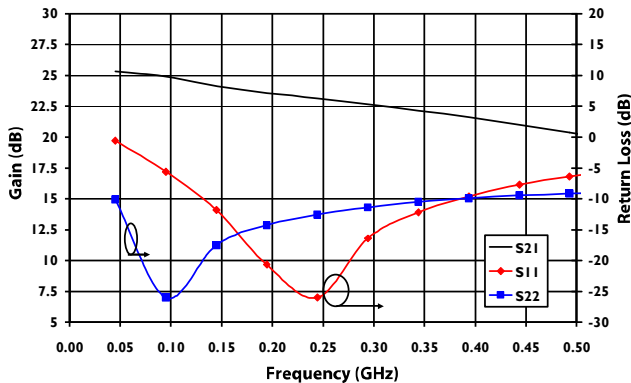

**Typical Noise Parameters: Vd = 3 V, 25 °C, Z<sub>0</sub> = 50 Ω**

**Id = 20 mA**

Freq (GHz)	NF <sub>min</sub> (dB)	Γ <sub>opt</sub> Mag.	Γ <sub>opt</sub> Ang.	R <sub>n/50</sub>	NF <sub>50Ω</sub> (dB)
0.80	0.80	0.08	136.5	0.08	0.81
0.90	0.77	0.11	133.6	0.07	0.78
1.00	0.78	0.12	132.5	0.08	0.78
1.50	0.81	0.17	-176.6	0.06	0.82
2.00	0.88	0.31	-156.0	0.06	0.89
2.50	0.96	0.32	-139.3	0.08	0.97
3.00	1.12	0.35	-108.1	0.13	1.13
3.50	1.26	0.40	-93.6	0.19	1.28
4.00	1.33	0.43	-64.1	0.36	1.36

**Id = 30 mA**

Freq (GHz)	NF <sub>min</sub> (dB)	Γ <sub>opt</sub> Mag.	Γ <sub>opt</sub> Ang.	R <sub>n/50</sub>	NF <sub>50Ω</sub> (dB)
0.80	0.77	0.07	153.4	0.07	0.77
0.90	0.73	0.10	145.8	0.07	0.74
1.00	0.75	0.12	145.3	0.07	0.75
1.50	0.76	0.16	-168.2	0.07	0.76
2.00	0.84	0.31	-155.7	0.06	0.85
2.50	0.92	0.32	-135.2	0.08	0.93
3.00	1.07	0.32	-104.9	0.14	1.08
3.50	1.20	0.37	-92.3	0.20	1.21
4.00	1.29	0.44	-61.6	0.33	1.31

**Id = 60 mA**

Freq (GHz)	NF <sub>min</sub> (dB)	Γ <sub>opt</sub> Mag.	Γ <sub>opt</sub> Ang.	R <sub>n/50</sub>	NF <sub>50Ω</sub> (dB)
0.80	0.76	0.07	160.5	0.07	0.76
0.90	0.73	0.09	150.5	0.07	0.73
1.00	0.74	0.12	154.2	0.07	0.74
1.50	0.75	0.17	-158.5	0.07	0.76
2.00	0.84	0.29	-151.8	0.06	0.85
2.50	0.93	0.30	-129.9	0.08	0.94
3.00	1.09	0.31	-99.9	0.14	1.10
3.50	1.21	0.43	-88.5	0.19	1.22
4.00	1.31	0.44	-60.0	0.32	1.33

**Typical Noise Parameters: Vd = 5 V, 25 °C, Z<sub>0</sub> = 50 Ω**

**Id = 20 mA**

Freq (GHz)	NF <sub>min</sub> (dB)	Γ <sub>opt</sub> Mag.	Γ <sub>opt</sub> Ang.	R <sub>n/50</sub>	NF <sub>50Ω</sub> (dB)
0.80	0.81	0.08	135.0	0.08	0.81
0.90	0.78	0.11	132.0	0.08	0.78
1.00	0.78	0.11	129.4	0.08	0.79
1.50	0.81	0.17	-175.2	0.07	0.81
2.00	0.89	0.30	-161.9	0.06	0.89
2.50	0.97	0.32	-139.7	0.08	0.97
3.00	1.14	0.34	-109.3	0.14	1.15
3.50	1.23	0.40	-92.9	0.21	1.25
4.00	1.33	0.44	-65.7	0.34	1.36

**Id = 30 mA**

Freq (GHz)	NF <sub>min</sub> (dB)	Γ <sub>opt</sub> Mag.	Γ <sub>opt</sub> Ang.	R <sub>n/50</sub>	NF <sub>50Ω</sub> (dB)
0.80	0.78	0.07	148.4	0.08	0.79
0.90	0.75	0.10	142.0	0.07	0.76
1.00	0.77	0.12	142.6	0.07	0.78
1.50	0.78	0.16	-165.7	0.07	0.79
2.00	0.87	0.30	-156.3	0.06	0.87
2.50	0.95	0.32	-135.2	0.08	0.96
3.00	1.10	0.32	-105.6	0.14	1.11
3.50	1.23	0.41	-89.1	0.20	1.25
4.00	1.31	0.47	-62.1	0.31	1.33

**Id = 60 mA**

Freq (GHz)	NF <sub>min</sub> (dB)	Γ <sub>opt</sub> Mag.	Γ <sub>opt</sub> Ang.	R <sub>n/50</sub>	NF <sub>50Ω</sub> (dB)
0.80	0.81	0.09	153.5	0.08	0.81
0.90	0.77	0.09	149.7	0.08	0.78
1.00	0.78	0.11	149.3	0.08	0.79
1.50	0.81	0.16	-160.0	0.07	0.81
2.00	0.90	0.30	-151.6	0.06	0.90
2.50	0.99	0.30	-130.2	0.09	1.00
3.00	1.16	0.31	-100.7	0.15	1.17
3.50	1.28	0.38	-88.1	0.23	1.30
4.00	1.37	0.43	-57.8	0.36	1.40

**Lead-Free SC70-6LD (SOT-363)<sup>†</sup>**

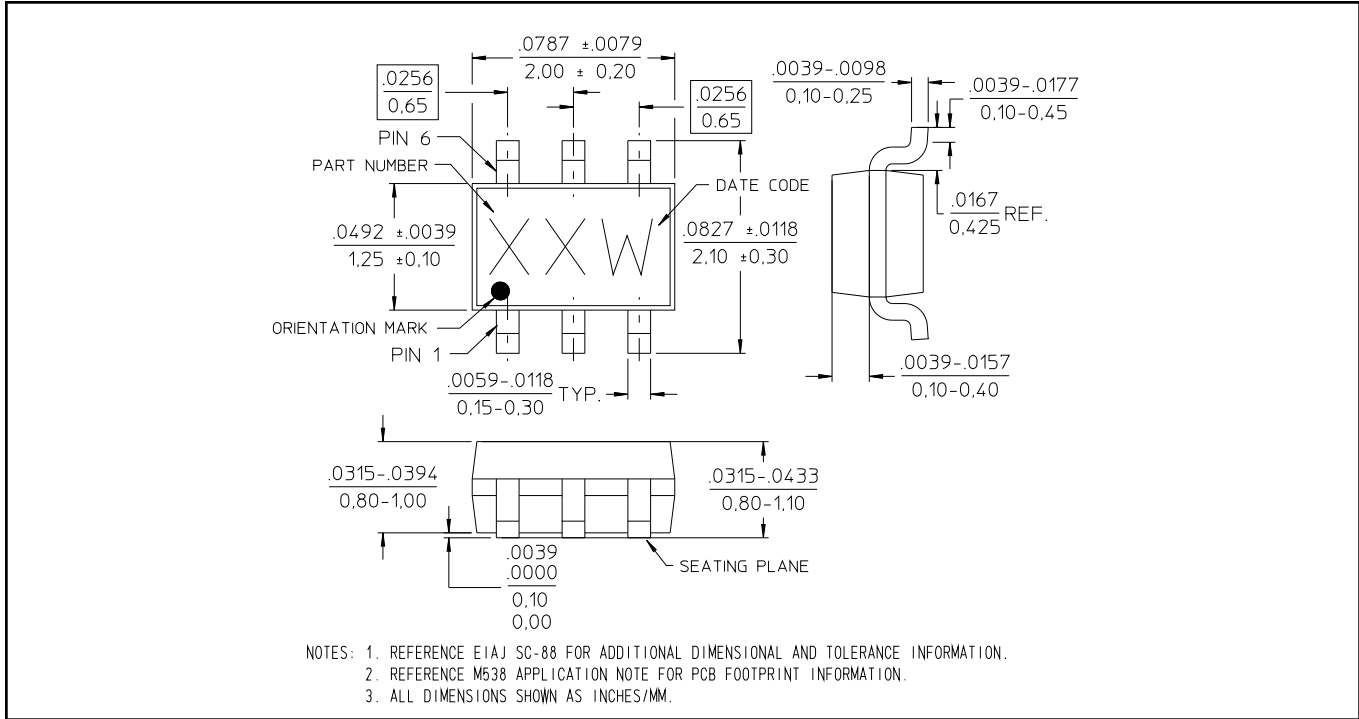

<sup>†</sup> Reference Application Note M538 for lead-free solder reflow recommendations.  
Meets JEDEC moisture sensitivity level 1 requirements.  
Plating is 100% matte tin over copper.

## Handling Procedures

Please observe the following precautions to avoid damage:

## Static Sensitivity

Gallium Arsenide Integrated Circuits are sensitive to electrostatic discharge (ESD) and can be damaged by static electricity. Proper ESD control techniques should be used when handling these class 2 devices.