

MITSUBISHI IGBT MODULES
CM100RL-12NF

HIGH POWER SWITCHING USE

CM100RL-12NF



- IC 100A
- VCES 600V
- Insulated Type
- 7-elements in a pack

APPLICATION

AC drive inverters & Servo controls, etc

OUTLINE DRAWING & CIRCUIT DIAGRAM

Dimensions in mm

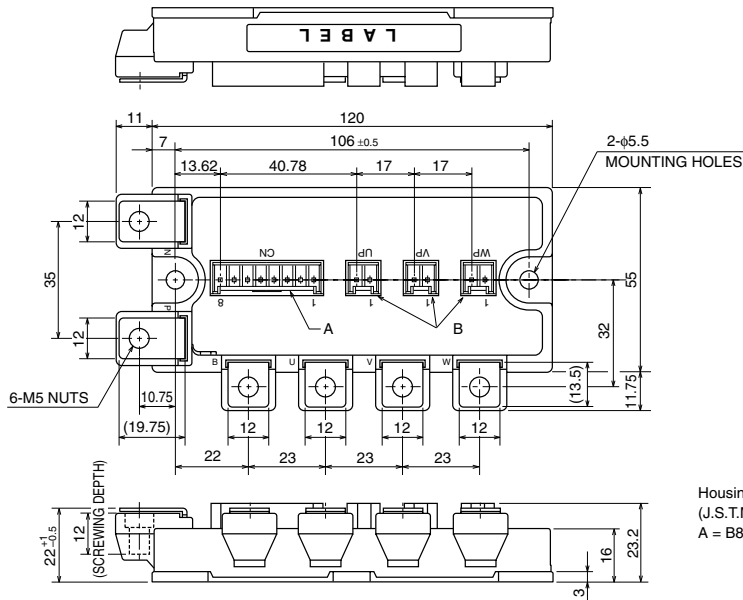

Housing Type of A and B
 (J.S.T.Mfg.Co.Ltd)
 A = B8P-VH-FB-B, B = B2P-VH-FB-B

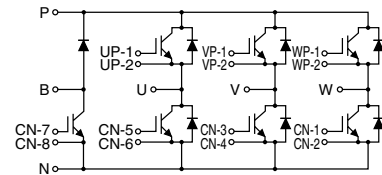

CIRCUIT DIAGRAM

CM100RL-12NF

HIGH POWER SWITCHING USE

ABSOLUTE MAXIMUM RATINGS (T_j = 25°C, unless otherwise specified)

INVERTER PART

Symbol	Parameter	Conditions	Ratings	Unit
V _{CES}	Collector-emitter voltage	G-E Short	600	V
V _{GES}	Gate-emitter voltage	C-E Short	±20	V
I _C	Collector current	DC, T _c = 99°C ^{*1}	100	A
I _{CM}		Pulse (Note 2)	200	A
I _E (Note 1)	Emitter current		100	A
I _{EM} (Note 1)		Pulse (Note 2)	200	A
P _C (Note 3)	Maximum collector dissipation	T _c = 25°C	540	W

BRAKE PART

Symbol	Parameter	Conditions	Ratings	Unit
V _{CES}	Collector-emitter voltage	G-E Short	600	V
V _{GES}	Gate-emitter voltage	C-E Short	±20	V
I _C	Collector current	DC, T _c = 107°C ^{*1}	50	A
I _{CM}		Pulse (Note 2)	100	A
P _C (Note 3)	Maximum collector dissipation	T _c = 25°C	320	W
V _{RRM}	Repetitive peak reverse voltage	Clamp diode part	600	V
I _{FM}	Forward current	Clamp diode part	50	A

(COMMON RATING)

Symbol	Parameter	Conditions	Ratings	Unit
T _j	Junction temperature		-40 ~ +150	°C
T _{stg}	Storage temperature		-40 ~ +125	°C
V _{iso}	Isolation voltage	Terminals to base plate, f = 60Hz, AC 1 minute	2500	V _{rms}
—	Torque strength	Main terminals M5 screw	2.5 ~ 3.5	N • m
—		Mounting M5 screw	2.5 ~ 3.5	N • m
—	Weight	Typical value	350	g

CM100RL-12NF

HIGH POWER SWITCHING USE

ELECTRICAL CHARACTERISTICS (T_J = 25°C, unless otherwise specified)

INVERTER PART

Symbol	Parameter	Test conditions	Limits			Unit	
			Min.	Typ.	Max.		
ICES	Collector cutoff current	VCE = VCES, VGE = 0V	—	—	1	mA	
VGE(th)	Gate-emitter threshold voltage	IC = 10mA, VCE = 10V	6	7	8	V	
IGES	Gate leakage current	±VGE = VGES, VCE = 0V	—	—	0.5	μA	
VCE(sat)	Collector-emitter saturation voltage	IC = 100A, VGE = 15V	T _J = 25°C	—	1.7	2.2	V
			T _J = 125°C	—	1.7	—	
Cies	Input capacitance	VCE = 10V VGE = 0V	—	—	15	nF	
Coes	Output capacitance		—	—	1.9	nF	
Cres	Reverse transfer capacitance		—	—	0.6	nF	
QG	Total gate charge	VCC = 300V, IC = 100A, VGE = 15V	—	400	—	nC	
td(on)	Turn-on delay time	VCC = 300V, IC = 100A VGE = ±15V RG = 6.3Ω, Inductive load IE = 100A	—	—	120	ns	
tr	Turn-on rise time		—	—	100	ns	
td(off)	Turn-off delay time		—	—	300	ns	
tf	Turn-off fall time		—	—	300	ns	
trr (Note 1)	Reverse recovery time		—	—	120	ns	
Qrr (Note 1)	Reverse recovery charge	—	2.1	—	μC		
VEC(Note 1)	Emitter-collector voltage	IE = 100A, VGE = 0V	—	—	2.8	V	
Rth(j-c)Q	Thermal resistance	IGBT part (1/6 module) ^{*1}	—	—	0.23	K/W	
Rth(j-c)R		FWDi part (1/6 module) ^{*1}	—	—	0.41	K/W	
Rth(c-f)	Contact thermal resistance	Case to heat sink, Thermal compound Applied (1/6 module) ^{*2}	—	0.085	—	K/W	
RG	External gate resistance		6.3	—	63	Ω	

BRAKE PART

Symbol	Parameter	Test conditions	Limits			Unit	
			Min.	Typ.	Max.		
ICES	Collector cutoff current	VCE = VCES, VGE = 0V	—	—	1	mA	
VGE(th)	Gate-emitter threshold voltage	IC = 5.0mA	6	7	8	V	
IGES	Gate leakage current	±VGE = VGES, VCE = 0V	—	—	0.5	μA	
VCE(sat)	Collector-emitter saturation voltage	IC = 50A, VGE = 15V	T _J = 25°C	—	1.7	2.2	V
			T _J = 125°C	—	1.7	—	
Cies	Input capacitance	VCE = 10V VGE = 0V	—	—	7.5	nF	
Coes	Output capacitance		—	—	1.0	nF	
Cres	Reverse transfer capacitance		—	—	0.3	nF	
QG	Total gate charge	VCC = 300V, IC = 50A, VGE = 15V	—	200	—	nC	
VFM	Forward voltage drop	IF = 50A	—	—	2.8	V	
Rth(j-c)Q	Thermal resistance	IGBT part ^{*1}	—	—	0.39	K/W	
Rth(j-c)R		Clamp diode part ^{*1}	—	—	0.70	K/W	
RG	External gate resistance		13	—	130	Ω	

*1 : Case temperature (T_c) measured point is just under the chips.

If you use this value, Rth(f-a) should be measured just under the chips.

*2 : Typical value is measured by using thermally conductive grease of λ = 0.9[W/(m • K)].

Note 1. IE, VEC, trr & Qrr represent characteristics of the anti-parallel, emitter-collector free-wheel diode (FWDi).

2. Pulse width and repetition rate should be such that the device junction temperature (T_J) does not exceed T_{Jmax} rating.

3. Junction temperature (T_J) should not increase beyond 150°C.

4. Pulse width and repetition rate should be such as to cause negligible temperature rise.

CM100RL-12NF

HIGH POWER SWITCHING USE

PERFORMANCE CURVES

OUTPUT CHARACTERISTICS (TYPICAL)

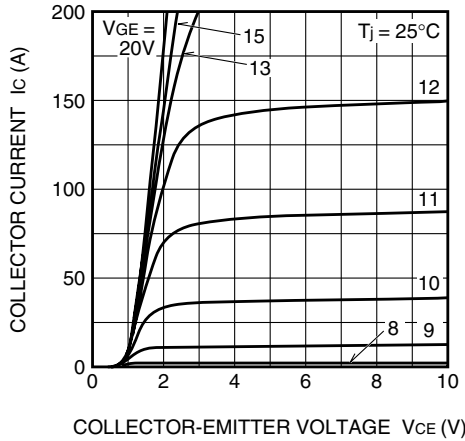

COLLECTOR-EMITTER SATURATION VOLTAGE CHARACTERISTICS (TYPICAL)

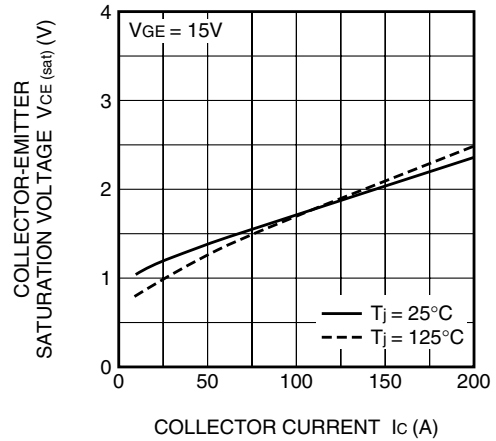

COLLECTOR-EMITTER SATURATION VOLTAGE CHARACTERISTICS (TYPICAL)

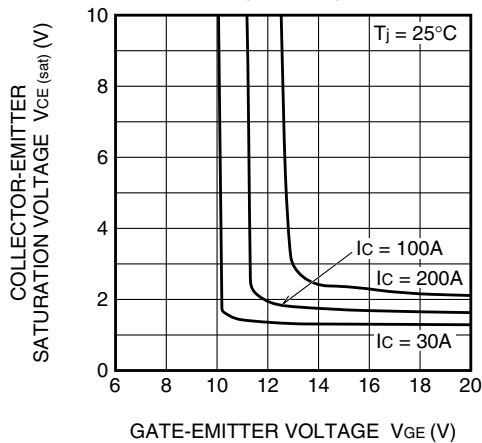

FREE-WHEEL DIODE FORWARD CHARACTERISTICS (TYPICAL)

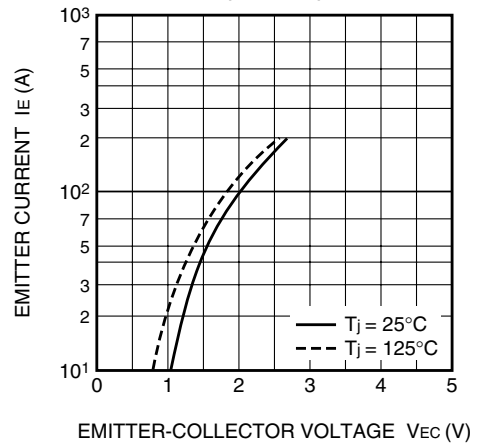

CAPACITANCE-VCE CHARACTERISTICS (TYPICAL)

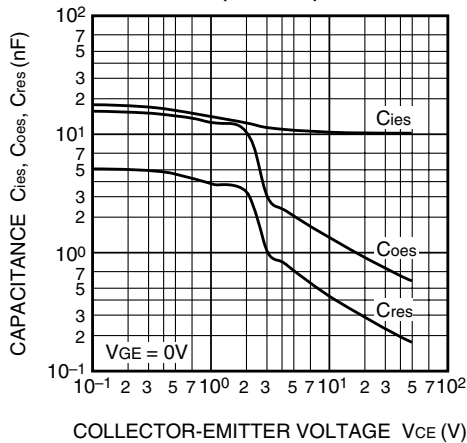

HALF-BRIDGE SWITCHING CHARACTERISTICS (TYPICAL)

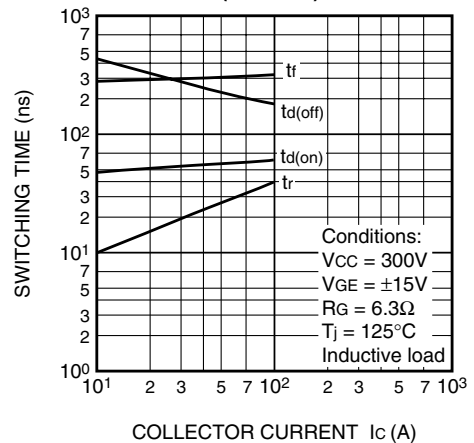

CM100RL-12NF

HIGH POWER SWITCHING USE

REVERSE RECOVERY CHARACTERISTICS OF FREE-WHEEL DIODE (TYPICAL)

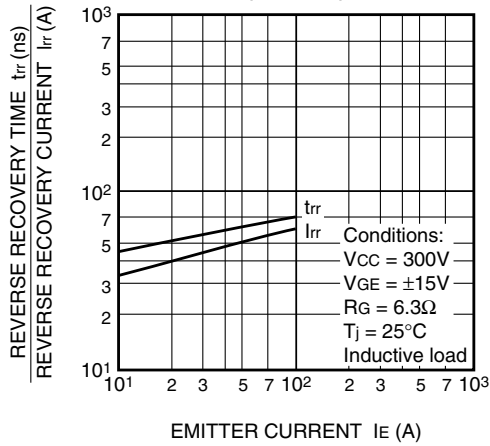

TRANSIENT THERMAL IMPEDANCE CHARACTERISTICS (IGBT part & FWDi part)

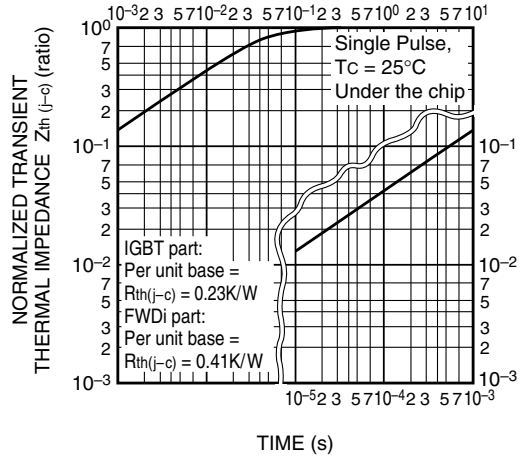

SWITCHING LOSS vs. COLLECTOR CURRENT (TYPICAL)

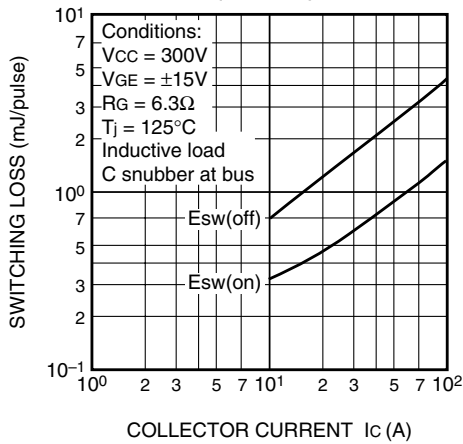

SWITCHING LOSS vs. GATE RESISTANCE (TYPICAL)

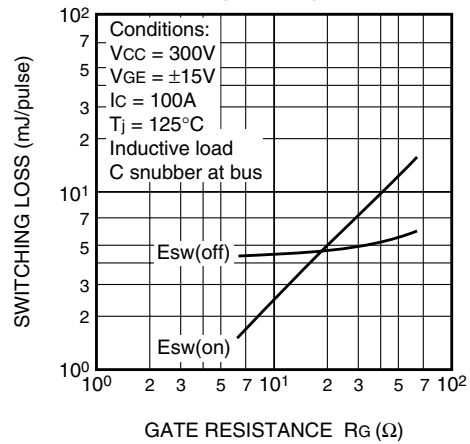

RECOVERY LOSS vs. IE (TYPICAL)

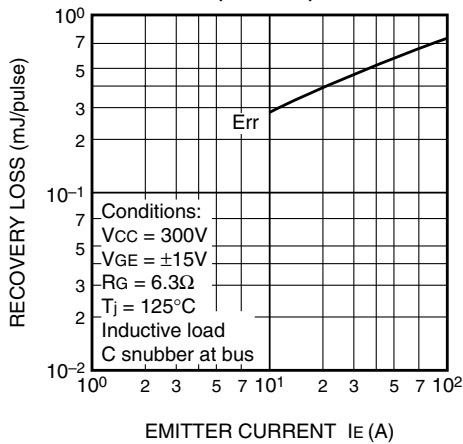

RECOVERY LOSS vs. GATE RESISTANCE (TYPICAL)

