

MITSUBISHI IGBT MODULES
CM100TU-24F

HIGH POWER SWITCHING USE

CM100TU-24F



- IC 100A
- VCES 1200V
- Insulated Type
- 6-elements in a pack

APPLICATION

General purpose inverters & Servo controls, etc

OUTLINE DRAWING & CIRCUIT DIAGRAM

Dimensions in mm

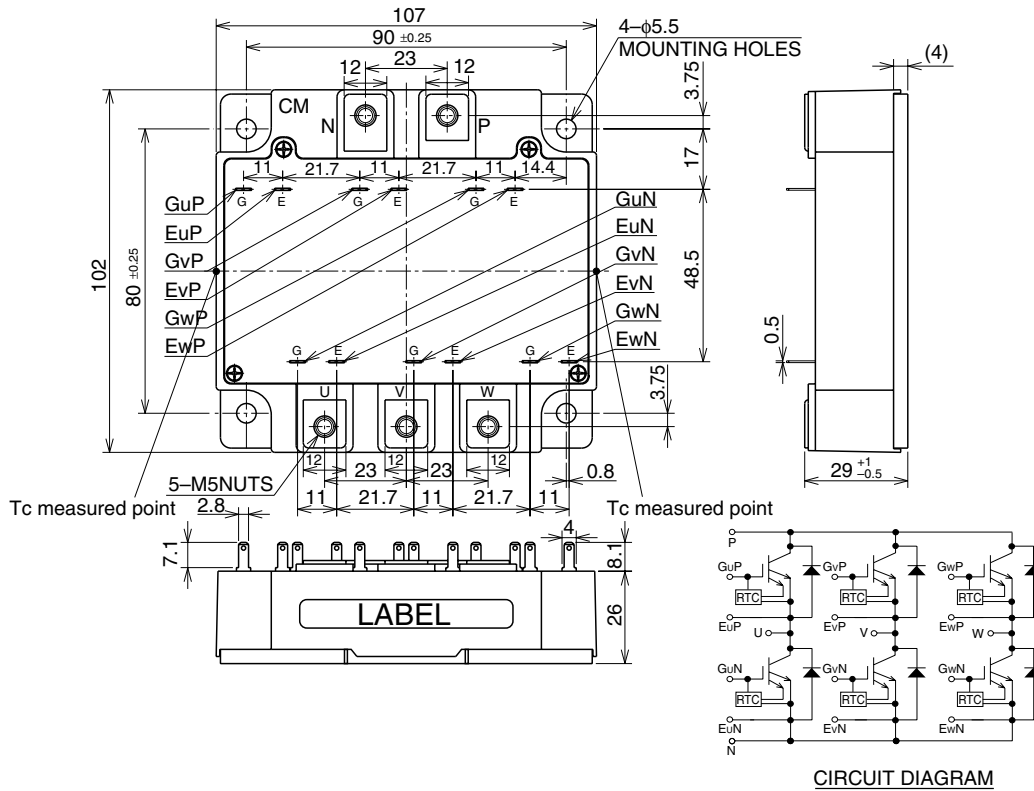

CM100TU-24F

HIGH POWER SWITCHING USE

MAXIMUM RATINGS (T_j = 25°C, unless otherwise specified)

Symbol	Parameter	Conditions	Ratings	Unit
V _{CES}	Collector-emitter voltage	G-E Short	1200	V
V _{GES}	Gate-emitter voltage	C-E Short	±20	V
I _C	Collector current	T _c = 25°C	100	A
I _{CM}		Pulse (Note 2)	200	
I _E (Note 1)	Emitter current	T _c = 25°C	100	A
I _{EM} (Note 1)		Pulse (Note 2)	200	
P _C (Note 3)	Maximum collector dissipation	T _c = 25°C	500	W
T _j	Junction temperature		-40 ~ +150	°C
T _{stg}	Storage temperature		-40 ~ +125	°C
V _{iso}	Isolation voltage	Terminals to base plate, f = 60Hz, AC 1 minute	2500	V _{rms}
—	Torque strength	Main terminals M5 screw	2.5 ~ 3.5	N • m
		Mounting M5 screw	2.5 ~ 3.5	N • m
—	Weight	Typical value	680	g

ELECTRICAL CHARACTERISTICS (T_j = 25°C, unless otherwise specified)

Symbol	Parameter	Test conditions	Limits			Unit								
			Min.	Typ.	Max.									
I _{CES}	Collector cutoff current	V _{CE} = V _{CES} , V _{GE} = 0V	—	—	1	mA								
V _{GE(th)}	Gate-emitter threshold voltage	I _C = 10mA, V _{CE} = 10V	5	6	7	V								
I _{GES}	Gate leakage current	±V _{GE} = V _{GES} , V _{CE} = 0V	—	—	20	μA								
V _{CE(sat)}	Collector-emitter saturation voltage	I _C = 100A, V _{GE} = 15V	<table border="1"> <tr> <td>T_j = 25°C</td> <td>—</td> <td>1.8</td> <td>2.4</td> </tr> <tr> <td>T_j = 125°C</td> <td>—</td> <td>1.9</td> <td>—</td> </tr> </table>			T _j = 25°C	—	1.8	2.4	T _j = 125°C	—	1.9	—	V
T _j = 25°C	—	1.8	2.4											
T _j = 125°C	—	1.9	—											
C _{ies}	Input capacitance	V _{CE} = 10V V _{GE} = 0V	—	—	39	nF								
C _{oes}	Output capacitance		—	—	1.7									
C _{res}	Reverse transfer capacitance		—	—	1.0									
Q _G	Total gate charge	V _{CC} = 600V, I _C = 100A, V _{GE} = 15V	—	1100	—	nC								
t _{d(on)}	Turn-on delay time	V _{CC} = 600V, I _C = 100A V _{GE} = ±15V R _G = 3.1Ω, Inductive load I _E = 100A	—	—	100	ns								
t _r	Turn-on rise time		—	—	50									
t _{d(off)}	Turn-off delay time		—	—	400									
t _f	Turn-off fall time		—	—	300									
t _{rr} (Note 1)	Reverse recovery time		—	—	150									
Q _{rr} (Note 1)	Reverse recovery charge	—	4.1	—	μC									
V _{EC} (Note 1)	Emitter-collector voltage	I _E = 100A, V _{GE} = 0V	—	—	3.2	V								
R _{th(j-c)Q}	Thermal resistance*1	IGBT part (1/6 module)	—	—	0.25	K/W								
R _{th(j-c)R}		FWDi part (1/6 module)	—	—	0.35									
R _{th(c-f)}	Contact thermal resistance	Case to heat sink, Thermal compound applied*2 (1/6 module)	—	0.09	—									
R _{th(j-c)Q}	Thermal resistance	Case temperature measured point is just under the chips	—	—	0.18*3									
R _G	External gate resistance		3.1	—	31	Ω								

Note 1. I_E, V_{EC}, t_{rr}, Q_{rr} & die/dt represent characteristics of the anti-parallel, emitter-collector free-wheel diode (FWDi).
 2. Pulse width and repetition rate should be such that the device junction temperature (T_j) does not exceed T_{jmax} rating.
 3. Junction temperature (T_j) should not increase beyond 150°C.
 4. Pulse width and repetition rate should be such as to cause negligible temperature rise.
 *1 : Case temperature (T_c) measured point is indicated in OUTLINE DRAWING.
 *2 : Typical value is measured by using thermally conductive grease of λ = 0.9[W/(m • K)].
 *3 : If you use this value, R_{th(f-a)} should be measured just under the chips.

PERFORMANCE CURVES

OUTPUT CHARACTERISTICS (TYPICAL)

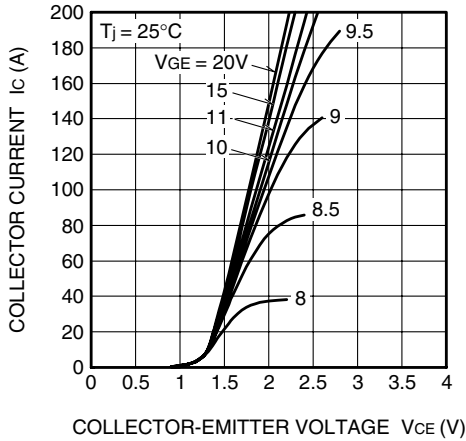

COLLECTOR-EMITTER SATURATION VOLTAGE CHARACTERISTICS (TYPICAL)

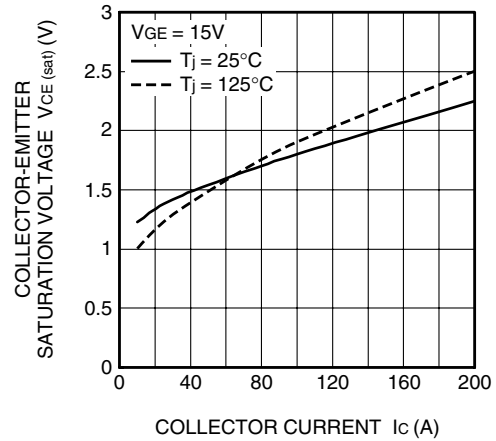

COLLECTOR-EMITTER SATURATION VOLTAGE CHARACTERISTICS (TYPICAL)

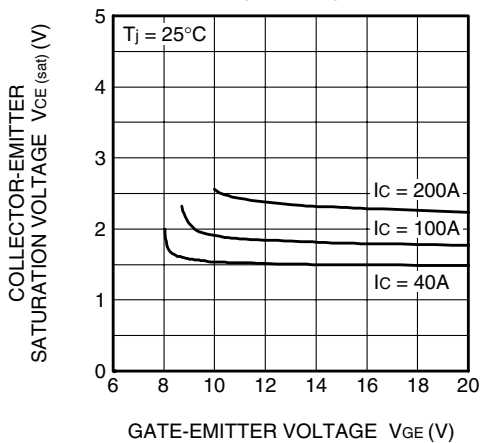

FREE-WHEEL DIODE FORWARD CHARACTERISTICS (TYPICAL)

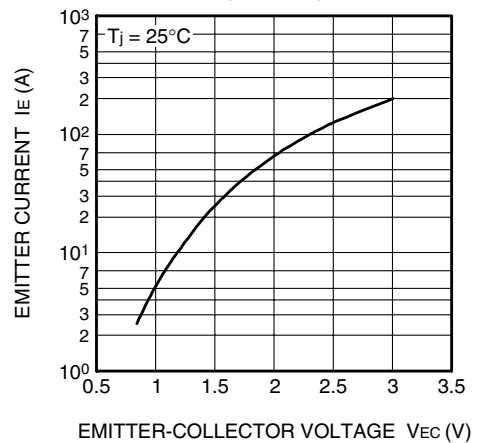

CAPACITANCE-VCE CHARACTERISTICS (TYPICAL)

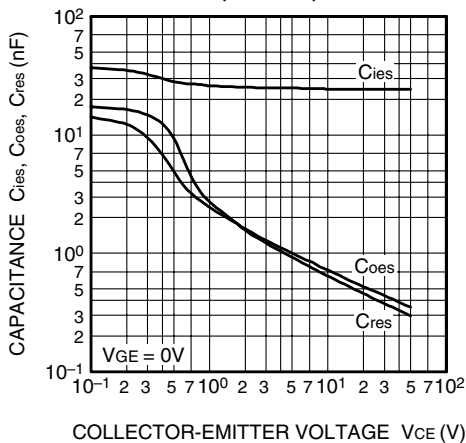

HALF-BRIDGE SWITCHING CHARACTERISTICS (TYPICAL)

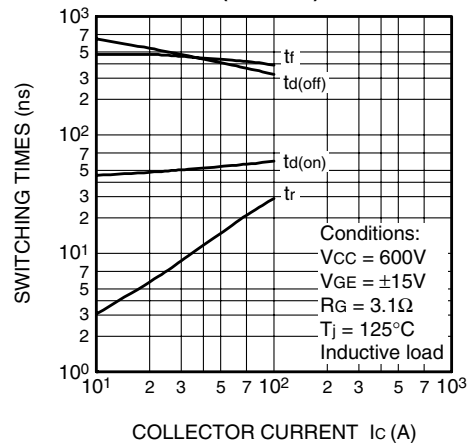

REVERSE RECOVERY CHARACTERISTICS OF FREE-WHEEL DIODE (TYPICAL)

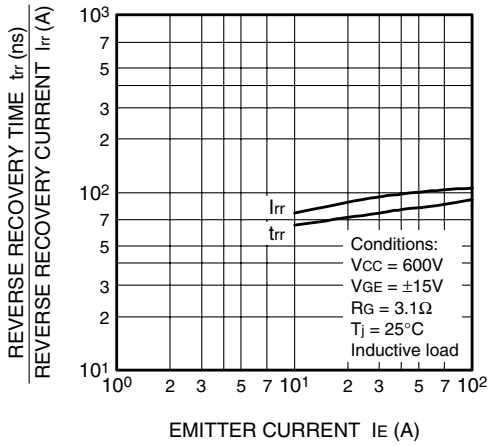

TRANSIENT THERMAL IMPEDANCE CHARACTERISTICS (IGBT part & FWDi part)

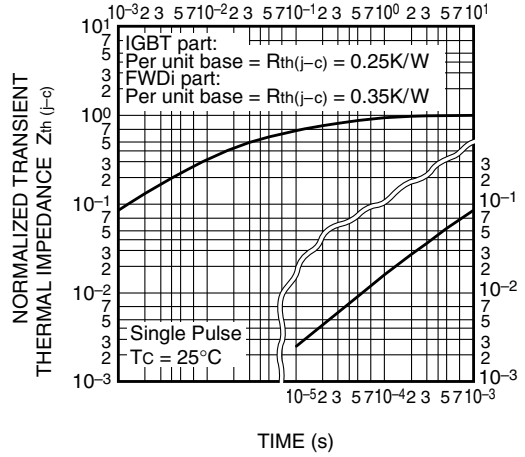

GATE CHARGE CHARACTERISTICS (TYPICAL)

