

MITSUBISHI IGBT MODULES  
**CM150DU-24NFH**

HIGH POWER SWITCHING USE

**CM150DU-24NFH**



- IC ..... 150A
- VCES ..... 1200V
- Insulated Type
- 2-elements in a pack

**APPLICATION**

High frequency switching use (30kHz to 60kHz).  
 Gradient amplifier, Induction heating, power supply, etc.

**OUTLINE DRAWING & CIRCUIT DIAGRAM**

Dimensions in mm

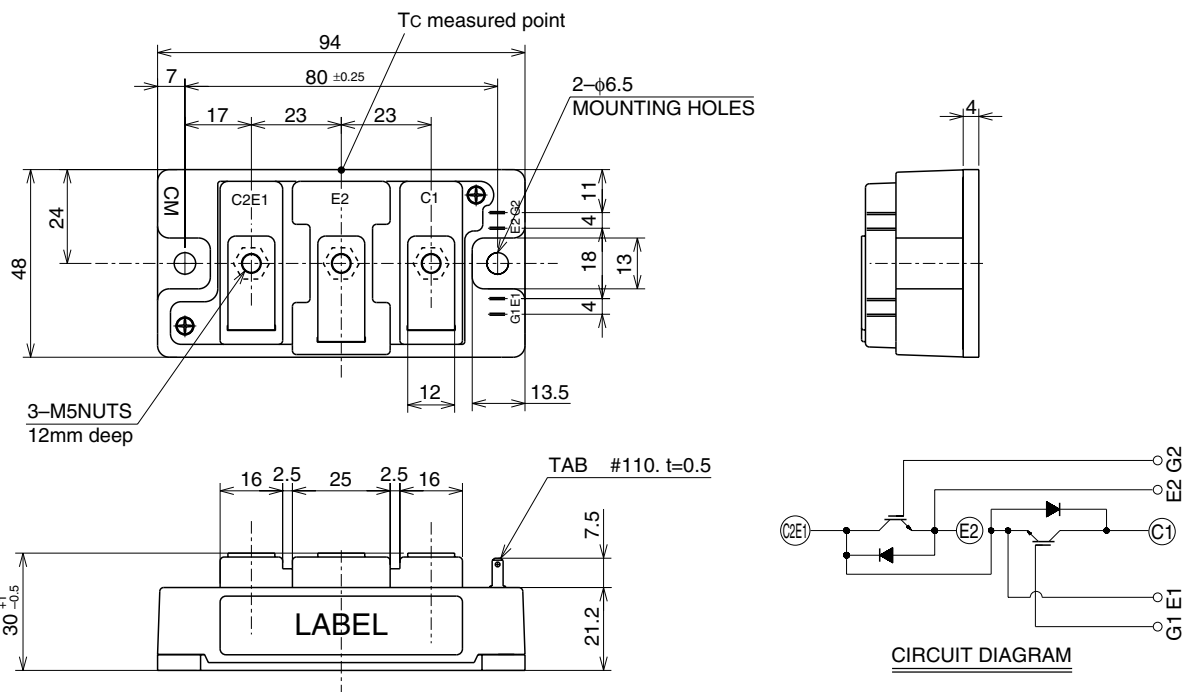

CM150DU-24NFH

HIGH POWER SWITCHING USE

**MAXIMUM RATINGS** (T<sub>j</sub> = 25°C, unless otherwise specified)

Symbol	Parameter	Conditions	Ratings	Unit
V <sub>CE</sub> S	Collector-emitter voltage	G-E Short	1200	V
V <sub>GE</sub> S	Gate-emitter voltage	C-E Short	±20	V
I <sub>C</sub>	Collector current	Operation (Note 2)	150	A
I <sub>CM</sub>		Pulse (Note 2)	300	A
I <sub>E</sub> (Note 1)	Emitter current	Operation (Note 2)	150	A
I <sub>EM</sub> (Note 1)		Pulse (Note 2)	300	A
P <sub>C</sub> (Note 3)	Maximum collector dissipation	T <sub>c</sub> = 25°C	650	W
P <sub>C</sub> ' (Note 3)	Maximum collector dissipation	T <sub>c</sub> ' = 25°C <sup>4</sup>	960	W
T <sub>j</sub>	Junction temperature		-40 ~ +150	°C
T <sub>stg</sub>	Storage temperature		-40 ~ +125	°C
V <sub>iso</sub>	Isolation voltage	Terminals to base plate, f = 60Hz, AC 1 minute	2500	V <sub>rms</sub>
—	Mounting torque	Main terminals M5 screw	2.5 ~ 3.5	N • m
—		Mounting M6 screw	3.5 ~ 4.5	N • m
—	Weight	Typical value	310	g

**ELECTRICAL CHARACTERISTICS** (T<sub>j</sub> = 25°C, unless otherwise specified)

Symbol	Parameter	Test conditions	Limits			Unit	
			Min.	Typ.	Max.		
I <sub>CE</sub> S	Collector cutoff current	V <sub>CE</sub> = V <sub>CE</sub> S, V <sub>GE</sub> = 0V	—	—	1	mA	
V <sub>GE(th)</sub>	Gate-emitter threshold voltage	I <sub>C</sub> = 15mA, V <sub>CE</sub> = 10V	4.5	6	7.5	V	
I <sub>GES</sub>	Gate leakage current	±V <sub>GE</sub> = V <sub>GES</sub> , V <sub>CE</sub> = 0V	—	—	0.5	μA	
V <sub>CE(sat)</sub>	Collector-emitter saturation voltage	I <sub>C</sub> = 150A, V <sub>GE</sub> = 15V	T <sub>j</sub> = 25°C	—	5.0	6.5	V
			T <sub>j</sub> = 125°C	—	5.0	—	
C <sub>ies</sub>	Input capacitance	V <sub>CE</sub> = 10V V <sub>GE</sub> = 0V	—	—	24	nF	
C <sub>oes</sub>	Output capacitance		—	—	2.0	nF	
C <sub>res</sub>	Reverse transfer capacitance		—	—	0.45	nF	
Q <sub>G</sub>	Total gate charge	V <sub>CC</sub> = 600V, I <sub>C</sub> = 150A, V <sub>GE</sub> = 15V	—	680	—	nC	
t <sub>d(on)</sub>	Turn-on delay time	V <sub>CC</sub> = 600V, I <sub>C</sub> = 150A V <sub>GE</sub> = ±15V R <sub>G</sub> = 2.1Ω, Inductive load	—	—	150	ns	
t <sub>r</sub>	Turn-on rise time		—	—	80	ns	
t <sub>d(off)</sub>	Turn-off delay time		—	—	400	ns	
t <sub>f</sub>	Turn-off fall time		—	—	150	ns	
t <sub>rr</sub> (Note 1)	Reverse recovery time		I <sub>E</sub> = 150A	—	—	150	ns
Q <sub>rr</sub> (Note 1)	Reverse recovery charge			—	7.5	—	μC
V <sub>EC</sub> (Note 1)	Emitter-collector voltage	I <sub>E</sub> = 150A, V <sub>GE</sub> = 0V	—	—	3.5	V	
R <sub>th(j-c)Q</sub>	Thermal resistance*1	IGBT part (1/2 module)	—	—	0.19	K/W	
R <sub>th(j-c)R</sub>		FWDi part (1/2 module)	—	—	0.35	K/W	
R <sub>th(c-f)</sub>	Contact thermal resistance	Case to heat sink, Thermal compound Applied*2 (1/2 module)	—	0.07	—	K/W	
R <sub>th(j-c)Q</sub>	Thermal resistance*4	IGBT part (1/2 module)	—	—	0.13*3	K/W	
R <sub>th(j-c)R</sub>		FWDi part (1/2 module)	—	—	0.21*3	K/W	
R <sub>G</sub>	External gate resistance		2.1	—	21	Ω	

\*1 : Case temperature (T<sub>c</sub>) measured point is shown in page OUTLINE DRAWING.

\*2 : Typical value is measured by using thermally conductive grease of λ = 0.9[W/(m • K)].

\*3 : If you use this value, R<sub>th(f-a)</sub> should be measured just under the chips.

\*4 : Case temperature (T<sub>c</sub>) measured point is just under the chips.

Note 1. I<sub>E</sub>, V<sub>EC</sub>, t<sub>rr</sub> & Q<sub>rr</sub> represent characteristics of the anti-parallel, emitter-collector free-wheel diode (FWDi).

2. Pulse width and repetition rate should be such that the device junction temperature (T<sub>j</sub>) does not exceed T<sub>jmax</sub> rating.

3. Junction temperature (T<sub>j</sub>) should not increase beyond 150°C.

4. No short circuit capability is designed.

PERFORMANCE CURVES

OUTPUT CHARACTERISTICS (TYPICAL)

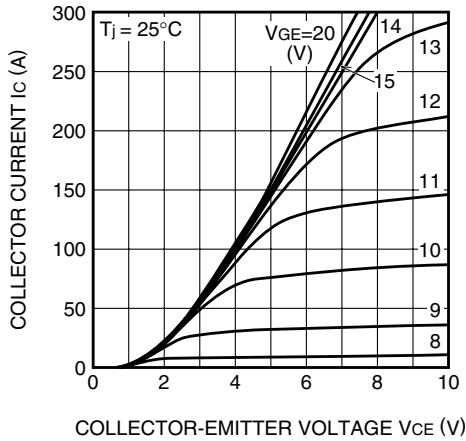

TRANSFER CHARACTERISTICS (TYPICAL)

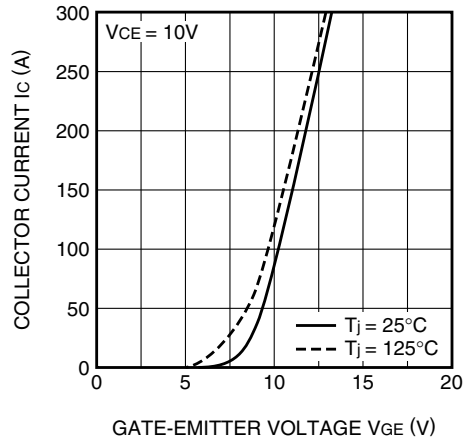

COLLECTOR-EMITTER SATURATION VOLTAGE CHARACTERISTICS (TYPICAL)

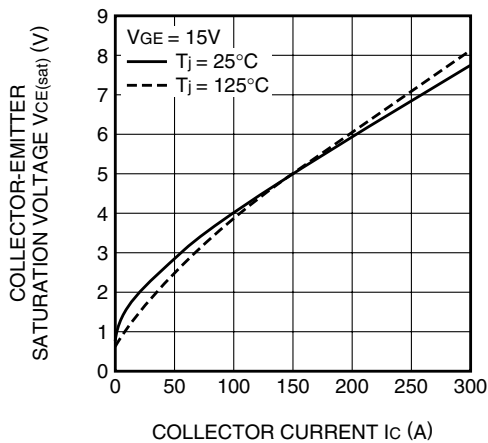

COLLECTOR-EMITTER SATURATION VOLTAGE CHARACTERISTICS (TYPICAL)

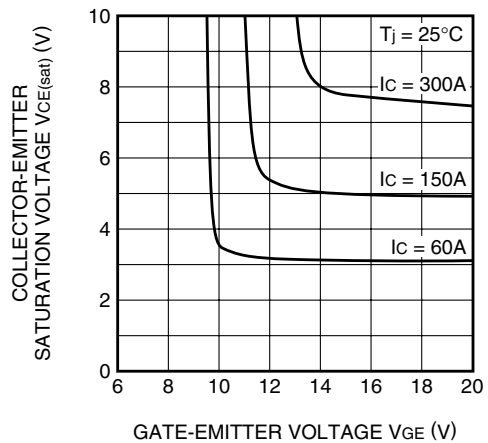

FREE-WHEEL DIODE FORWARD CHARACTERISTICS (TYPICAL)

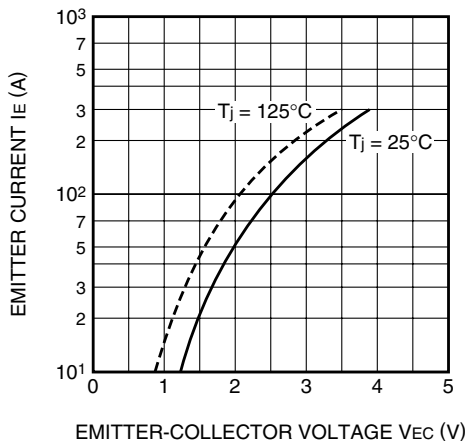

CAPACITANCE CHARACTERISTICS (TYPICAL)

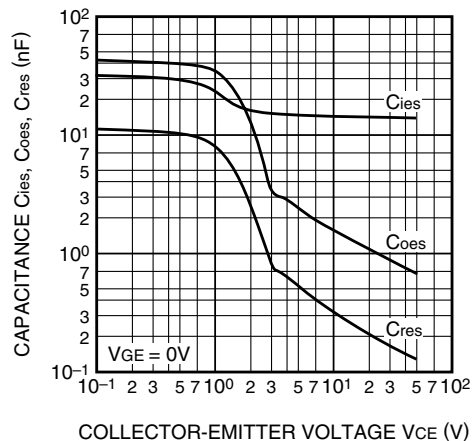

**HALF-BRIDGE SWITCHING TIME CHARACTERISTICS (TYPICAL)**

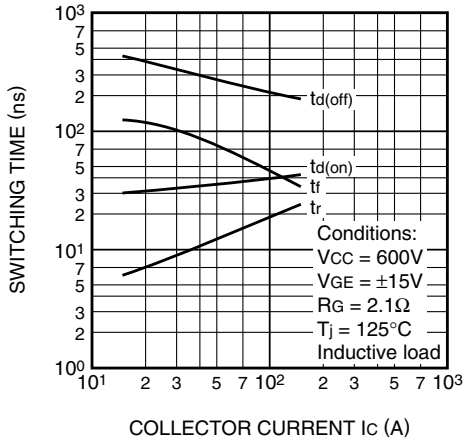

**REVERSE RECOVERY CHARACTERISTICS OF FREE-WHEEL DIODE (TYPICAL)**

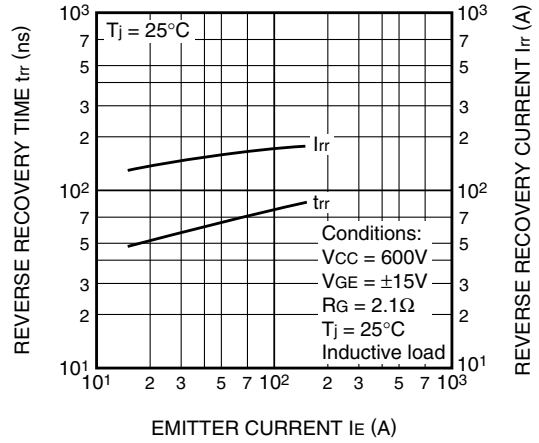

**TRANSIENT THERMAL IMPEDANCE CHARACTERISTICS (IGBT part)**

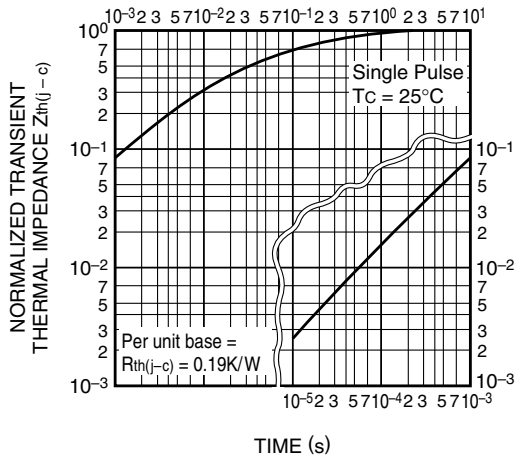

**TRANSIENT THERMAL IMPEDANCE CHARACTERISTICS (FWDi part)**

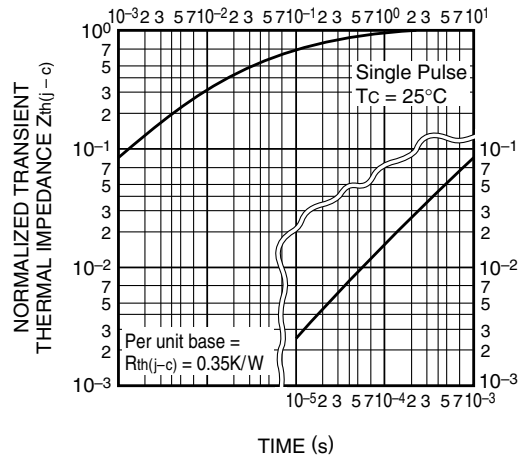

**GATE CHARGE CHARACTERISTICS (TYPICAL)**

