

MITSUBISHI IGBT MODULES
CM400HU-24F

HIGH POWER SWITCHING USE

CM400HU-24F



- IC 400A
- VCES 1200V
- Insulated Type
- 1-elements in a pack

APPLICATION

General purpose inverters & Servo controls, etc

OUTLINE DRAWING & CIRCUIT DIAGRAM

Dimensions in mm

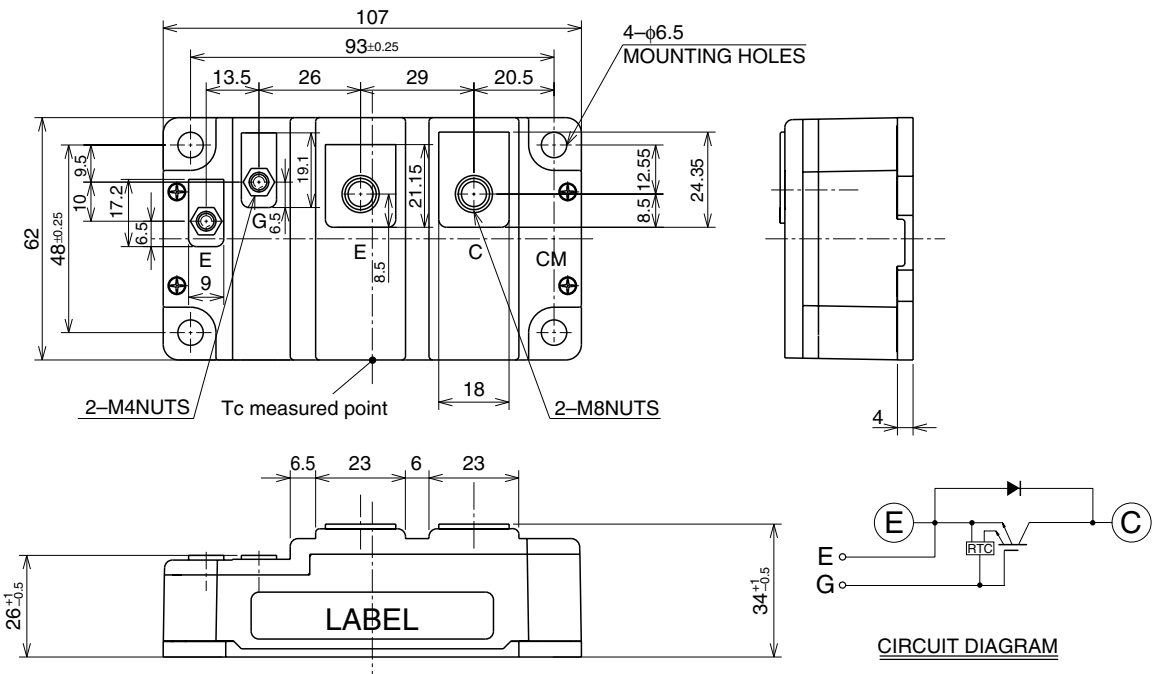

CM400HU-24F

HIGH POWER SWITCHING USE

MAXIMUM RATINGS (Tj = 25°C, unless otherwise specified)

Symbol	Parameter	Conditions	Ratings	Unit
V _{CE} S	Collector-emitter voltage	G-E Short	1200	V
V _{GE} S	Gate-emitter voltage	C-E Short	±20	V
I _C	Collector current	T _C = 25°C	400	A
I _{CM}		Pulse (Note 2)	800	
I _E (Note 1)	Emitter current	T _C = 25°C	400	A
I _{EM} (Note 1)		Pulse (Note 2)	800	
P _C (Note 3)	Maximum collector dissipation	T _C = 25°C	1600	W
T _j	Junction temperature		-40 ~ +150	°C
T _{stg}	Storage temperature		-40 ~ +125	°C
V _{iso}	Isolation voltage	Terminals to base plate, f = 60Hz, AC 1 minute	2500	V _{rms}
—	Torque strength	Main terminals M8 screw	8.8 ~ 10.8	N • m
		Mounting M6 screw	3.5 ~ 4.5	N • m
		G(E) Terminal M4 screw	1.3 ~ 1.7	N • m
—	Weight	Typical value	450	g

ELECTRICAL CHARACTERISTICS (Tj = 25°C, unless otherwise specified)

Symbol	Parameter	Test conditions	Limits			Unit	
			Min.	Typ.	Max.		
I _{CE} S	Collector cutoff current	V _{CE} = V _{CE} S, V _{GE} = 0V	—	—	2	mA	
V _{GE(th)}	Gate-emitter threshold voltage	I _C = 40mA, V _{CE} = 10V	5	6	7	V	
I _{GES}	Gate leakage current	±V _{GE} = V _{GES} , V _{CE} = 0V	—	—	80	µA	
V _{CE(sat)}	Collector-emitter saturation voltage	I _C = 400A, V _{GE} = 15V	—	T _j = 25°C 1.8	2.4	V	
		T _j = 125°C 1.9		—			
C _{ies}	Input capacitance	V _{CE} = 10V V _{GE} = 0V	—	—	160	nF	
C _{oes}	Output capacitance		—	—	6.8		
C _{res}	Reverse transfer capacitance		—	—	4.0		
Q _G	Total gate charge	V _{CC} = 600V, I _C = 400A, V _{GE} = 15V	—	4400	—	nC	
t _{d(on)}	Turn-on delay time	V _{CC} = 600V, I _C = 400A V _{GE} = ±15V R _G = 0.78Ω, Inductive load	—	—	300	ns	
t _r	Turn-on rise time		—	—	100		
t _{d(off)}	Turn-off delay time		—	—	600		
t _f	Turn-off fall time		—	—	300		
t _{rr} (Note 1)	Reverse recovery time		I _E = 400A	—	—		350
Q _{rr} (Note 1)	Reverse recovery charge			—	23.6		—
V _{EC} (Note 1)	Emitter-collector voltage	I _E = 400A, V _{GE} = 0V	—	—	3.2	V	
R _{th(j-c)Q}	Thermal resistance*1	IGBT part	—	—	0.078	K/W	
R _{th(j-c)R}		FWDi part	—	—	0.09		
R _{th(c-f)}	Contact thermal resistance	Case to heat sink, Thermal compound applied*2	—	0.02	—		
R _{th(j-c)Q}	Thermal resistance	Case temperature measured point is just under the chips	—	—	0.045*3		
R _G	External gate resistance		0.78	—	7.8	Ω	

Note 1. I_E, V_{EC}, t_{rr}, Q_{rr} & die/dt represent characteristics of the anti-parallel, emitter-collector free-wheel diode (FWDi).
 2. Pulse width and repetition rate should be such that the device junction temperature (T_j) does not exceed T_{jmax} rating.
 3. Junction temperature (T_j) should not increase beyond 150°C.
 4. Pulse width and repetition rate should be such as to cause negligible temperature rise.
 *1 : Case temperature (T_c) measured point is indicated in OUTLINE DRAWING.
 *2 : Typical value is measured by using thermally conductive grease of λ = 0.9[W/(m • K)].
 *3 : If you use this value, R_{th(f-a)} should be measured just under the chips.

PERFORMANCE CURVES

OUTPUT CHARACTERISTICS (TYPICAL)

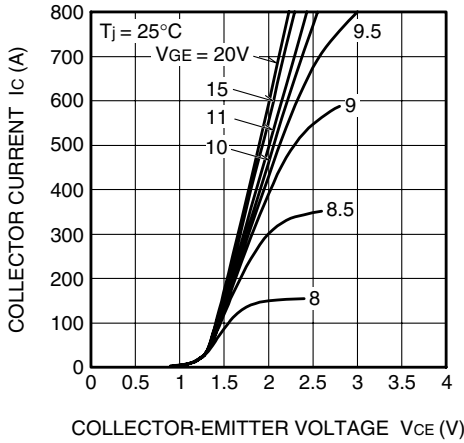

COLLECTOR-EMITTER SATURATION VOLTAGE CHARACTERISTICS (TYPICAL)

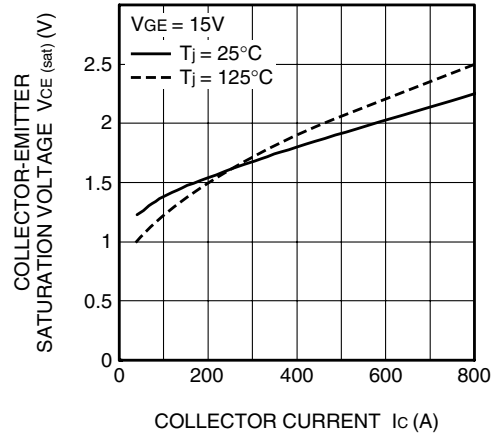

COLLECTOR-EMITTER SATURATION VOLTAGE CHARACTERISTICS (TYPICAL)

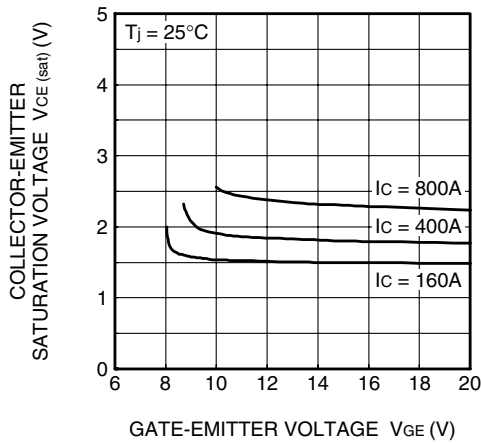

FREE-WHEEL DIODE FORWARD CHARACTERISTICS (TYPICAL)

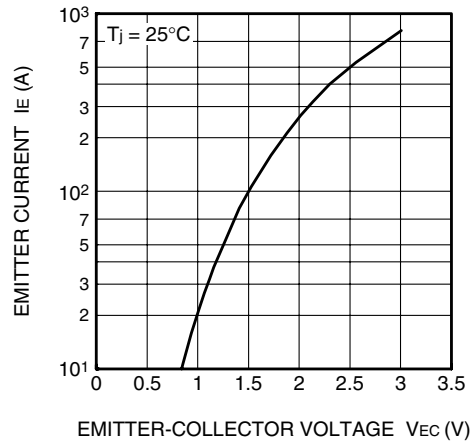

CAPACITANCE-Vce CHARACTERISTICS (TYPICAL)

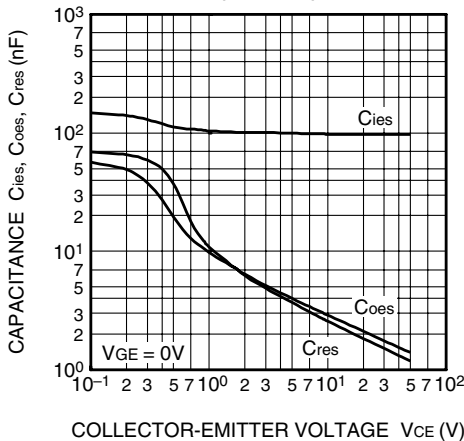

HALF-BRIDGE SWITCHING CHARACTERISTICS (TYPICAL)

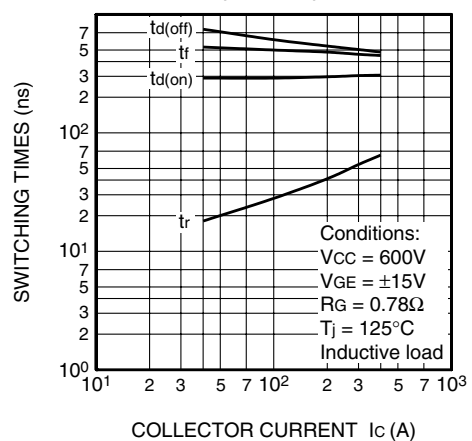

REVERSE RECOVERY CHARACTERISTICS OF FREE-WHEEL DIODE (TYPICAL)

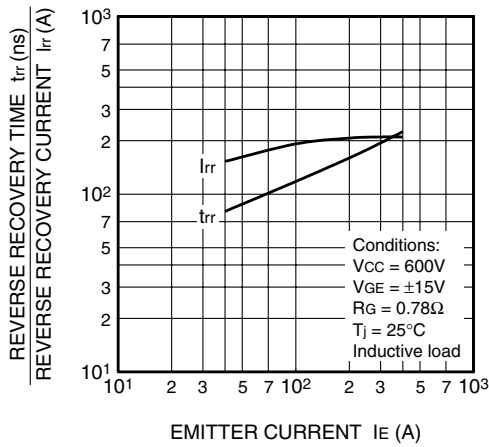

TRANSIENT THERMAL IMPEDANCE CHARACTERISTICS (IGBT part & FWDi part)

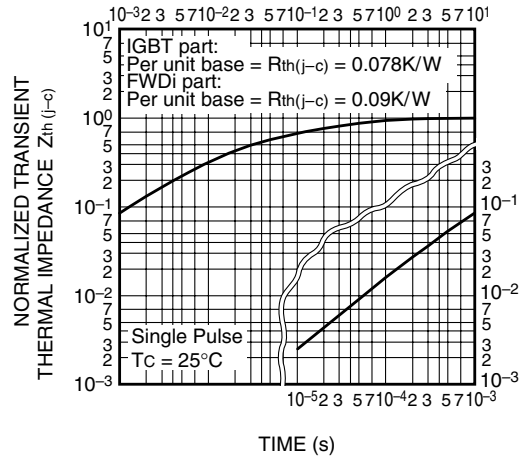

GATE CHARGE CHARACTERISTICS (TYPICAL)

