

MITSUBISHI IGBT MODULES  
**CM400HX-24A**

HIGH POWER SWITCHING USE

**CM400HX-24A**



- IC ..... 400A
- VCES ..... 1200V
- Single
- Flatbase Type / Insulated Package / Copper (non-plating) base plate
- RoHS Directive compliant

**APPLICATION**

General purpose Inverters, Servo Amplifiers, Power supply, etc.

**OUTLINE DRAWING & CIRCUIT DIAGRAM**

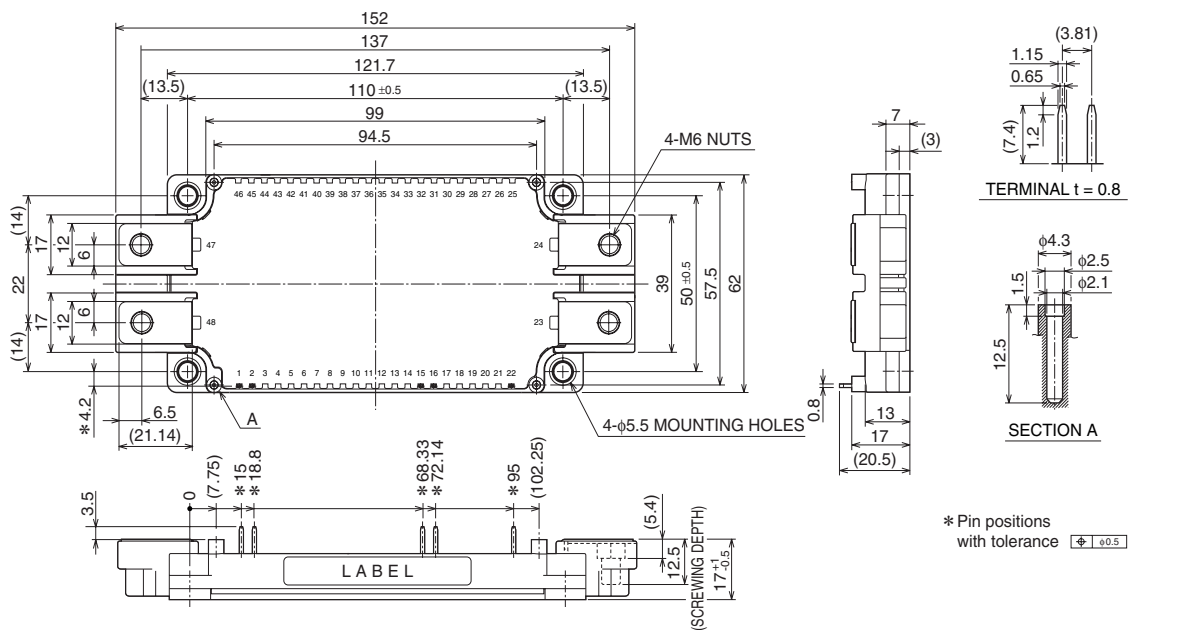

Tolerance otherwise specified

Division of Dimension	Tolerance
0.5 to 3	±0.2
over 3 to 6	±0.3
over 6 to 30	±0.5
over 30 to 120	±0.8
over 120 to 400	±1.2

**ABSOLUTE MAXIMUM RATINGS** (T<sub>j</sub> = 25°C, unless otherwise specified)

**INVERTER PART**

Symbol	Parameter	Conditions	Rating	Unit
V <sub>CES</sub>	Collector-emitter voltage	G-E Short	1200	V
V <sub>GES</sub>	Gate-emitter voltage	C-E Short	±20	
I <sub>C</sub>	Collector current	DC, T <sub>c</sub> = 88°C (Note. 1)	400	A
I <sub>CRM</sub>		Pulse (Note. 4)	800	
P <sub>C</sub>	Maximum collector dissipation	T <sub>c</sub> = 25°C (Note. 1, 5)	2450	W
I <sub>E</sub> (Note.3)	Emitter current	T <sub>c</sub> = 25°C (Note. 1)	400	A
I <sub>ERM</sub> (Note.3)	(Free wheeling diode forward current)	Pulse (Note. 4)	800	
T <sub>j</sub>	Junction temperature		-40 ~ +150	°C
T <sub>stg</sub>	Storage temperature		-40 ~ +125	
V <sub>iso</sub>	Isolation voltage	Terminals to base plate, f = 60Hz, AC 1 minute	2500	V <sub>rms</sub>
—	Base plate flatness	On the centerline X, Y (Note. 8)	±0 ~ +100	μm
—	Torque strength	Main terminals M6 screw	3.5 ~ 4.5	N·m
—	Torque strength	Mounting M5 screw	2.5 ~ 3.5	
—	Weight	(Typical)	330	g

Note. 8: The base plate flatness measurement points are in the following figure.

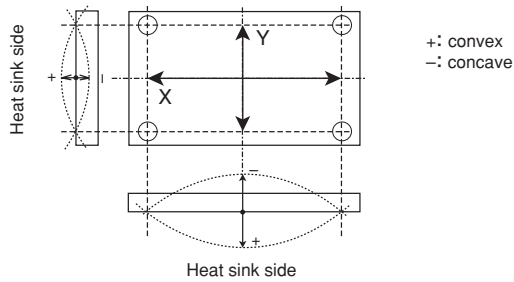

CM400HX-24A

HIGH POWER SWITCHING USE

ELECTRICAL CHARACTERISTICS (Tj = 25°C, unless otherwise specified)

INVERTER PART

Symbol	Parameter	Conditions	Limits			Unit	
			Min.	Typ.	Max.		
ICES	Collector cutoff current	VCE = VCES, VGE = 0V	—	—	1	mA	
VGE(th)	Gate-emitter threshold voltage	IC = 40mA, VCE = 10V	6	7	8	V	
IGES	Gate leakage current	±VGE = VGES, VCE = 0V	—	—	0.5	µA	
VCE(sat)	Collector-emitter saturation voltage	IC = 400A, VGE = 15V (Note. 6)	Tj = 25°C	—	2.0	2.6	V
			Tj = 125°C	—	2.2	—	
		IC = 400A, VGE = 15V	Chip	—	1.9	—	
Cies	Input capacitance	VCE = 10V VGE = 0V (Note. 6)	—	—	66	nF	
Coes	Output capacitance		—	—	6.0		
Cres	Reverse transfer capacitance		—	—	1.3		
QG	Total gate charge	VCC = 600V, IC = 400A, VGE = 15V	—	2000	—	nC	
td(on)	Turn-on delay time	VCC = 600V, IC = 400A	—	—	660	ns	
tr	Turn-on rise time	VGE = ±15V, RG = 0.75Ω	—	—	190		
td(off)	Turn-off delay time	Inductive load	—	—	700		
tf	Turn-off fall time		—	—	600		
trr (Note.3)	Reverse recovery time		—	—	250		
Qrr (Note.3)	Reverse recovery charge	(IE = 400A)	—	13	—	µC	
VEC(Note.3)	Emitter-collector voltage	IE = 400A, VGE = 0V (Note. 6)	Tj = 25°C	—	2.6	3.4	V
			Tj = 125°C	—	2.16	—	
		IE = 400A, VGE = 0V	Chip	—	2.5	—	
Rlead	Module lead resistance	Main terminals-chip	—	0.6	—	mΩ	
Rth(j-c)Q	Thermal resistance	per IGBT	—	—	0.033	K/W	
Rth(j-c)R	(Junction to case) (Note. 1)	per free wheeling diode	—	—	0.048		
Rth(c-f)	Contact thermal resistance (Case to heat sink) (Note. 1)	Thermal grease applied (Note. 2)	—	0.015	—		
RGint	Internal gate resistance	Tc = 25°C	2.1	3	3.9	Ω	
		Tc = 125°C	4.2	6	7.8		
RG	External gate resistance		0.75	—	7.8		

NTC THERMISTOR PART

Symbol	Parameter	Conditions	Limits			Unit
			Min.	Typ.	Max.	
R	Zero power resistance	Tc = 25°C	4.85	5.00	5.15	kΩ
ΔR/R	Deviation of resistance	Tc = 100°C, R100 = 493Ω	-7.3	—	+7.8	%
B(25/50)	B constant	Approximate by equation (Note. 7)	—	3375	—	K
P25	Power dissipation	Tc = 25°C	—	—	10	mW

Note. 1: Case temperature (Tc), heat sink temperature (Tf) measured point is just under the chips. (Refer to the figure of the chip location.)

2: Typical value is measured by using thermally conductive grease of λ = 0.9W/(m·K).

3: IE, IERM, VEC, trr and Qrr represent ratings and characteristics of the anti-parallel, emitter-collector free wheeling diode (FWDi).

4: Pulse width and repetition rate should be such that the device junction temperature (Tj) dose not exceed Tjmax rating.

5: Junction temperature (Tj) should not increase beyond 150°C.

6: Pulse width and repetition rate should be such as to cause negligible temperature rise.

(Refer to the figure of the test circuit for VCE(sat) and VEC)

$$7: B(25/50) = \ln\left(\frac{R_{25}}{R_{50}}\right) \left(\frac{1}{T_{25}} - \frac{1}{T_{50}}\right)$$

R25: resistance at absolute temperature T25 [K]; T25 = 25 [°C]+273.15 = 298.15 [K]

R50: resistance at absolute temperature T50 [K]; T50 = 50 [°C]+273.15 = 323.15 [K]

# CM400HX-24A

HIGH POWER SWITCHING USE

### Chip Location (Top view)

Dimensions in mm (tolerance: ±1mm)

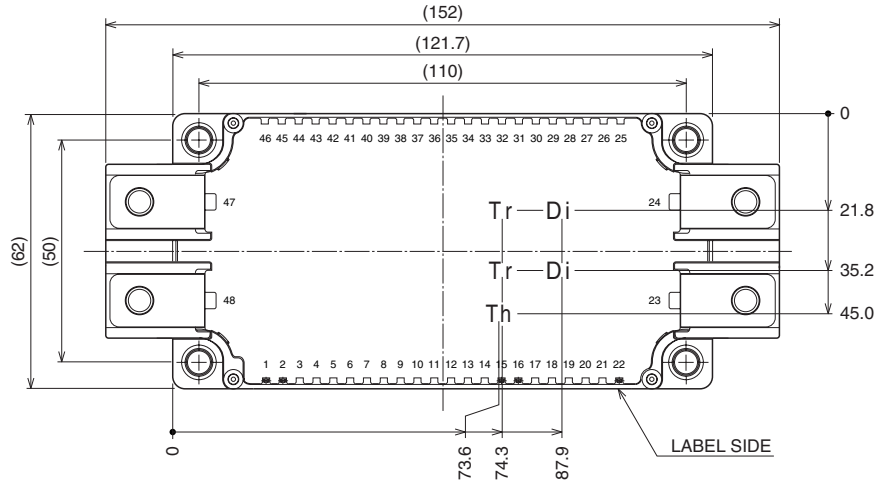

Each mark points the center position of each chip. Tr: IGBT, Di: FWDi, Th: NTC thermistor

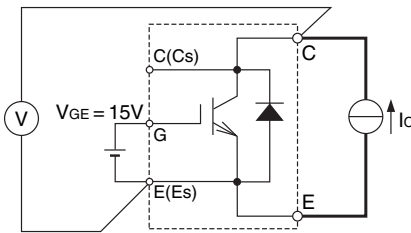

VCE(sat) test circuit

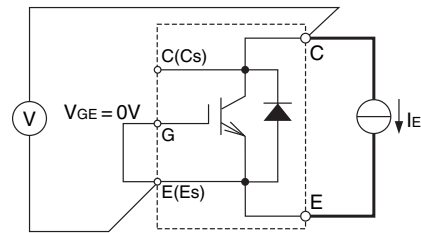

Vec test circuit

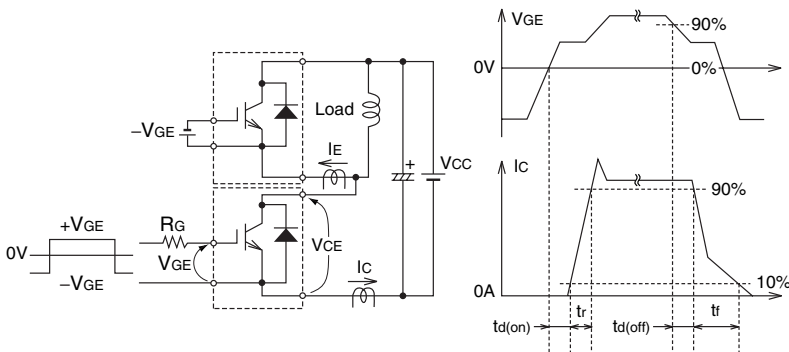

Switching time test circuit and waveforms

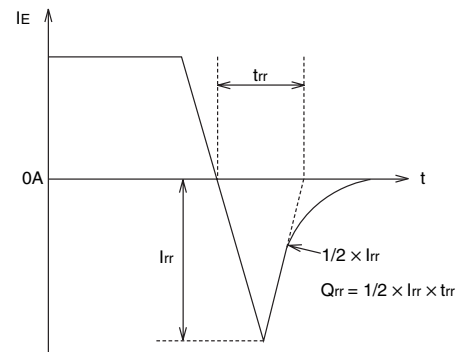

trr, Qrr test waveform

PERFORMANCE CURVES

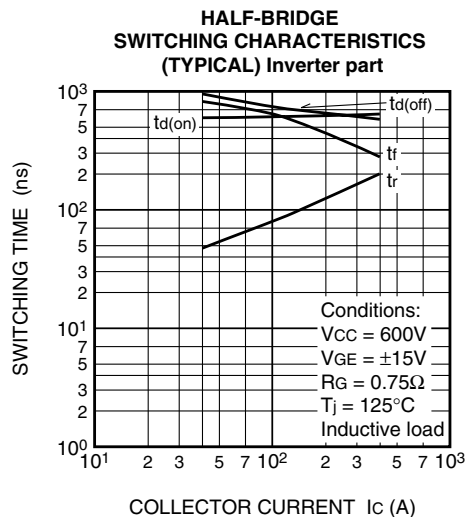
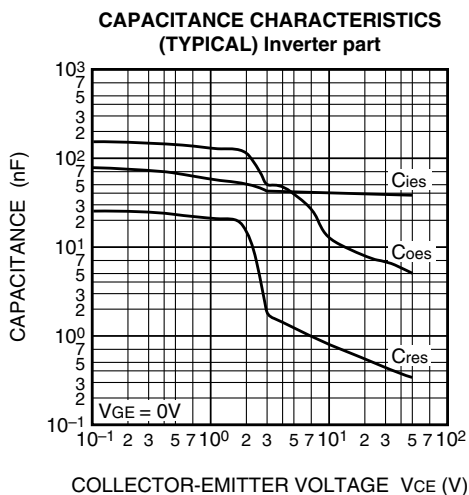
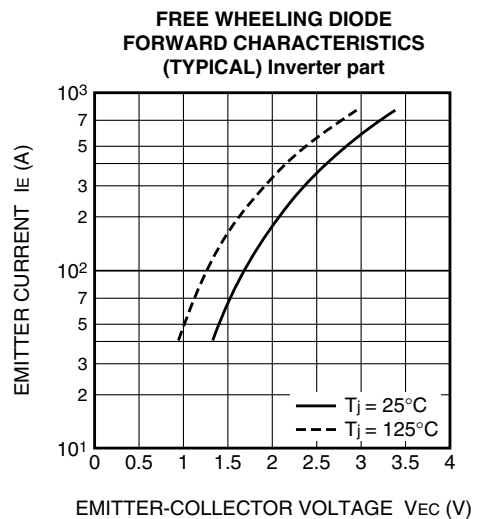
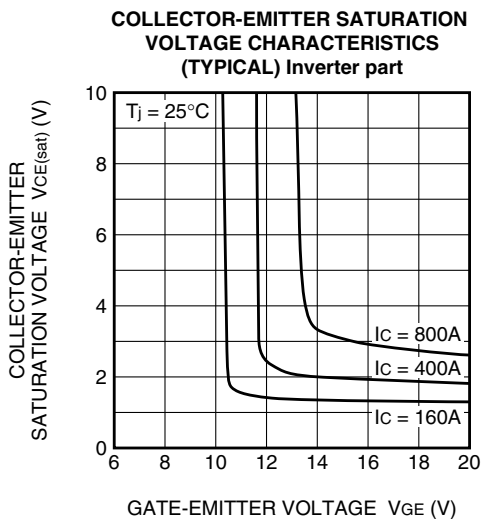
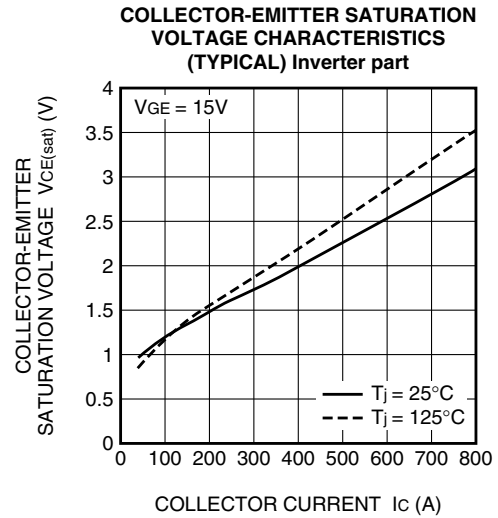
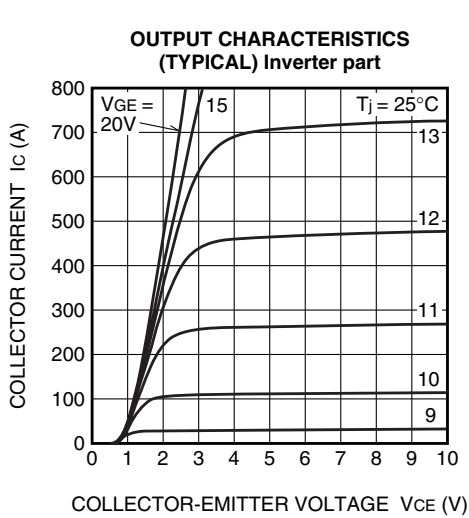

HALF-BRIDGE SWITCHING CHARACTERISTICS (TYPICAL) Inverter part

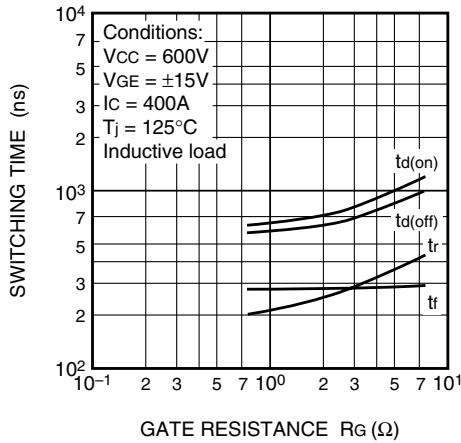

HALF-BRIDGE SWITCHING CHARACTERISTICS (TYPICAL) Inverter part

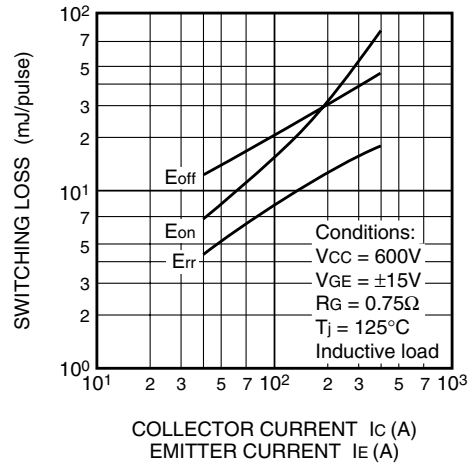

HALF-BRIDGE SWITCHING CHARACTERISTICS (TYPICAL) Inverter part

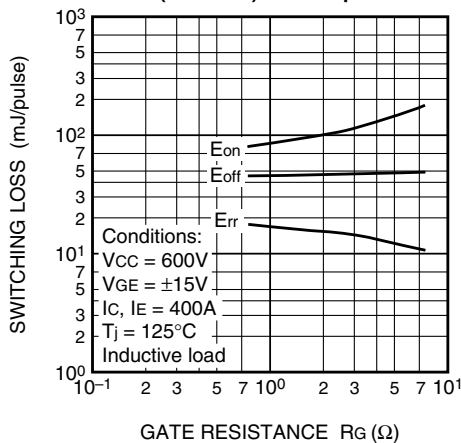

REVERSE RECOVERY CHARACTERISTICS OF FREE WHEELING DIODE (TYPICAL) Inverter part

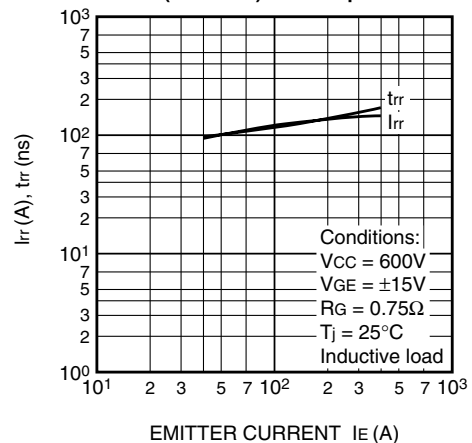

GATE CHARGE CHARACTERISTICS (TYPICAL) Inverter part

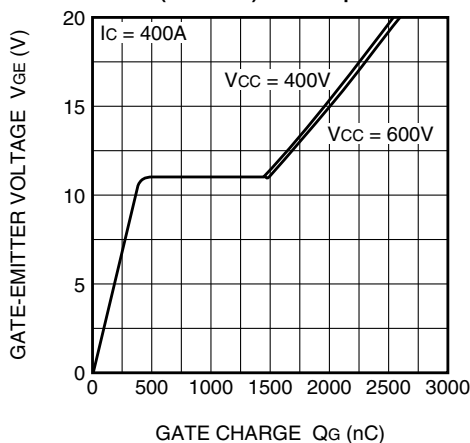

TRANSIENT THERMAL IMPEDANCE CHARACTERISTICS

