

MITSUBISHI IGBT MODULES
CM75TL-24NF

HIGH POWER SWITCHING USE

CM75TL-24NF



- IC 75A
- VCES 1200V
- Insulated Type
- 6-elements in a pack

APPLICATION

AC drive inverters & Servo controls, etc

OUTLINE DRAWING & CIRCUIT DIAGRAM

Dimensions in mm

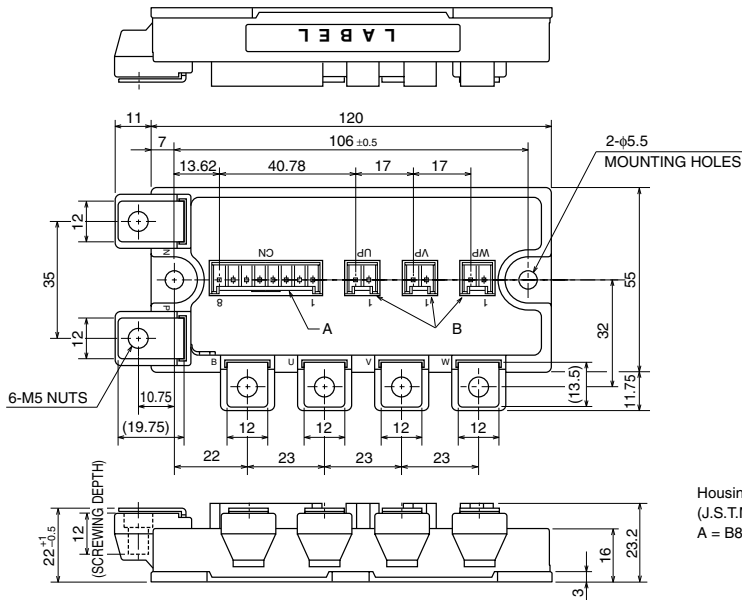

Housing Type of A and B
 (J.S.T.Mfg.Co.Ltd)
 A = B8P-VH-FB-B, B = B2P-VH-FB-B

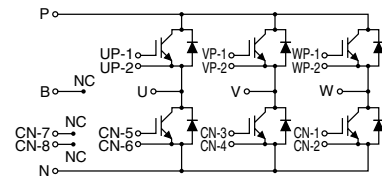

CIRCUIT DIAGRAM

CM75TL-24NF

HIGH POWER SWITCHING USE

ABSOLUTE MAXIMUM RATINGS (T_j = 25°C, unless otherwise specified)

Symbol	Parameter	Conditions	Ratings	Unit
V _{CE} S	Collector-emitter voltage	G-E Short	1200	V
V _{GE} S	Gate-emitter voltage	C-E Short	±20	V
I _C	Collector current	DC, T _C = 87°C ^{*1}	75	A
I _{CM}		Pulse (Note 2)	150	A
I _E (Note 1)	Emitter current		75	A
I _{EM} (Note 1)		Pulse (Note 2)	150	A
P _C (Note 3)	Maximum collector dissipation	T _C = 25°C	520	W
T _j	Junction temperature		-40 ~ +150	°C
T _{stg}	Storage temperature		-40 ~ +125	°C
V _{iso}	Isolation voltage	Terminals to base plate, f = 60Hz, AC 1 minute	2500	V _{rms}
—	Torque strength	Main terminals M5 screw	2.5 ~ 3.5	N • m
—		Mounting M5 screw	2.5 ~ 3.5	N • m
—	Weight	Typical value	350	g

ELECTRICAL CHARACTERISTICS (T_j = 25°C, unless otherwise specified)

Symbol	Parameter	Test conditions	Limits			Unit
			Min.	Typ.	Max.	
I _{CES}	Collector cutoff current	V _{CE} = V _{CE} S, V _{GE} = 0V	—	—	1	mA
V _{GE(th)}	Gate-emitter threshold voltage	I _C = 7.5mA, V _{CE} = 10V	6	7	8	V
I _{GES}	Gate leakage current	±V _{GE} = V _{GES} , V _{CE} = 0V	—	—	0.5	µA
V _{CE(sat)}	Collector-emitter saturation voltage	I _C = 75A, V _{GE} = 15V	—	T _j = 25°C 2.1	3.0	V
		T _j = 125°C 2.4		—		
C _{ies}	Input capacitance	V _{CE} = 10V V _{GE} = 0V	—	—	11.5	nF
C _{oes}	Output capacitance		—	—	1.0	nF
C _{res}	Reverse transfer capacitance		—	—	0.23	nF
Q _G	Total gate charge	V _{CC} = 600V, I _C = 75A, V _{GE} = 15V	—	338	—	nC
t _{d(on)}	Turn-on delay time	V _{CC} = 600V, I _C = 75A V _{GE} = ±15V R _G = 4.2Ω, Inductive load I _E = 75A	—	—	100	ns
t _r	Turn-on rise time		—	—	50	ns
t _{d(off)}	Turn-off delay time		—	—	300	ns
t _f	Turn-off fall time		—	—	350	ns
t _{rr} (Note 1)	Reverse recovery time		—	—	120	ns
Q _{rr} (Note 1)	Reverse recovery charge	—	3	—	µC	
V _{EC} (Note 1)	Emitter-collector voltage	I _E = 75A, V _{GE} = 0V	—	—	3.8	V
R _{th(j-c)Q}	Thermal resistance	IGBT part (1/6 module) ^{*1}	—	—	0.24	K/W
R _{th(j-c)R}		FWDi part (1/6 module) ^{*1}	—	—	0.36	K/W
R _{th(c-f)}	Contact thermal resistance	Case to heat sink, Thermal compound Applied (1/6 module) ^{*2}	—	0.085	—	K/W
R _G	External gate resistance		4.2	—	63	Ω

*1 : Case temperature (T_C) measured point is just under the chips.

If you use this value, R_{th(t-a)} should be measured just under the chips.

*2 : Typical value is measured by using thermally conductive grease of λ = 0.9[W/(m • K)].

Note 1. I_E, V_{EC}, t_{rr} & Q_{rr} represent characteristics of the anti-parallel, emitter-collector free-wheel diode (FWDi).

2. Pulse width and repetition rate should be such that the device junction temperature (T_j) does not exceed T_{jmax} rating.

3. Junction temperature (T_j) should not increase beyond 150°C.

4. Pulse width and repetition rate should be such as to cause negligible temperature rise.

CM75TL-24NF

HIGH POWER SWITCHING USE

PERFORMANCE CURVES

OUTPUT CHARACTERISTICS (TYPICAL)

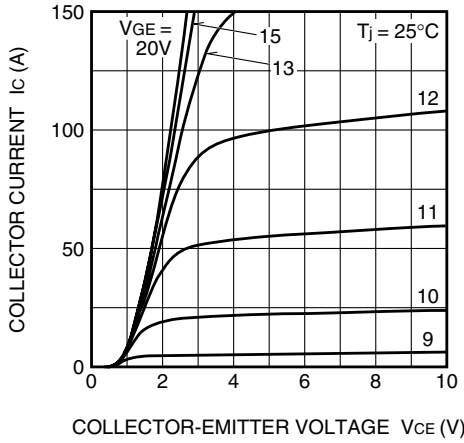

COLLECTOR-EMITTER SATURATION VOLTAGE CHARACTERISTICS (TYPICAL)

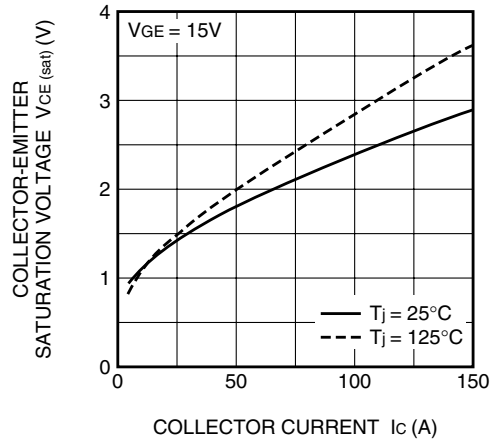

COLLECTOR-EMITTER SATURATION VOLTAGE CHARACTERISTICS (TYPICAL)

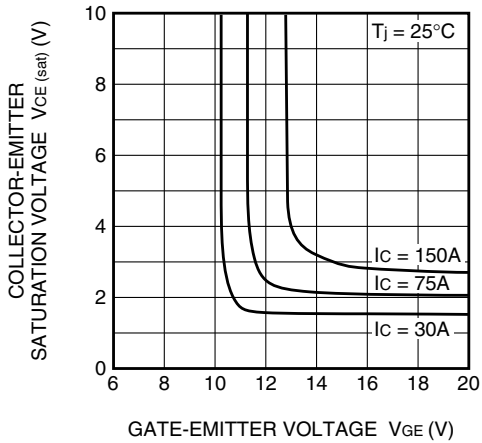

FREE-WHEEL DIODE FORWARD CHARACTERISTICS (TYPICAL)

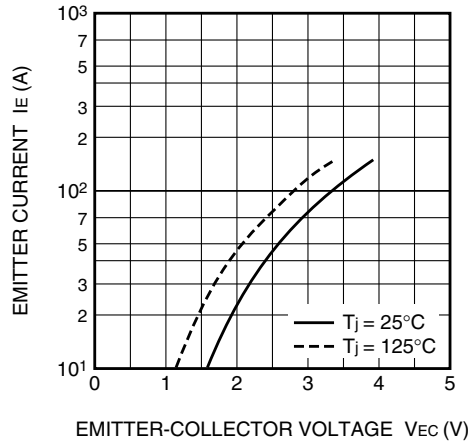

CAPACITANCE-VCE CHARACTERISTICS (TYPICAL)

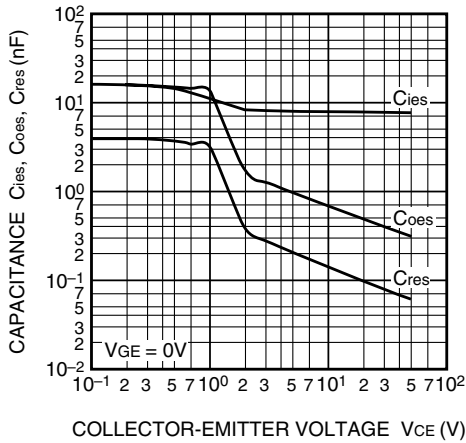

HALF-BRIDGE SWITCHING CHARACTERISTICS (TYPICAL)

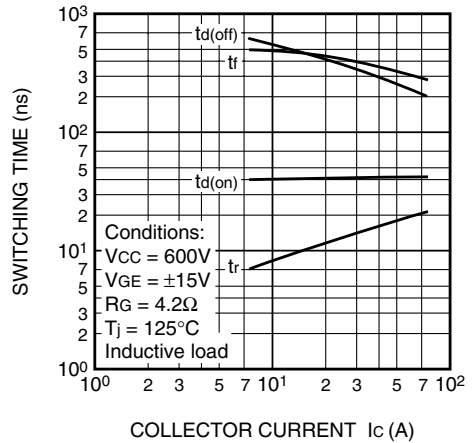

CM75TL-24NF

HIGH POWER SWITCHING USE

REVERSE RECOVERY CHARACTERISTICS OF FREE-WHEEL DIODE (TYPICAL)

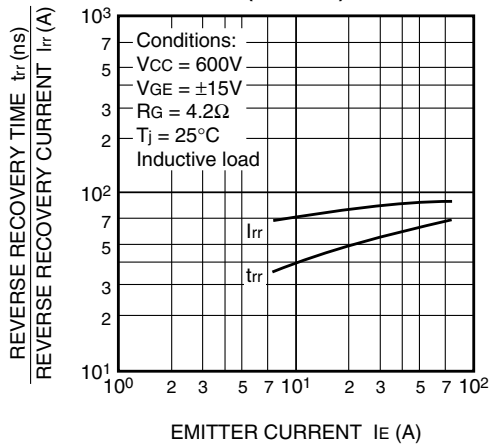

TRANSIENT THERMAL IMPEDANCE CHARACTERISTICS (IGBT part & FWDi part)

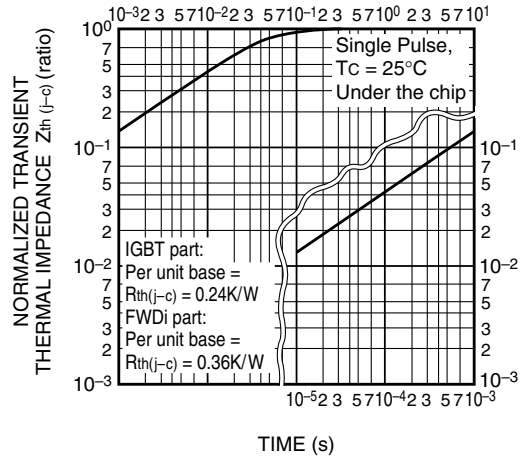

SWITCHING LOSS vs. COLLECTOR CURRENT (TYPICAL)

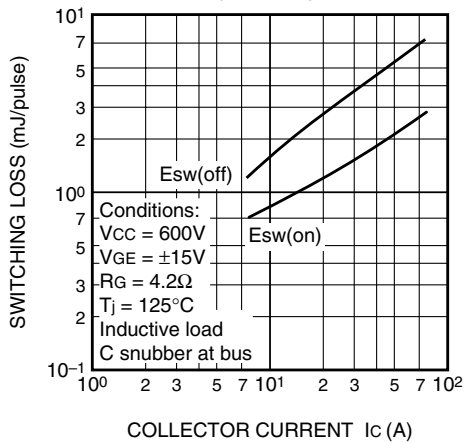

SWITCHING LOSS vs. GATE RESISTANCE (TYPICAL)

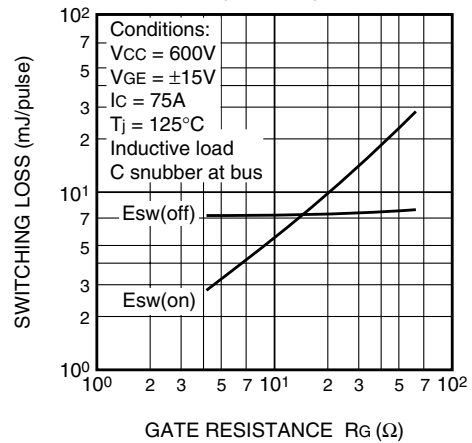

RECOVERY LOSS vs. IE (TYPICAL)

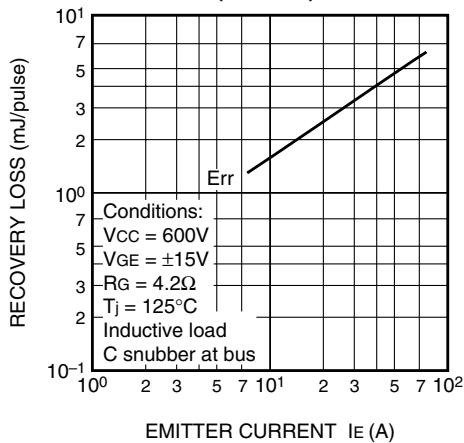

RECOVERY LOSS vs. GATE RESISTANCE (TYPICAL)

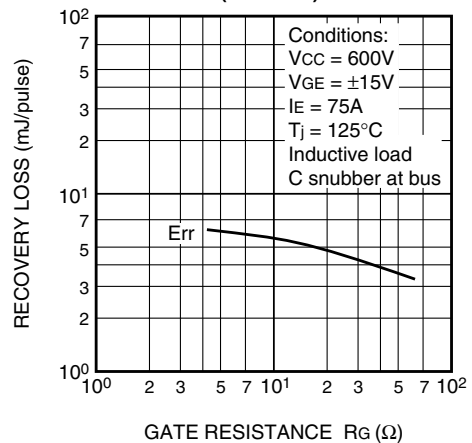

CM75TL-24NF

HIGH POWER SWITCHING USE

