

MITSUBISHI HVIGBT MODULES
CM600HG-130H

3rd-Version HVIGBT (High Voltage Insulated Gate Bipolar Transistor) Modules

HIGH POWER SWITCHING USE
 INSULATED TYPE

CM600HG-130H



- IC 600 A
- VCES 6500 V
- High Insulated Type
- 1-element in a Pack
- AISiC Baseplate

APPLICATION

Traction drives, High Reliability Converters / Inverters, DC choppers

OUTLINE DRAWING & CIRCUIT DIAGRAM

Dimensions in mm

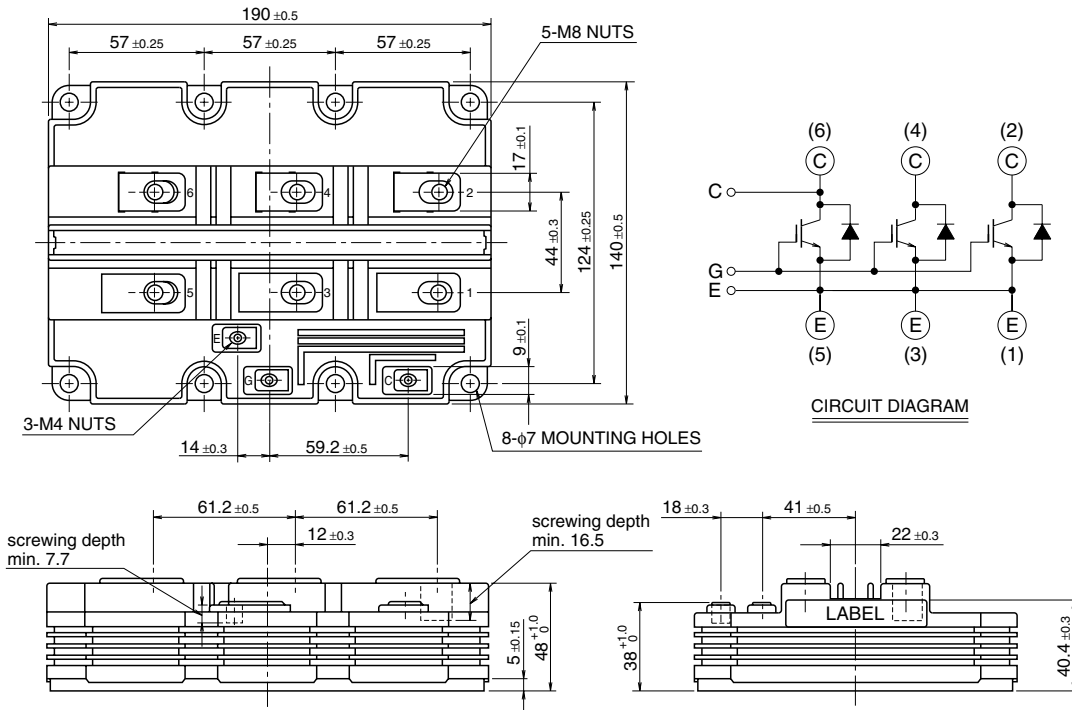

HVIGBT (High Voltage Insulated Gate Bipolar Transistor) Modules

May 2009

CM600HG-130H

**HIGH POWER SWITCHING USE
INSULATED TYPE**

3rd-Version HVIGBT (High Voltage Insulated Gate Bipolar Transistor) Modules

MAXIMUM RATINGS

Symbol	Item	Conditions	Ratings	Unit	
V _{CES}	Collector-emitter voltage	V _{GE} = 0V	T _J = -40°C	5800	V
			T _J = +25°C	6300	
			T _J = +125°C	6500	
V _{GES}	Gate-emitter voltage	V _{CE} = 0V, T _J = 25°C	± 20	V	
I _C	Collector current	DC, T _c = 80°C	600	A	
I _{CM}		Pulse (Note 1)	1200	A	
I _E	Emitter current (Note 2)	DC	600	A	
I _{EM}		Pulse (Note 1)	1200	A	
P _c	Maximum power dissipation (Note 3)	T _c = 25°C, IGBT part	8900	W	
V _{iso}	Isolation voltage	RMS, sinusoidal, f = 60Hz, t = 1 min.	10200	V	
V _e	Partial discharge extinction voltage	RMS, sinusoidal, f = 60Hz, Q _{PD} ≤ 10 pC	5100	V	
T _J	Junction temperature		-40 ~ +150	°C	
T _{op}	Operating temperature		-40 ~ +125	°C	
T _{stg}	Storage temperature		-40 ~ +125	°C	
t _{psc}	Maximum short circuit pulse width	V _{CC} = 4500V, V _{CE} ≤ V _{CES} , V _{GE} = 15V, T _J = 125°C	10	μs	

ELECTRICAL CHARACTERISTICS

Symbol	Item	Conditions	Limits			Unit	
			Min	Typ	Max		
I _{CES}	Collector cutoff current	V _{CE} = V _{CES} , V _{GE} = 0V	T _J = 25°C	—	—	10	mA
			T _J = 125°C	—	30	90	
V _{GE(th)}	Gate-emitter threshold voltage	V _{CE} = 10 V, I _C = 60 mA, T _J = 25°C	5.0	6.0	7.0	V	
I _{GES}	Gate leakage current	V _{GE} = V _{GES} , V _{CE} = 0V, T _J = 25°C	-0.5	—	0.5	μA	
C _{ies}	Input capacitance	V _{CE} = 10 V, V _{GE} = 0 V, f = 100 kHz, T _J = 25°C	—	124	—	nF	
C _{oes}	Output capacitance		—	7.6	—	nF	
C _{res}	Reverse transfer capacitance		—	2.2	—	nF	
Q _g	Total gate charge		V _{CC} = 3600 V, I _C = 600 A, V _{GE} = ±15 V, T _J = 25°C	—	9.9	—	μC
V _{CE(sat)}	Collector-emitter saturation voltage	I _C = 600 A (Note 4) V _{GE} = 15 V	T _J = 25°C	—	4.50	—	V
			T _J = 125°C	—	4.60	—	
t _{d(on)}	Turn-on delay time	V _{CC} = 3600 V, I _C = 600 A, V _{GE} = ±15 V R _{G(on)} = 10 Ω, T _J = 125°C, L _s = 150 nH	—	1.20	—	μs	
t _r	Turn-on rise time		—	0.35	—	μs	
E _{on(10%)}	Turn-on switching energy (Note 5)	t _(IGBT_off) = 60 μs ^(Note 6) , Inductive load	—	4.50	—	J/P	
t _{d(off)}	Turn-off delay time	V _{CC} = 3600 V, I _C = 600 A, V _{GE} = ±15 V R _{G(off)} = 33 Ω, T _J = 125°C, L _s = 150 nH Inductive load	—	8.20	—	μs	
t _f	Turn-off fall time		—	0.50	—	μs	
t _{f2}	Turn-off fall time		—	3.10	—	μs	
E _{off(10%)}	Turn-off switching energy (Note 5)		—	4.30	—	J/P	
V _{EC}	Emitter-collector voltage (Note 2)	I _E = 600 A (Note 4) V _{GE} = 0 V	T _J = 25°C	—	4.00	—	V
			T _J = 125°C	—	3.60	—	
t _{rr}	Reverse recovery time (Note 2)	V _{CC} = 3600 V, I _E = 600 A, V _{GE} = ±15 V R _{G(on)} = 10 Ω, T _J = 125°C, L _s = 150 nH t _(IGBT_off) = 60 μs ^(Note 6) , Inductive load	—	1.00	—	μs	
t _{rr2}	Reverse recovery time (Note 2)		—	2.40	—	μs	
Q _{rr}	Reverse recovery charge (Note 2)		—	1100	—	μC	
E _{rec(10%)}	Reverse recovery energy (Note 2), (Note 5)		—	2.00	—	J/P	

CM600HG-130H

HIGH POWER SWITCHING USE
INSULATED TYPE

3rd-Version HVIGBT (High Voltage Insulated Gate Bipolar Transistor) Modules

THERMAL CHARACTERISTICS

Symbol	Item	Conditions	Limits			Unit
			Min	Typ	Max	
$R_{th(j-c)Q}$	Thermal resistance	Junction to Case, IGBT part	—	—	14.0	K/kW
$R_{th(j-c)R}$	Thermal resistance	Junction to Case, FWDi part	—	—	22.0	K/kW
$R_{th(c-f)}$	Contact thermal resistance	Case to Fin, $\lambda_{grease} = 1W/m-K$, $D(c-f) = 100 \mu m$	—	6.0	—	K/kW

MECHANICAL CHARACTERISTICS

Symbol	Item	Conditions	Limits			Unit
			Min	Typ	Max	
M_t	Mounting torque	M8: Main terminals screw	7.0	—	15.0	N·m
M_s		M6: Mounting screw	3.0	—	6.0	N·m
M_t		M4: Auxiliary terminals screw	1.0	—	3.0	N·m
m	Mass		—	1.35	—	kg
CTI	Comparative tracking index		600	—	—	—
d_a	Clearance		26	—	—	mm
d_s	Creepage distance		56	—	—	mm
LP CE	Internal inductance		—	17	—	nH
R_{CC+EE}	Internal lead resistance	$T_c = 25^\circ C$	—	0.14	—	mΩ

- Note 1. Pulse width and repetition rate should be such that junction temperature (T_j) does not exceed T_{opmax} rating (125°C).
 2. The symbols represent characteristics of the anti-parallel, emitter to collector free-wheel diode (FWDi).
 3. Junction temperature (T_j) should not exceed T_{jmax} rating (150°C).
 4. Pulse width and repetition rate should be such as to cause negligible temperature rise.
 5. $E_{on(10\%)} / E_{off(10\%)} / E_{rec(10\%)}$ are the integral of $0.1V_{CE} \times 0.1I_c \times dt$.
 6. $t_{(IGBT_off)}$ definition is shown as follows.

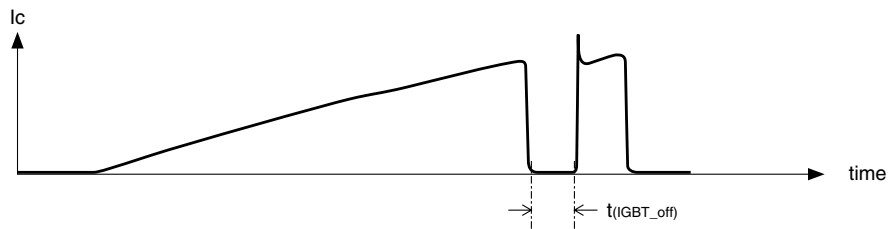

CM600HG-130H

HIGH POWER SWITCHING USE
INSULATED TYPE

3rd-Version HVIGBT (High Voltage Insulated Gate Bipolar Transistor) Modules

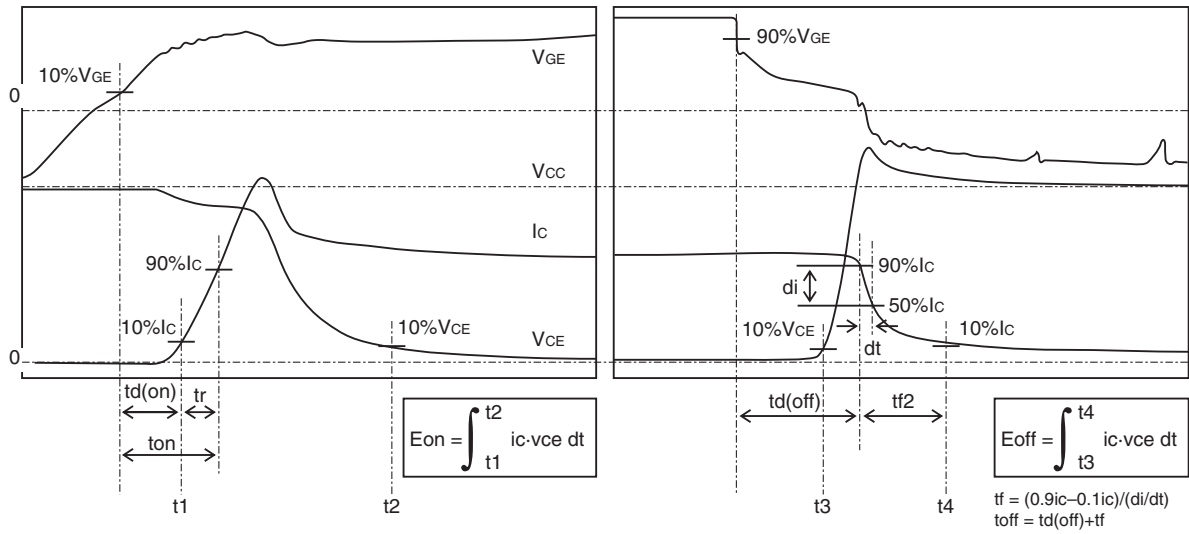

Fig. 1 – Definitions of switching times & energies of IGBT part

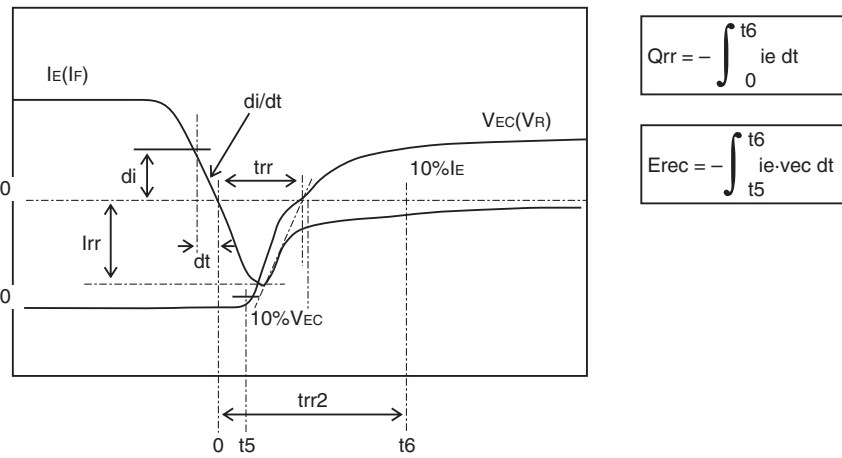

Fig. 2 – Definitions of reverse recovery charge & energy of FWDi part

CM600HG-130H

HIGH POWER SWITCHING USE
INSULATED TYPE

3rd-Version HVIGBT (High Voltage Insulated Gate Bipolar Transistor) Modules

PERFORMANCE CURVES

OUTPUT CHARACTERISTICS (TYPICAL)

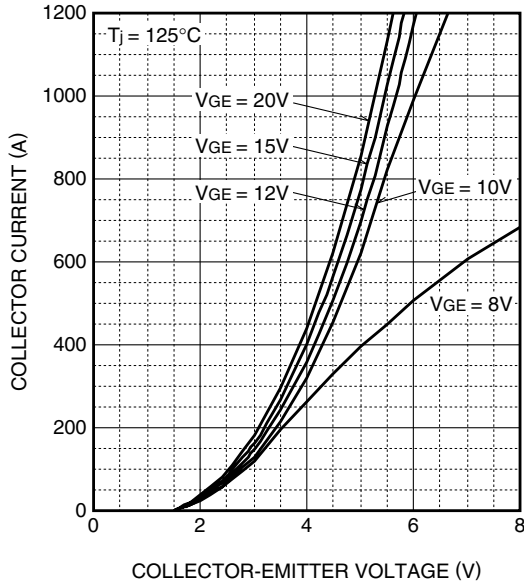

TRANSFER CHARACTERISTICS (TYPICAL)

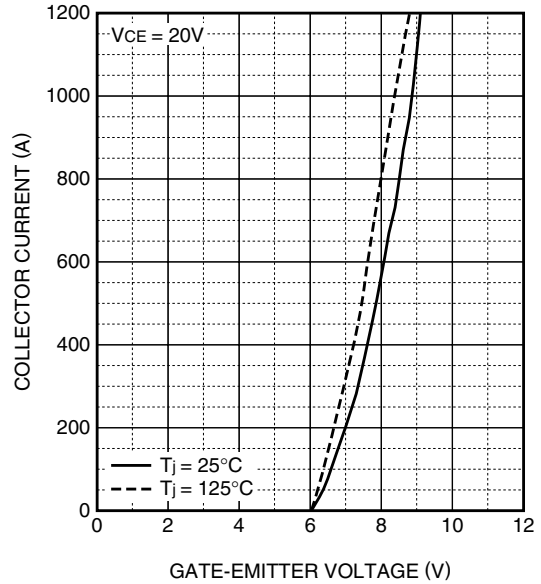

COLLECTOR-EMITTER SATURATION VOLTAGE CHARACTERISTICS (TYPICAL)

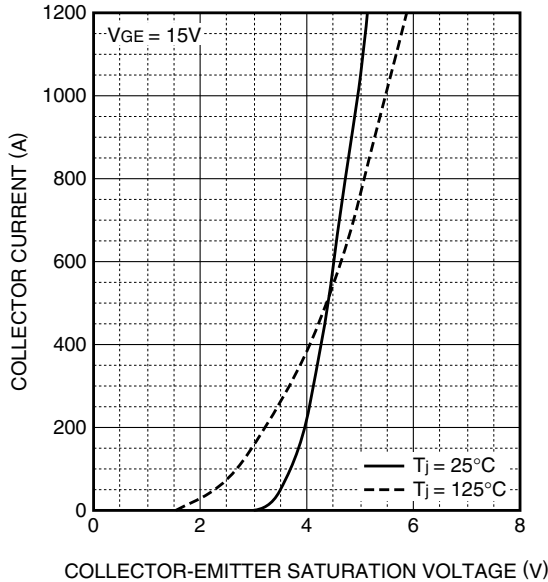

FREE-WHEEL DIODE FORWARD CHARACTERISTICS (TYPICAL)

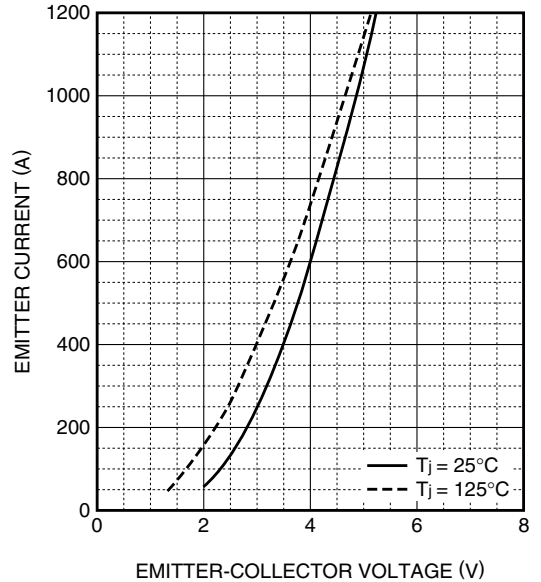

CM600HG-130H

HIGH POWER SWITCHING USE
INSULATED TYPE

3rd-Version HVIGBT (High Voltage Insulated Gate Bipolar Transistor) Modules

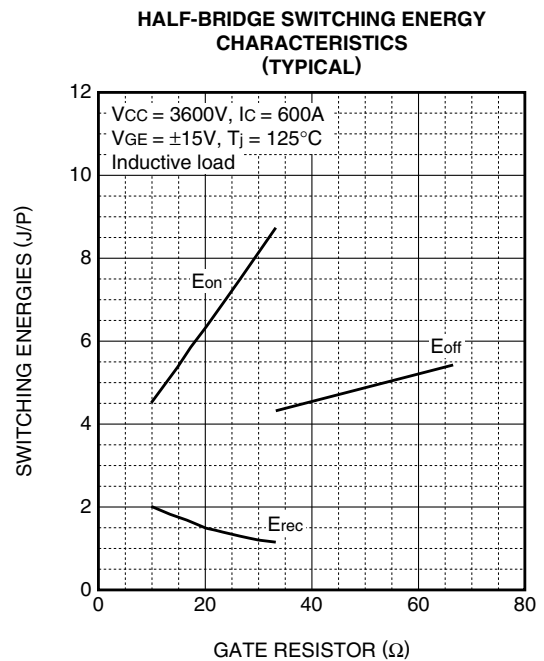
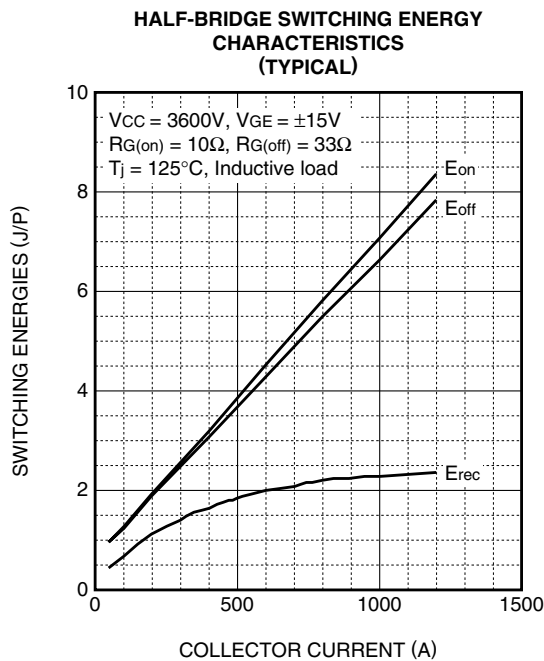
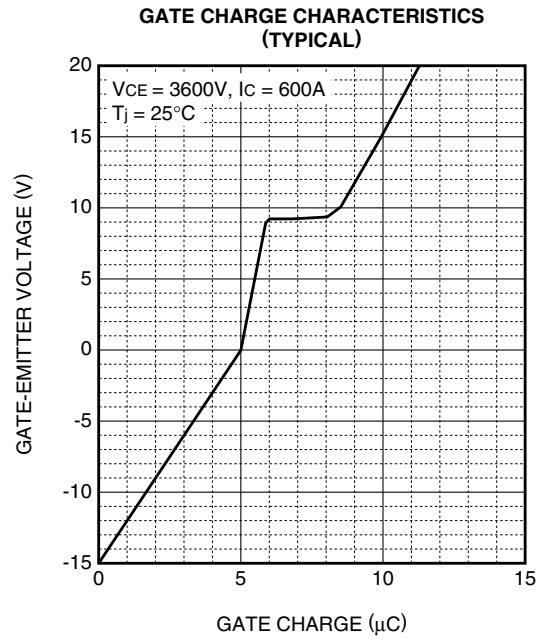
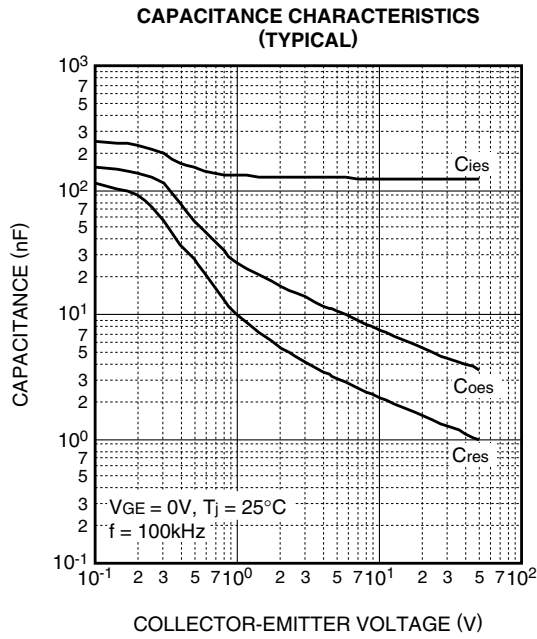

CM600HG-130H

HIGH POWER SWITCHING USE
INSULATED TYPE

3rd-Version HVIGBT (High Voltage Insulated Gate Bipolar Transistor) Modules

HALF-BRIDGE SWITCHING TIME CHARACTERISTICS (TYPICAL)

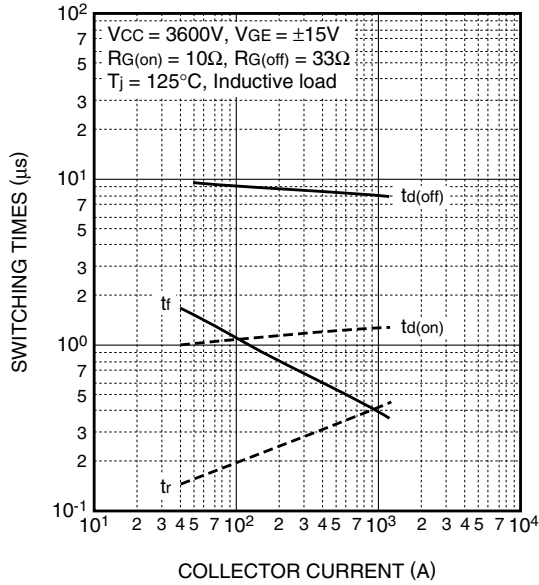

FREE-WHEEL DIODE REVERSE RECOVERY CHARACTERISTICS (TYPICAL)

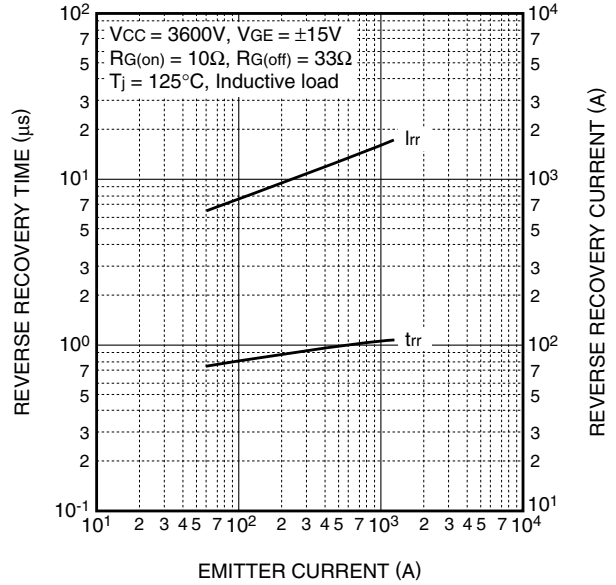

TRANSIENT THERMAL IMPEDANCE CHARACTERISTICS

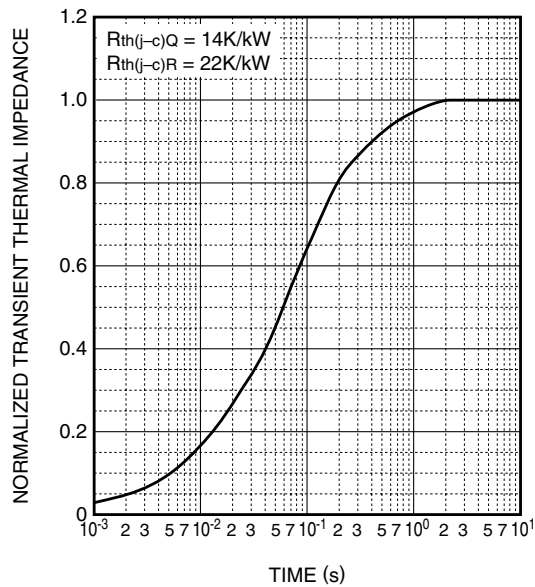

$$Z_{th(j-c)}(t) = \sum_{i=1}^n R_i \left\{ 1 - \exp\left(-\frac{t}{\tau_i}\right) \right\}$$

	1	2	3	4
R_i [K/kW]	0.0059	0.0978	0.6571	0.2392
τ_i [sec]	0.0002	0.0074	0.0732	0.4488

CM600HG-130H

HIGH POWER SWITCHING USE
INSULATED TYPE

3rd-Version HVIGBT (High Voltage Insulated Gate Bipolar Transistor) Modules

REVERSE BIAS SAFE OPERATING AREA (RBSOA)

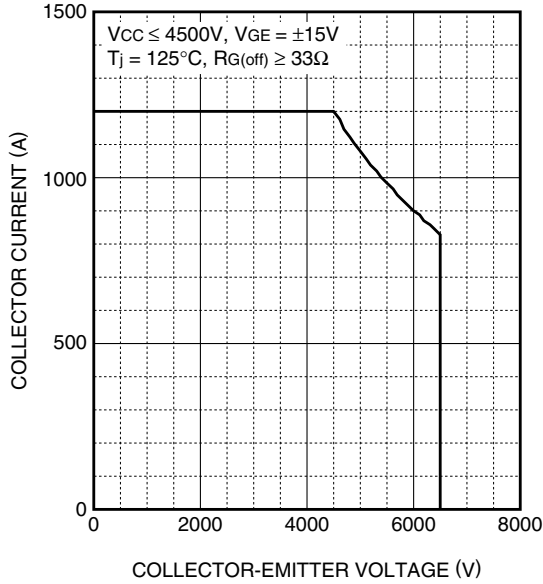

SHORT CIRCUIT SAFE OPERATING AREA (SCSOA)

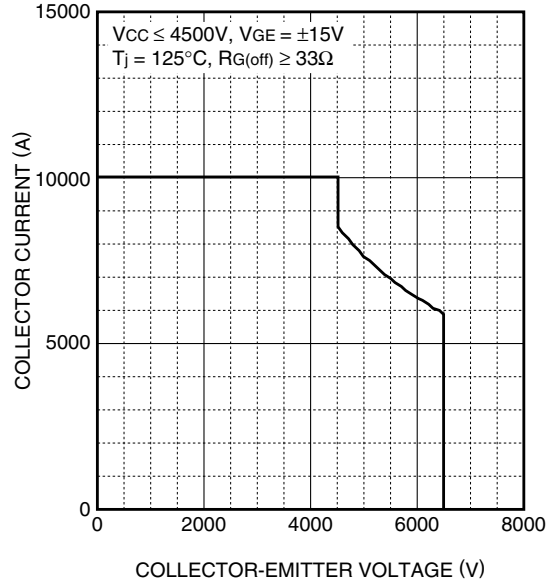

FREE-WHEEL DIODE REVERSE RECOVERY SAFE OPERATING AREA (RRSOA)

