

MITSUBISHI HVIGBT MODULES  
**CM800DZB-34N**

4th-Version HVIGBT (High Voltage Insulated Gate Bipolar Transistor) Modules

HIGH POWER SWITCHING USE  
 INSULATED TYPE

**CM800DZB-34N**



- IC .....800A
- VCES ..... 1700V
- Insulated Type
- 2-element in a Pack
- AISiC Baseplate
- Trench Gate IGBT : CSTBT™
- Soft Reverse Recovery Diode

**APPLICATION**

Traction drives, High Reliability Converters / Inverters, DC choppers

**OUTLINE DRAWING & CIRCUIT DIAGRAM**

Dimensions in mm

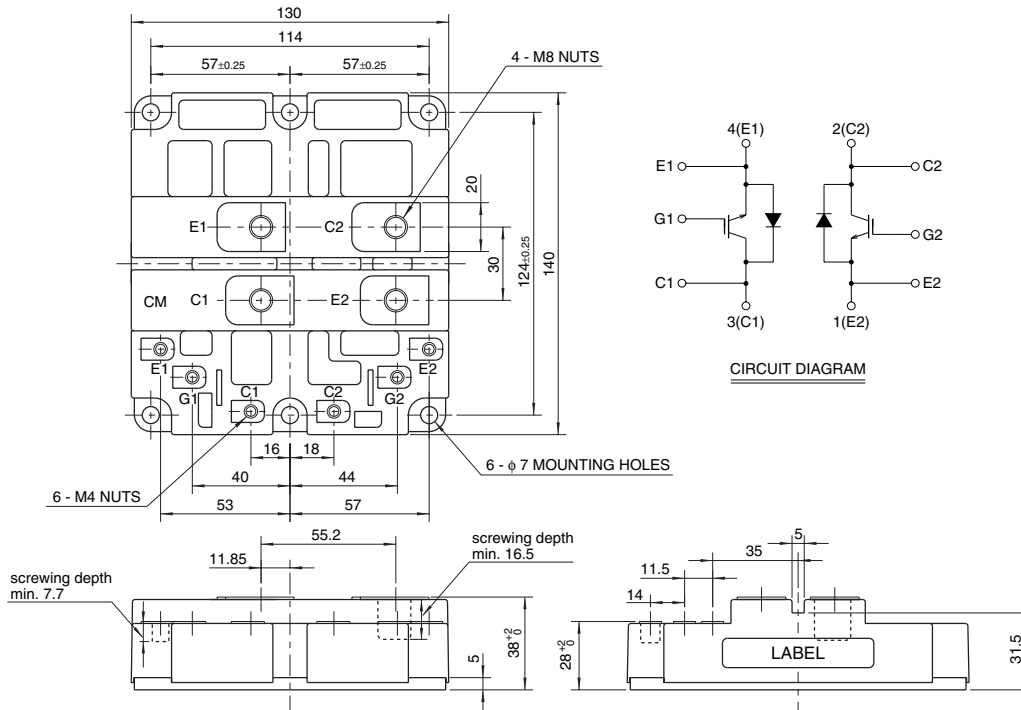

HVIGBT (High Voltage Insulated Gate Bipolar Transistor) Modules

Sep. 2009

**CM800DZB-34N**

**HIGH POWER SWITCHING USE  
INSULATED TYPE**

4th-Version HVIGBT (High Voltage Insulated Gate Bipolar Transistor) Modules

**MAXIMUM RATINGS**

Symbol	Item	Conditions	Ratings	Unit
V <sub>CES</sub>	Collector-emitter voltage	V <sub>GE</sub> = 0V, T <sub>J</sub> = 25°C	1700	V
V <sub>GES</sub>	Gate-emitter voltage	V <sub>CE</sub> = 0V, T <sub>J</sub> = 25°C	± 20	V
I <sub>C</sub>	Collector current	DC, T <sub>c</sub> = 80°C	800	A
I <sub>CM</sub>		Pulse (Note 1)	1600	A
I <sub>E</sub>	Emitter current (Note 2)	DC	800	A
I <sub>EM</sub>		Pulse (Note 1)	1600	A
P <sub>c</sub>	Maximum power dissipation (Note 3)	T <sub>c</sub> = 25°C, IGBT part	5200	W
V <sub>iso</sub>	Isolation voltage	RMS, sinusoidal, f = 60Hz, t = 1 min.	4000	V
T <sub>J</sub>	Junction temperature		-40 ~ +150	°C
T <sub>op</sub>	Operating temperature		-40 ~ +125	°C
T <sub>stg</sub>	Storage temperature		-40 ~ +125	°C
t <sub>psc</sub>	Maximum short circuit pulse width	V <sub>CC</sub> = 1000V, V <sub>CE</sub> ≤ V <sub>CES</sub> , V <sub>GE</sub> = 15V, T <sub>J</sub> = 125°C	10	μs

**ELECTRICAL CHARACTERISTICS**

Symbol	Item	Conditions	Limits			Unit	
			Min	Typ	Max		
I <sub>CES</sub>	Collector cutoff current	V <sub>CE</sub> = V <sub>CES</sub> , V <sub>GE</sub> = 0V	T <sub>J</sub> = 25°C	—	—	3	mA
			T <sub>J</sub> = 125°C	—	2.5	6	
V <sub>GE(th)</sub>	Gate-emitter threshold voltage	V <sub>CE</sub> = 10 V, I <sub>C</sub> = 80 mA, T <sub>J</sub> = 25°C	5.5	6.5	7.5	V	
I <sub>GES</sub>	Gate leakage current	V <sub>GE</sub> = V <sub>GES</sub> , V <sub>CE</sub> = 0V, T <sub>J</sub> = 25°C	—	—	0.5	μA	
C <sub>ies</sub>	Input capacitance	V <sub>CE</sub> = 10 V, V <sub>GE</sub> = 0 V, f = 100 kHz, T <sub>J</sub> = 25°C	—	132	—	nF	
C <sub>oes</sub>	Output capacitance		—	7.2	—	nF	
C <sub>res</sub>	Reverse transfer capacitance		—	2.1	—	nF	
Q <sub>g</sub>	Total gate charge	V <sub>CC</sub> = 900 V, I <sub>C</sub> = 800 A, V <sub>GE</sub> = ±15 V, T <sub>J</sub> = 25°C	—	9.1	—	μC	
V <sub>CE(sat)</sub>	Collector-emitter saturation voltage	I <sub>C</sub> = 800 A (Note 4) V <sub>GE</sub> = 15 V	T <sub>J</sub> = 25°C	—	2.10	2.70	V
			T <sub>J</sub> = 125°C	—	2.35	—	
t <sub>d(on)</sub>	Turn-on delay time	V <sub>CC</sub> = 900 V, I <sub>C</sub> = 800 A, V <sub>GE</sub> = ±15 V R <sub>G(on)</sub> = 1.6 Ω, T <sub>J</sub> = 125°C, L <sub>s</sub> = 150 nH	—	—	1.50	μs	
t <sub>r</sub>	Turn-on rise time		—	—	0.60	μs	
E <sub>on(10%)</sub>	Turn-on switching energy (Note 5)	Inductive load	—	0.30	—	J/P	
t <sub>d(off)</sub>	Turn-off delay time	V <sub>CC</sub> = 900 V, I <sub>C</sub> = 800 A, V <sub>GE</sub> = ±15 V R <sub>G(off)</sub> = 3.9 Ω, T <sub>J</sub> = 125°C, L <sub>s</sub> = 150 nH	—	—	3.00	μs	
t <sub>f</sub>	Turn-off fall time		—	—	0.60	μs	
E <sub>off(10%)</sub>	Turn-off switching energy (Note 5)	Inductive load	—	0.20	—	J/P	
V <sub>EC</sub>	Emitter-collector voltage (Note 2)	I <sub>E</sub> = 800 A (Note 4) V <sub>GE</sub> = 0 V	T <sub>J</sub> = 25°C	—	2.20	3.00	V
			T <sub>J</sub> = 125°C	—	1.85	—	
t <sub>rr</sub>	Reverse recovery time (Note 2)	V <sub>CC</sub> = 900 V, I <sub>E</sub> = 800 A, V <sub>GE</sub> = ±15 V R <sub>G(on)</sub> = 1.6 Ω, T <sub>J</sub> = 125°C, L <sub>s</sub> = 150 nH Inductive load	—	—	1.50	μs	
Q <sub>rr</sub>	Reverse recovery charge (Note 2)		—	260	—	μC	
E <sub>rec(10%)</sub>	Reverse recovery energy (Note 2), (Note 5)		—	0.18	—	J/P	

**CM800DZB-34N**

**HIGH POWER SWITCHING USE  
INSULATED TYPE**

4th-Version HVIGBT (High Voltage Insulated Gate Bipolar Transistor) Modules

**THERMAL CHARACTERISTICS**

Symbol	Item	Conditions	Limits			Unit
			Min	Typ	Max	
$R_{th(j-c)Q}$	Thermal resistance: IGBT part	Junction to Case, 1/2 module	—	—	24.0	K/kW
$R_{th(j-c)R}$	Thermal resistance: FWDi part	Junction to Case, 1/2 module	—	—	36.0	K/kW
$R_{th(c-f)}$	Contact thermal resistance	Case to Fin, $\lambda_{grease} = 1W/m\cdot K$ , $D_{(c-f)} = 100 \mu m$ , 1/2 module	—	18.0	—	K/kW

**MECHANICAL CHARACTERISTICS**

Symbol	Item	Conditions	Limits			Unit
			Min	Typ	Max	
$M_t$	Mounting torque	M8: Main terminals screw	7.0	—	13.0	N·m
$M_s$		M6: Mounting screw	3.0	—	6.0	N·m
$M_t$		M4: Auxiliary terminals screw	1.0	—	2.0	N·m
m	Mass		—	1.0	—	kg
CTI	Comparative tracking index		600	—	—	—
$d_a$	Clearance		19.5	—	—	mm
$d_s$	Creepage distance		32.0	—	—	mm
$L_{PCE}$	Parasitic stray inductance		—	18	—	nH
$R_{CC+EE}$	Internal lead resistance	$T_c = 25^\circ C$	—	0.30	—	mΩ

- Note 1. Pulse width and repetition rate should be such that junction temperature ( $T_j$ ) does not exceed  $T_{opmax}$  rating (125°C).  
 2. The symbols represent characteristics of the anti-parallel, emitter to collector free-wheel diode (FWDi).  
 3. Junction temperature ( $T_j$ ) should not exceed  $T_{jmax}$  rating (150°C).  
 4. Pulse width and repetition rate should be such as to cause negligible temperature rise.  
 5.  $E_{on(10\%)} / E_{off(10\%)} / E_{rec(10\%)}$  are the integral of  $0.1V_{CE} \times 0.1I_C \times dt$ .

**CM800DZB-34N**

**HIGH POWER SWITCHING USE  
INSULATED TYPE**

4th-Version HVIGBT (High Voltage Insulated Gate Bipolar Transistor) Modules

**PERFORMANCE CURVES**

**OUTPUT CHARACTERISTICS  
(TYPICAL)**

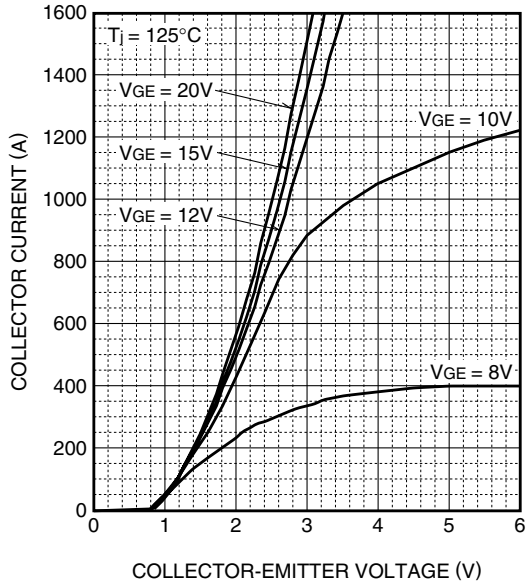

**TRANSFER CHARACTERISTICS  
(TYPICAL)**

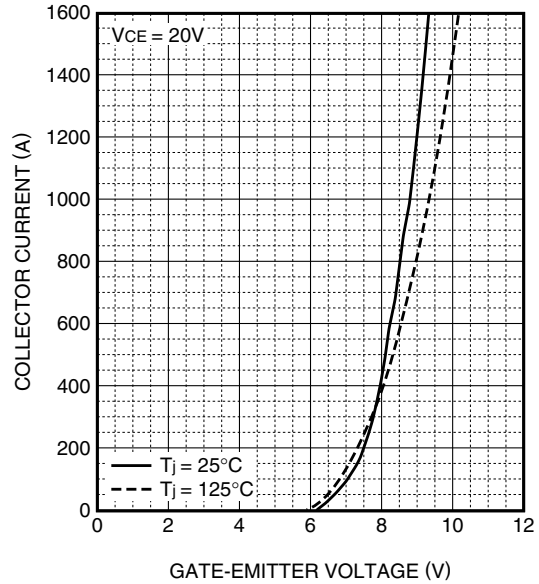

**COLLECTOR-EMITTER SATURATION  
VOLTAGE CHARACTERISTICS  
(TYPICAL)**

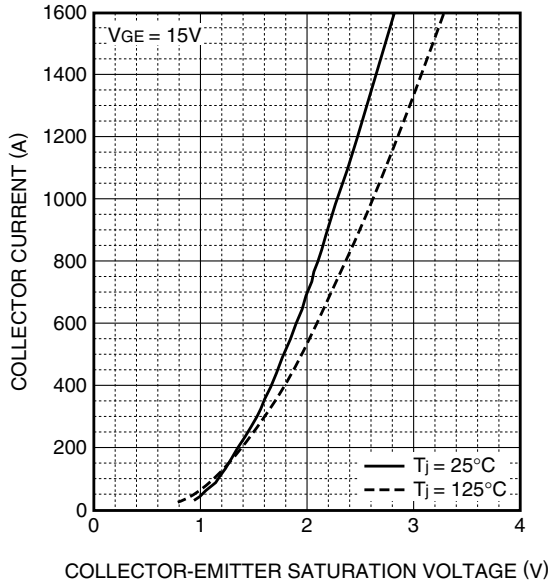

**FREE-WHEEL DIODE  
FORWARD CHARACTERISTICS  
(TYPICAL)**

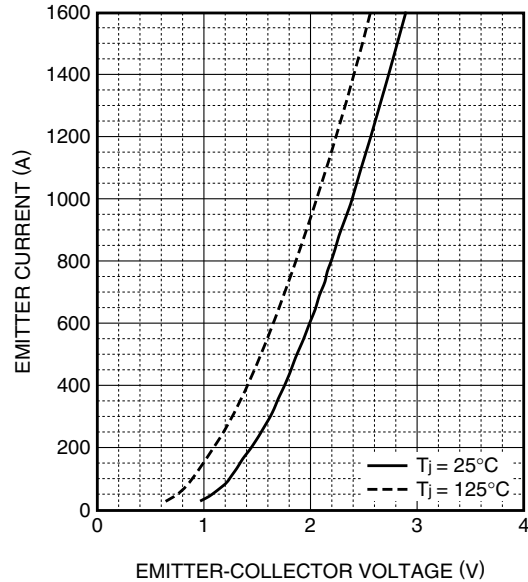

**CM800DZB-34N**

**HIGH POWER SWITCHING USE  
INSULATED TYPE**

4th-Version HVIGBT (High Voltage Insulated Gate Bipolar Transistor) Modules

**CAPACITANCE CHARACTERISTICS  
(TYPICAL)**

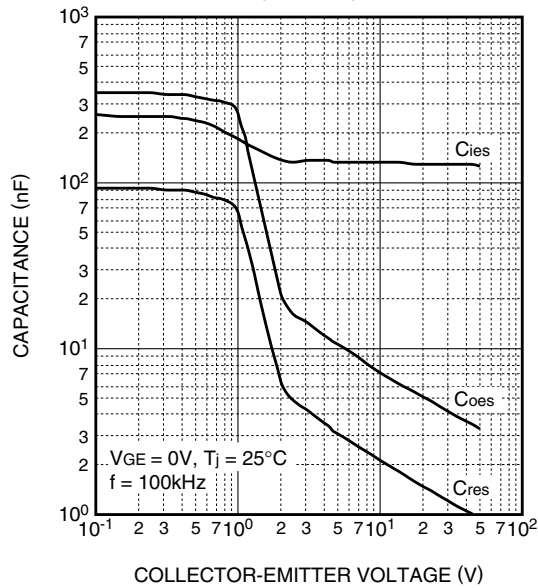

**GATE CHARGE CHARACTERISTICS  
(TYPICAL)**

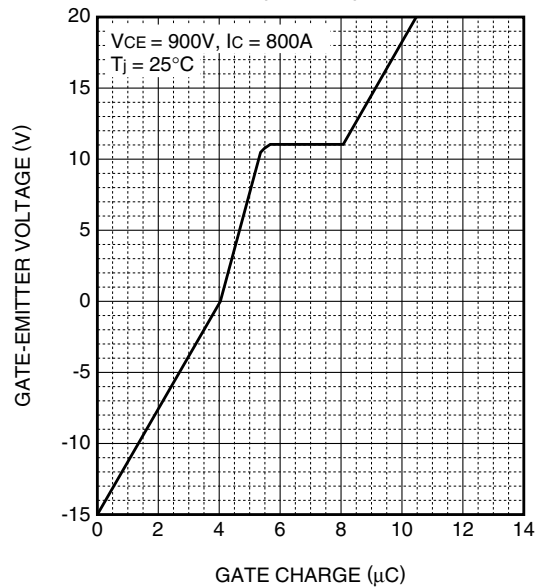

**HALF-BRIDGE SWITCHING ENERGY  
CHARACTERISTICS  
(TYPICAL)**

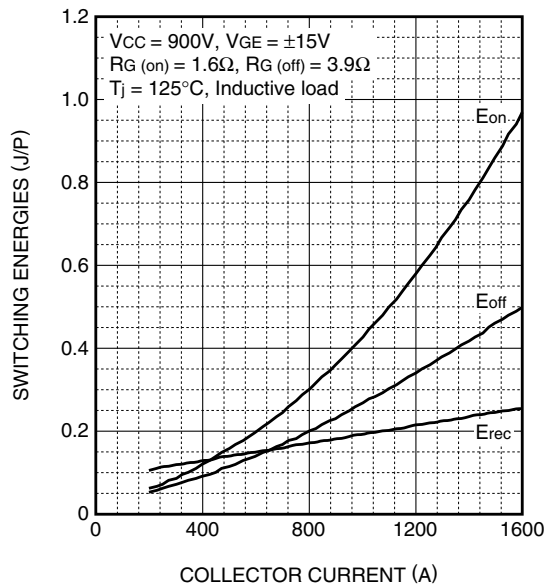

**HALF-BRIDGE SWITCHING ENERGY  
CHARACTERISTICS  
(TYPICAL)**

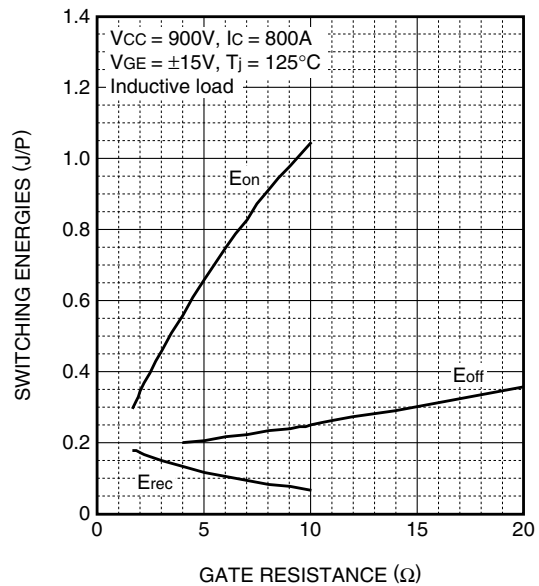

CM800DZB-34N

HIGH POWER SWITCHING USE  
INSULATED TYPE

4th-Version HVIGBT (High Voltage Insulated Gate Bipolar Transistor) Modules

HALF-BRIDGE SWITCHING TIME CHARACTERISTICS (TYPICAL)

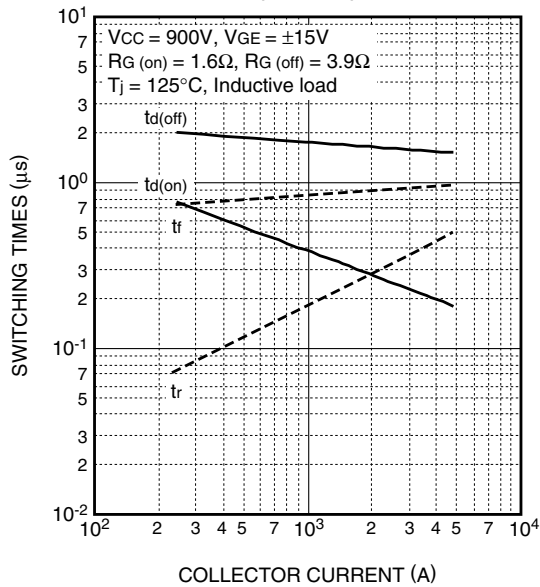

FREE-WHEEL DIODE REVERSE RECOVERY CHARACTERISTICS (TYPICAL)

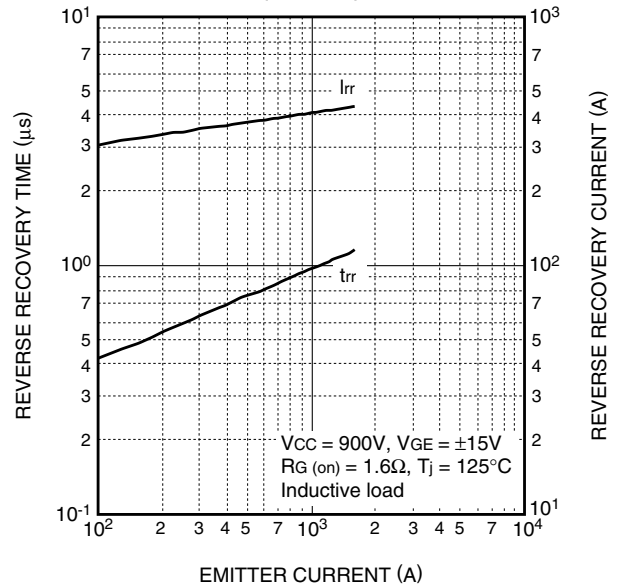

TRANSIENT THERMAL IMPEDANCE CHARACTERISTICS

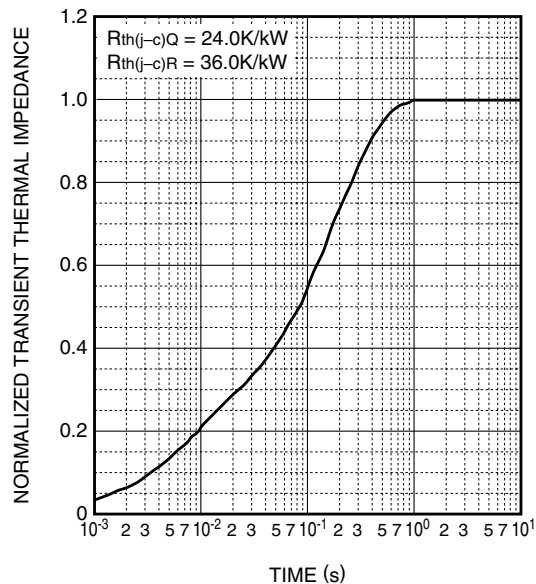

**CM800DZB-34N**

**HIGH POWER SWITCHING USE  
INSULATED TYPE**

4th-Version HVIGBT (High Voltage Insulated Gate Bipolar Transistor) Modules

