

# M63992FP

HIGH VOLTAGE HALF BRIDGE DRIVER

## DESCRIPTION

M63992FP is high voltage Power MOSFET and IGBT module driver for half bridge applications.

## FEATURES

- FLOATING SUPPLY VOLTAGE .....600V
- OUTPUT CURRENT .....±2A
- HALF BRIDGE DRIVER
- SOP-16

## APPLICATIONS

PDP, HID lamp.  
MOSFET and IGBT inverter module driver for refrigerator, air-conditioner, washing machine, AC-servomotor and general purpose.

## PIN CONFIGURATION (TOP VIEW)

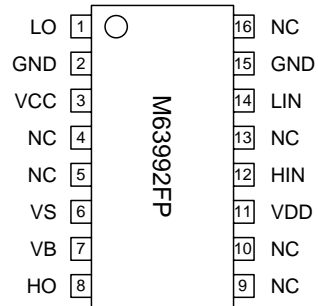

NC:NO CONNECTION

PACKAGE TYPE 16P2N

## BLOCK DIAGRAM

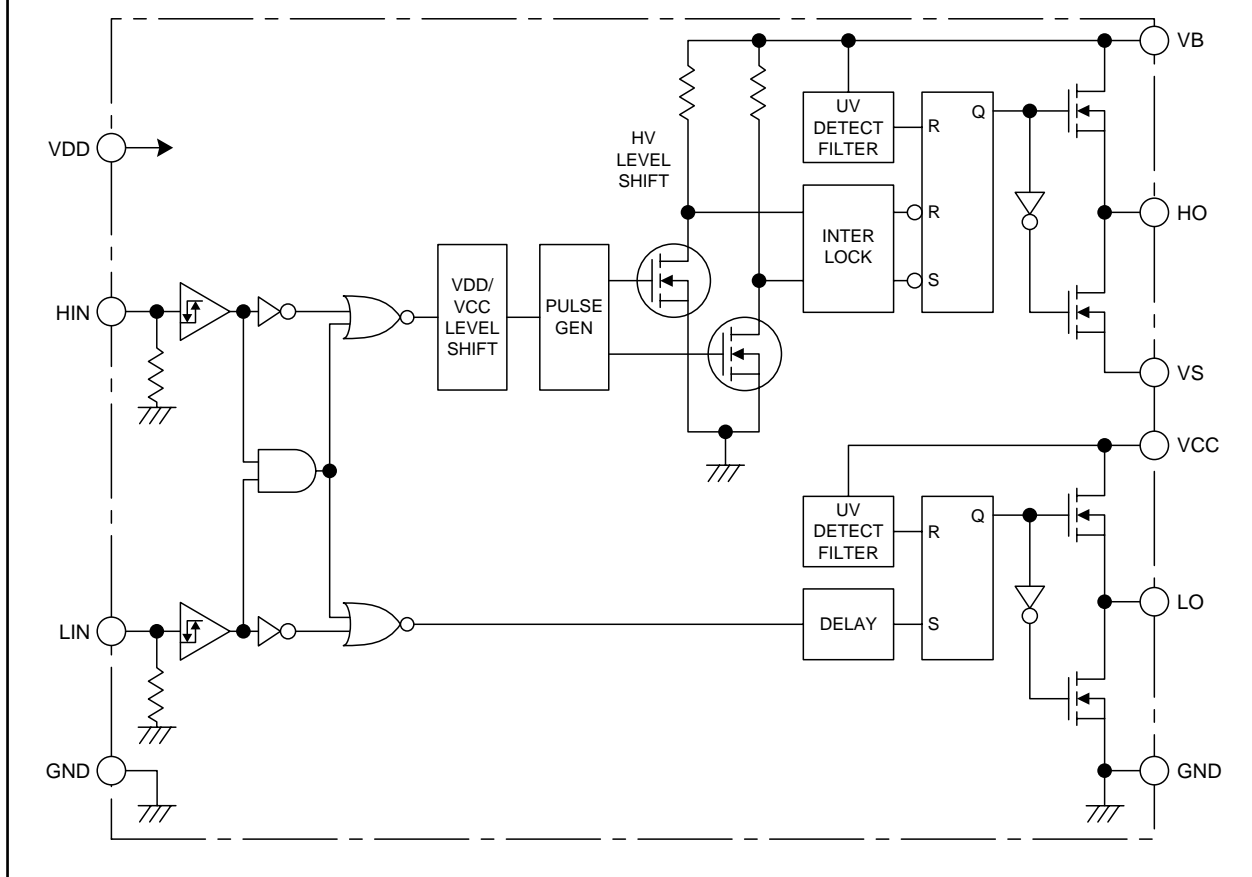

**ABSOLUTE MAXIMUM RATINGS**

Symbol	Parameter	Conditions	Ratings	Unit
VB	High Side Floating Supply Voltage		-0.5~624	V
VS	High Side Floating Supply Offset Voltage		VB-24 ~ VB+0.5	V
VHO	High Side Output Voltage		VS-0.5 ~ VB+0.5	V
VCC	Low Side Fixed Supply Voltage		-0.5 ~ 24	V
VLO	Low Side Output Voltage		-0.5 ~ VCC+0.5	V
VDD	Logic Supply Voltage		-0.5 ~ 7	V
VIN	Logic Input Voltage	HIN, LIN	-0.5 ~ VDD+0.5	V
dVS/dt	Allowable Offset Supply Voltage Transient		±50	V/ns
Rth(j-c)	Junction-Case Thermal Resistance		50	°C/W
Pt	Package Power Dissipation	Ta = 25°C, On Board	1.1	W
K θ	Linear Derating Factor	Ta > 25°C, On Board	11	mW/°C
Tj	Junction Temperature		-20 ~ 125	°C
Topr	Operation Temperature		-20 ~ 75	°C
Tstg	Storage Temperature		-40 ~ 125	°C

**RECOMMENDED OPERATING CONDITIONS**

Symbol	Parameter	Test Conditions	Limits			Unit
			Min.	Typ.	Max.	
VB	High Side Floating Supply Voltage		VS+13.5	—	VS+20	V
VS	High Side Floating Supply Offset Voltage		-5	—	500	V
VCC	Low Side Fixed Supply Voltage		13.5	—	20	V
VDD	Logic Supply Voltage		4.5	—	5.5	V
VIN	Logic Input Voltage	HIN, LIN	0	—	VDD	V

**FUNCTION TABLE**

HIN	LIN	VBS UV	VCC UV	HO	LO	Behavioral state
L	L	H	H	L	L	LO = OFF, HO = OFF
L	H	H	H	L	H	LO = ON, HO = OFF
H	L	H	H	H	L	LO = OFF, HO = ON
H	H	H	H	L	L	LO = OFF, HO = OFF, LIN = HIN = H simultaneously
X	L	L	H	L	L	LO = OFF, HO = OFF, VBS UV tripped
X	H	L	H	L	H	LO = ON, HO = OFF, VBS UV tripped
L	X	H	L	L <sup>(Note)</sup>	L	LO = OFF, HO = OFF, VCC UV tripped
H	X	H	L	H <sup>(Note)</sup>	L	LO = OFF, HO = ON, VCC UV tripped

Note : "L" state of VBS UV and VCC UV mean that UV trip voltage.  
 Even VCC UV is tripped, HO state is not changed.  
 When VCC is lower than UV trip voltage, HIN state can not be propagated to HO.

## HIGH VOLTAGE HALF BRIDGE DRIVER

## ELECTRICAL CHARACTERISTICS (Ta=25°C, VCC=VBS=15V, VDD=5V unless otherwise specified)

Symbol	Parameter	Test conditions	Limits			Unit
			Min.	Typ.	Max.	
IFS	Floating Supply Leakage Current	VB=VS=600V	—	—	1.0	μA
IBS	VBS standby Current		0.2	0.5	1.0	mA
ICC	VCC standby Current		0.2	0.5	1.0	mA
IDD	VDD standby Current		—	—	100	μA
VOH	High Level Output Voltage	IO=0A, LO, HO	13.8	14.4	—	V
VOL	Low Level Output Voltage	IO=0A, LO, HO	—	—	0.1	V
VIH	High Level Input Threshold Voltage	HIN, LIN	2.1	3.0	4.0	V
VIL	Low Level Input Threshold Voltage	HIN, LIN	0.6	1.5	1.9	V
IIH	High Level Input Bias Current	VIN=5V	—	25	75	μA
IIL	Low Level Input Bias Current	VIN=0V	—	—	1.0	μA
VBSUVT	VBS Supply UV Trip Voltage		9.5	10.5	11.5	V
VBSUVR	VBS Supply UV Reset Voltage		10.0	11.0	12.0	V
tVBSUV	VBS Supply UV Filter Time		—	7.5	—	μs
VCCUVT	VCC Supply UV Trip Voltage		9.5	10.5	11.5	V
VCCUVR	VCC Supply UV Reset Voltage		10.0	11.0	12.0	V
tVCCUV	VCC Supply UV Filter Time		—	7.5	—	μs
IOH	Output High Level Short Circuit Pulsed Current	VO=0V, VIN=5V, PW<10μs	—	-2.5	—	A
IOL	Output Low Level Short Circuit Pulsed Current	VO=15V, VIN=0V, PW<10μs	—	2.5	—	A
ROH	Output High Level On resistance	IO=-200mA, ROH=(VOH-VO)/IO	—	10	13	Ω
ROL	Output Low Level On resistance	IO=200mA, ROL=VO/IO	—	2.5	3.0	Ω
tdLH(HO)	High Side Turn-On Propagation Delay	CL=1000pF between HO – VS	250	300	350	ns
tdHL(HO)	High Side Turn-Off Propagation Delay	CL=1000pF between HO – VS	230	280	330	ns
tr(HO)	High Side Turn-On Rise Time	CL=1000pF between HO – VS	—	20	30	ns
tf(HO)	High Side Turn-Off Fall Time	CL=1000pF between HO – VS	—	15	25	ns
tdLH(LO)	Low Side Turn-On Propagation Delay	CL=1000pF between LO – GND	250	300	350	ns
tdHL(LO)	Low Side Turn-Off Propagation Delay	CL=1000pF between LO – GND	230	280	330	ns
tr(LO)	Low Side Turn-On Rise Time	CL=1000pF between LO – GND	—	20	30	ns
tf(LO)	Low Side Turn-Off Fall Time	CL=1000pF between LO – GND	—	15	25	ns
tdMon	Delay Matching, High Side and Low Side Turn-On	tdLH(HO)-tdLH(LO)	—	—	30	ns
tdMoff	Delay Matching, High Side and Low Side Turn-Off	tdHL(HO)-tdHL(LO)	—	—	30	ns

**LEAD DEFINITIONS**

Lead symbol	Description
LO	Low side gate drive output
GND	Ground
VCC	Low side supply
VS	High side floating supply (minus side)
VB	High side floating supply (plus side)
HO	High side gate drive output
VDD	Logic supply
HIN	Logic input for high side gate driver output (HO)
LIN	Logic input for low side gate driver output (LO)

**TIMING DIAGRAM**

1. Input/Output Timing Diagram

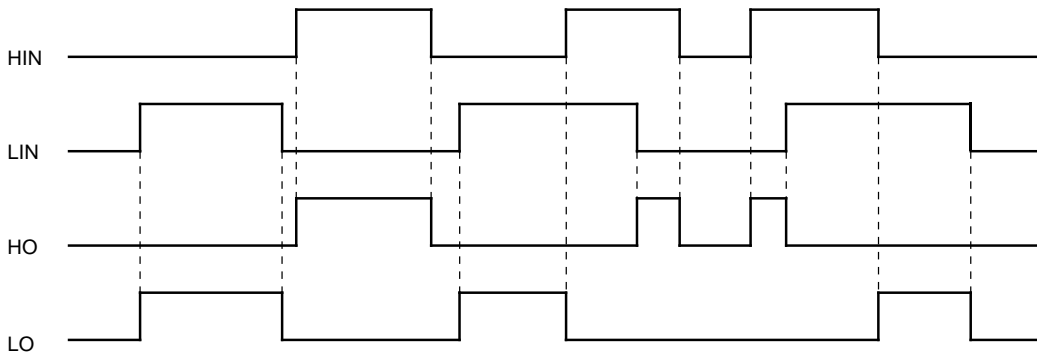

2. VCC(VBS) Supply Undervoltage Lockout Timing Diagram

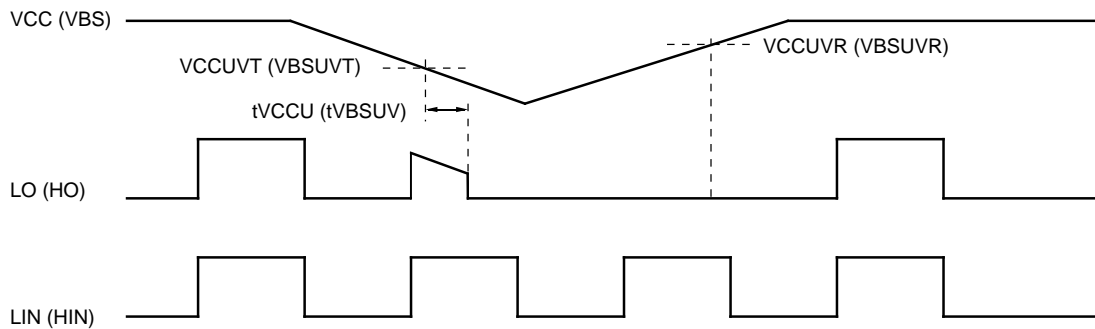

**PERFORMANCE CURVES**

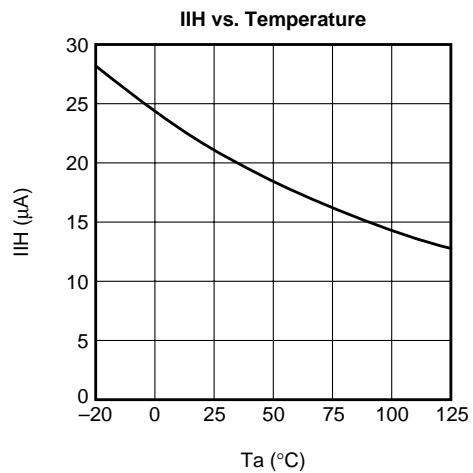
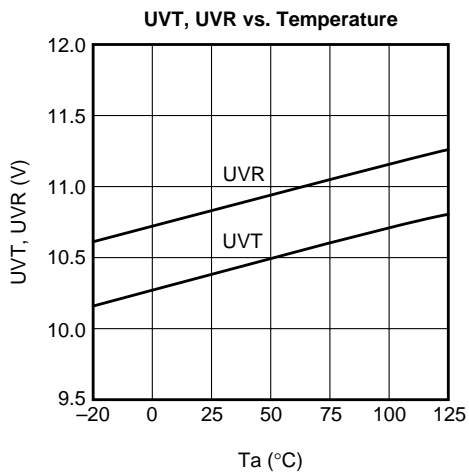
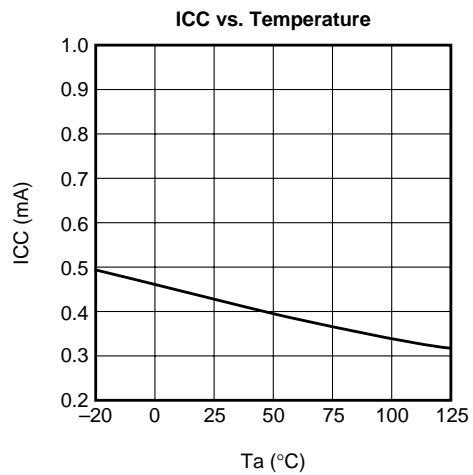
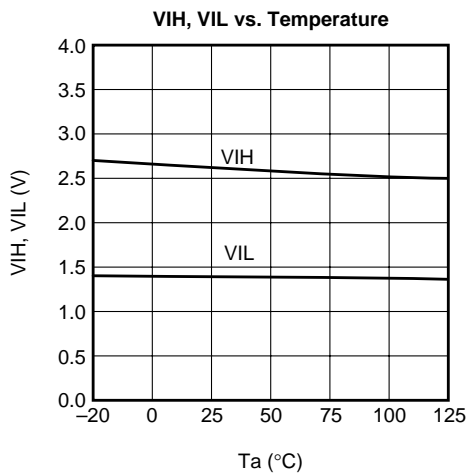
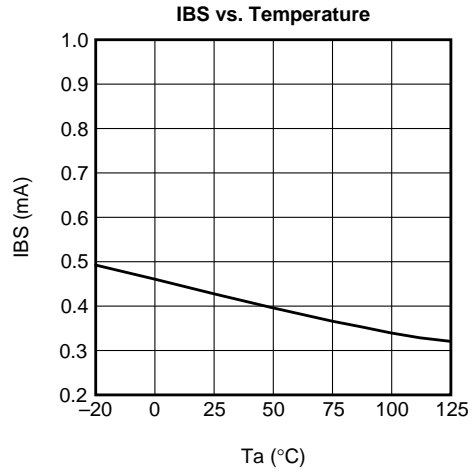
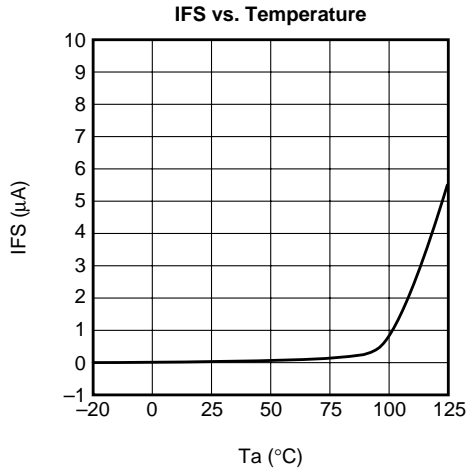

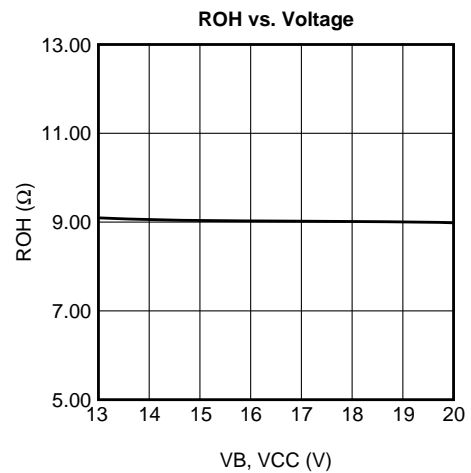
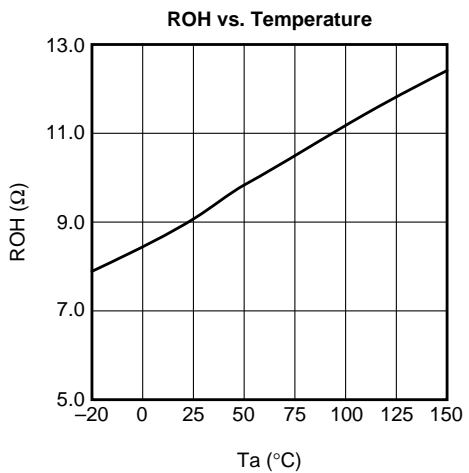
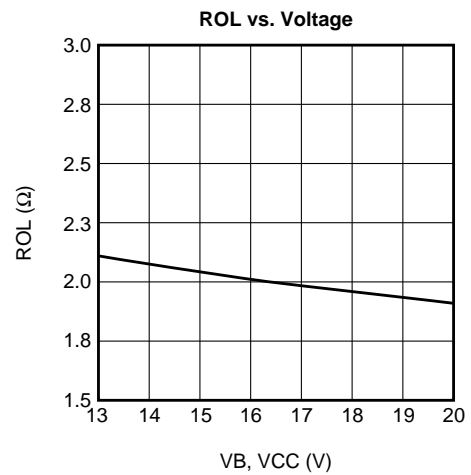
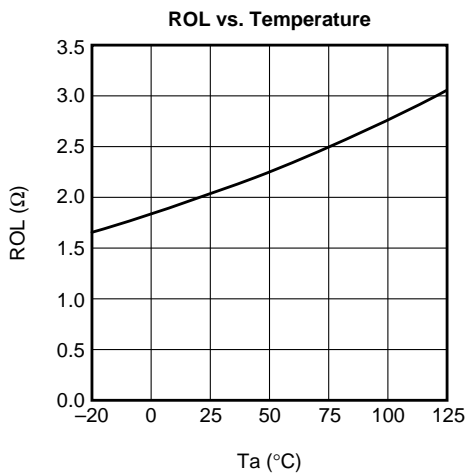
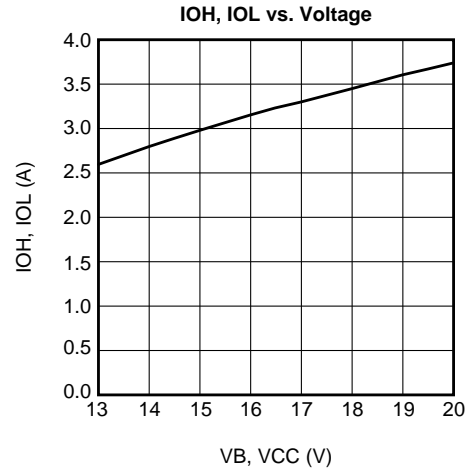
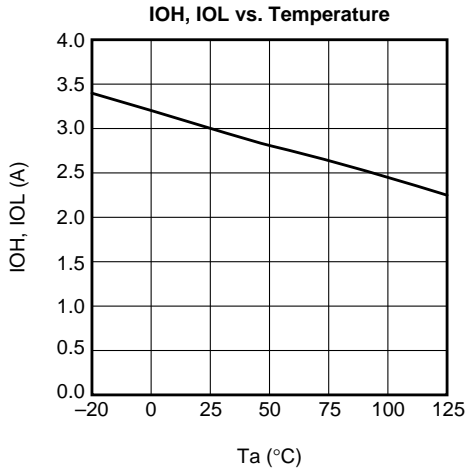

# M63992FP

## HIGH VOLTAGE HALF BRIDGE DRIVER

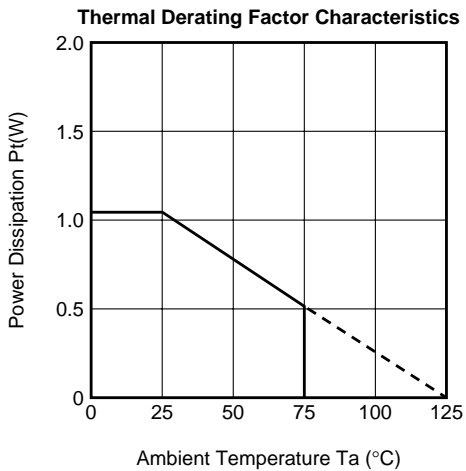
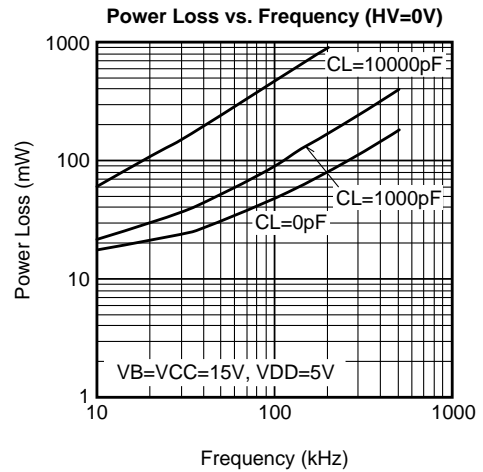
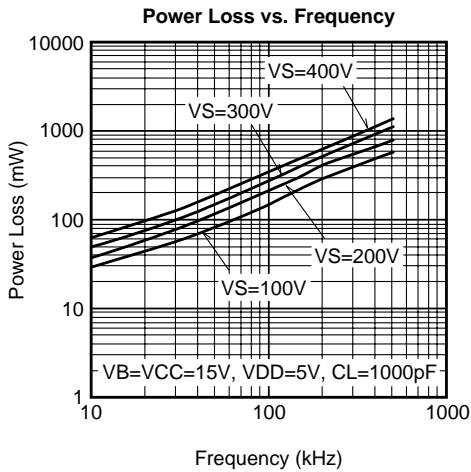
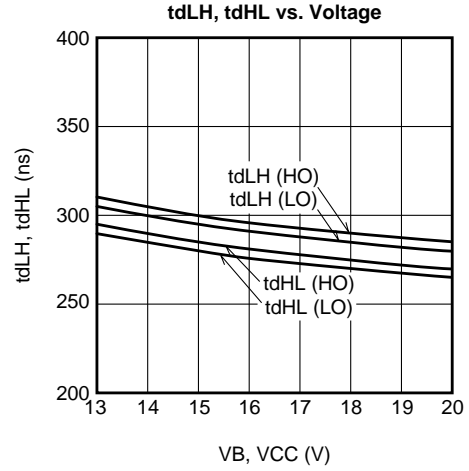
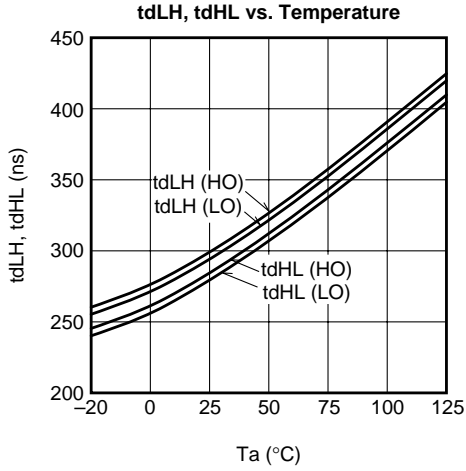

**M63992FP**

**HIGH VOLTAGE HALF BRIDGE DRIVER**

**PACKAGE OUTLINE**

**16P2N-A**

Plastic 16pin 300mil SOP

