

QH-26

3dB 90 Degree Hybrid Couplers

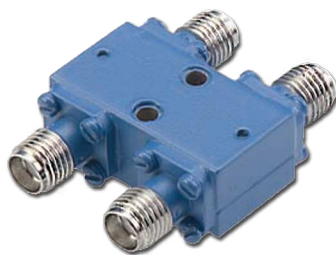

Specifications:

Parameter	Specification	Units
Frequency Range (Min)	0.25 – 0.5	GHz
Nominal Coupling	3.0 +.15/-0	dB
Deviation from Nominal Coupling (Max)	±.40	dB
Insertion Loss (Max)	0.15	dB
Isolation (Min)	22	dB
VSWR (Max)	1.15:1	Ratio
Phase Balance	±1.0	Degrees

"A" in.	"B" in.	"C" in.	"D" in.	"E" in.	"F" in.	"G" in.
1.65	1.15	0.82	-	0.95	0.25	-

Screening:

Internal Visual per MIL-STD-883, Method 2017
Temperature Cycle: -65 °C to +100 °C, 10 cycles

Hermetically-sealed switches are fine and gross leak checked per MIL-STD-883, Method 1014.

Optional High-Rel screening available upon request. Contact the factory to discuss your screening requirements.

Mechanical Specifications:

Case Style: QH Outline
Connectors: SMA Female per MIL-C-39012
Connector Control: Micro-D 21 Pin
Bias & Control Pins: ø0.02" x 0.15" long
Mounting: ø0.10" through holes (4) places

Environmental Specifications:

Designed to meet:

MIL-E-5400, MIL-STD-202, MIL-E-16400

Operating Temp: -55°C to +125°C

Storage Temp: -65°C to +150°C

Humidity: MIL-STD-202F, M103, Cond B

Shock: MIL-STD-202F, M213, Cond B

Altitude: MIL-STD-202F, M105, Cond B

Vibration: MIL-STD-202F, M204, Cond B

Thermal Shock: MIL-STD-202F, M107, Cond A

Temperature Cycle: MIL-STD-202F, M105C, Cond D

Custom Options – Contact the Factory

- Gray epoxy paint per MIL-C-22750
- Video transient suppression
- GPO connectors
- ECL logic input
- Phase and amplitude tracking
- Other frequency ranges available from 1MHz to 26GHz
- Reversed logic
- Available without SMA connectors for drop-in applications
- High rel screening



40 Industrial Way East, Eatontown, NJ 07724 [USA]
Phone: (732) 460-0212, Fax: (732) 460-0214
www.aeroflex.com/acc, email: acc-sales@eroflex.com

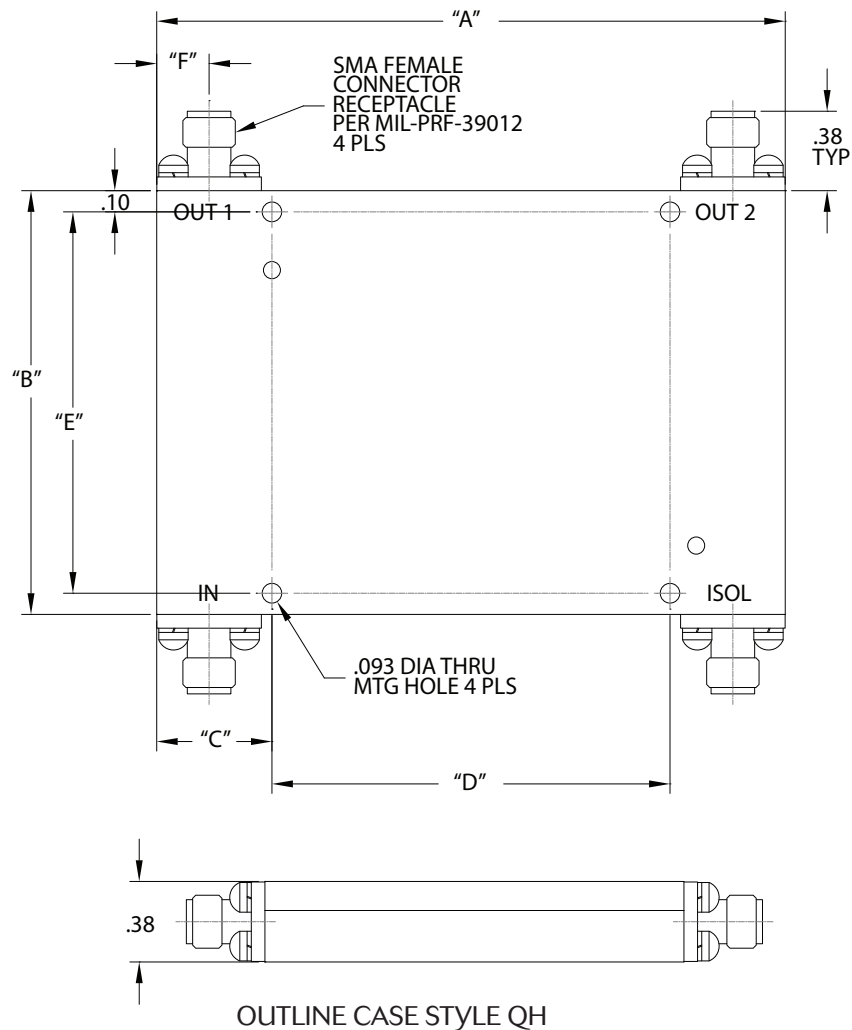

Aeroflex Control Components
Aeroflex Microelectronic Solutions
40 Industrial Way East
Eatontown, NJ 07724 [USA]
Fax: (732) 460-0214

Sales
Phone: (732) 460-0212
ACC-sales@aeroflex.com

www.aeroflex.com/Microwave www.aeroflex.com/ACC

Aeroflex Control Components reserves the right to make changes to any products and services herein at any time without notice. Consult Aeroflex or an authorized sales representative to verify that the information in this data sheet is current before using this product. Aeroflex does not assume any responsibility or liability arising out of the application or use of any product or service described herein, except as expressly agreed to in writing by Aeroflex; nor does the purchase, lease, or use of a product or service from Aeroflex convey a license under any patent rights, copyrights, trademark rights, or any other of the intellectual rights of Aeroflex or of third parties.

Copyright 2011 Aeroflex Control Components. All rights reserved.

ISO 9001:2008 certified



Our passion for performance is defined by three attributes represented by these three icons: solution-minded, performance-driven and customer-focused.