

YT-89

3 Way In-Phase Power Divider / Combiner

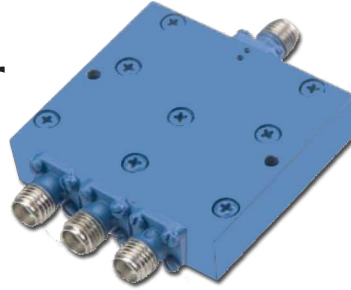

Specifications:

Parameter	Specification	Units
Frequency Range (Min)	8.4 – 9.7	GHz
In / Out VSWR (Max)	1.40 / 1.35	dB
Insertion Loss (Max)	0.50	dB
Isolation (Min)	17.0	dB
Phase Balance	4.0	Degrees
Amp Balance	0.30	dB

Environmental Specifications:

Designed to meet:

MIL-E-5400, MIL-STD-202, MIL-E-16400

Operating Temp: -55°C to +125°C

Storage Temp: -65°C to +150°C

Humidity: MIL-STD-202F, M103, Cond B

Shock: MIL-STD-202F, M213, Cond B

Altitude: MIL-STD-202F, M105, Cond B

Vibration: MIL-STD-202F, M204, Cond B

Thermal Shock: MIL-STD-202F, M107, Cond A

Temperature Cycle: MIL-STD-202F, M105C, Cond D

Notes:

Please Contact the Factory for Custom Specifications

Mechanical Specifications:

Case Style: YT Outline

Connectors: SMA Female per MIL-C-39012

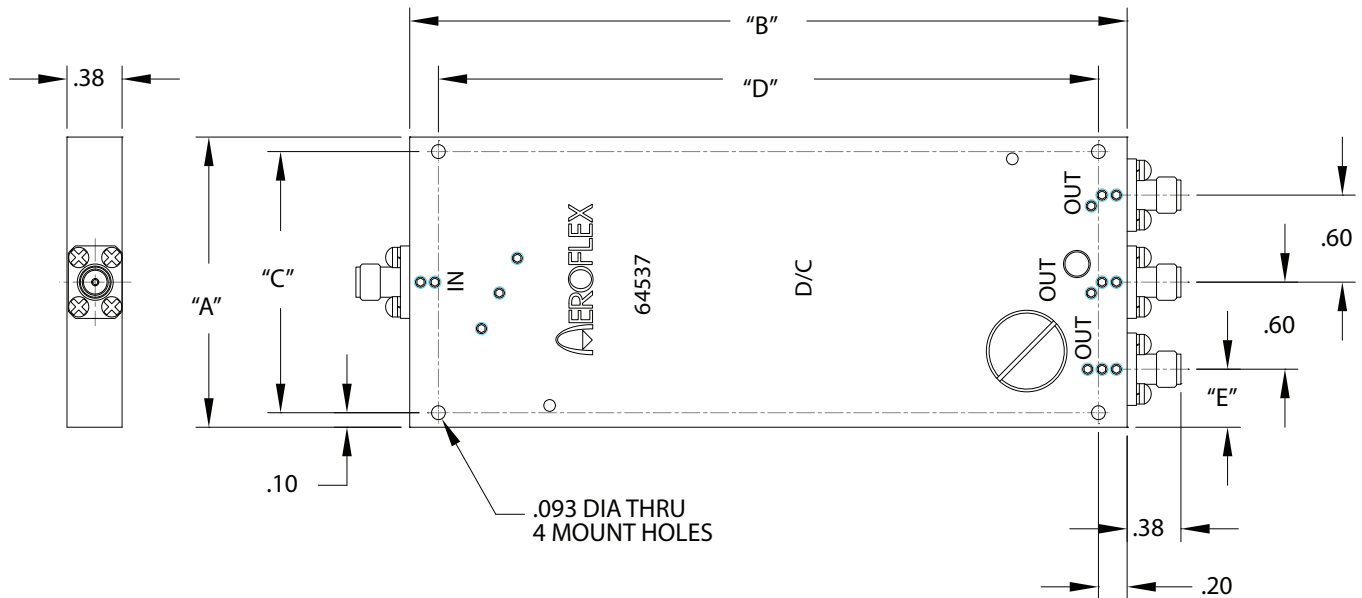

OUTLINE CASE STYLE YT

"A" in	"B" in	"C" in	"D" in	"E" in
1.75	1.5	1.55	1.10	0.38

Aeroflex Control Components
Aeroflex Microelectronic Solutions
40 Industrial Way East
Eatontown, NJ 07724 [USA]
Fax: (732) 460-0214

Sales
Phone: (732) 460-0212
ACC-sales@aeroflex.com

www.aeroflex.com/Microwave www.aeroflex.com/ACC

Aeroflex Control Components reserves the right to make changes to any products and services herein at any time without notice. Consult Aeroflex or an authorized sales representative to verify that the information in this data sheet is current before using this product. Aeroflex does not assume any responsibility or liability arising out of the application or use of any product or service described herein, except as expressly agreed to in writing by Aeroflex; nor does the purchase, lease, or use of a product or service from Aeroflex convey a license under any patent rights, copyrights, trademark rights, or any other of the intellectual rights of Aeroflex or of third parties.

Copyright 2011 Aeroflex Control Components. All rights reserved.

ISO 9001:2008 certified



Our passion for performance is defined by three attributes represented by these three icons: solution-minded, performance-driven and customer-focused.