

DATA SHEET

SKY13372-467LF: 0.1-6.0 GHz High Isolation SPDT Absorptive Switch

Applications

- GSM, PCS, WCDMA base stations
- 2.4 and 5.8 GHz ISM devices
- Wireless local loops

Features

- Single, positive voltage control: 0 to 3 and 0 to 5 V
- High isolation 64 dB at 1 GHz and 2 GHz
- Integrated silicon CMOS driver
- Absorptive
- Small, QFN (16-pin, 4 x 4 mm) Pb-free package (MSL1, 260 °C per JEDEC J-STD-020)



Skyworks Pb-free products are compliant with all applicable legislation. For additional information, refer to *Skyworks Definition of Lead (Pb)-Free*, document number SQ04-0073.

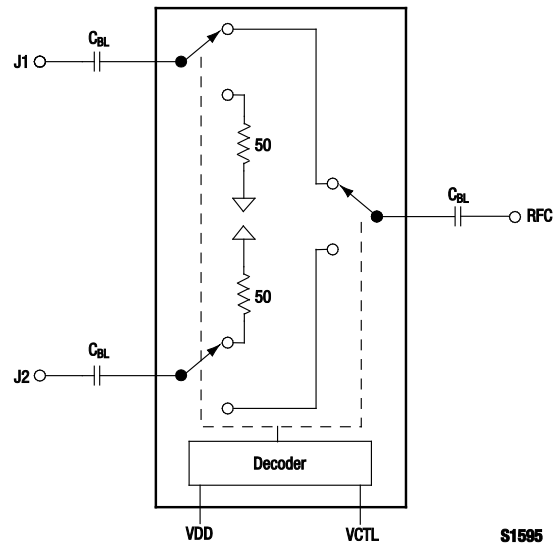

Figure 1. SKY13372-467LF Block Diagram

Description

The SKY13372-467LF is a GaAs pHEMT FET high-isolation, absorptive switch. The device is an ideal component for base station applications in which synthesizer isolation is critical.

The device is provided in a 4 x 4 mm, 16-pin Quad Flat No-Lead (QFN) package. A functional block diagram is shown in Figure 1. The pin configuration and package are shown in Figure 2. Signal pin assignments and functional pin descriptions are provided in Table 1.

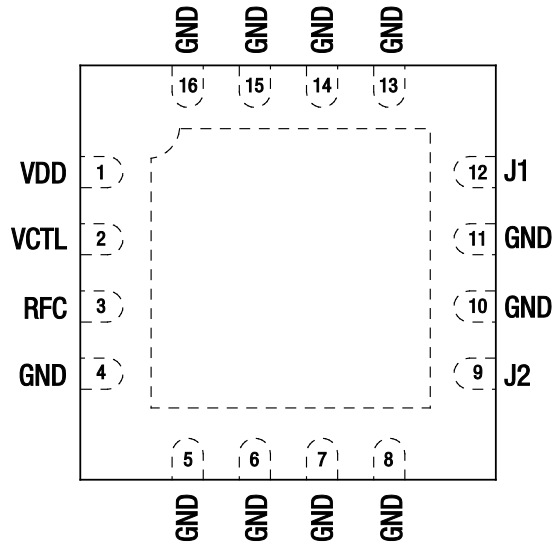

Figure 2. SKY13372-467LF Pinout – 16-Pin QFN (Top View)

Table 1. SKY13372-467LF Signal Descriptions

Pin #	Name	Description	Pin #	Name	Description
1	VDD	DC power supply	9	J2	RF output 2. Must be DC blocked.
2	VCTL	DC switch control pin. Switches insertion loss state from RFC to J1 or J2 (see Table 5).	10	GND	Ground
3	RFC	RF input. Must be DC blocked.	11	GND	Ground
4	GND	Ground	12	J1	RF output 1. Must be DC blocked.
5	GND	Ground	13	GND	Ground
6	GND	Ground	14	GND	Ground
7	GND	Ground	15	GND	Ground
8	GND	Ground	16	GND	Ground

Note: Exposed pad on bottom of package must be grounded.

Electrical and Mechanical Specifications

The absolute maximum ratings of the SKY13372-467LF are provided in Table 2. Electrical specifications are provided in Table 3.

Typical performance characteristics of the SKY13372-467LF are illustrated in Figures 3 through 7.

The state of the SKY13372-467LF is determined by the logic provided in Table 4.

Table 2. SKY13372-467LF Absolute Maximum Ratings

Parameter	Symbol	Minimum	Typical	Maximum	Units
Supply voltage	V _{DD}	2.7		5.5	V
RF input power @ >500 MHz	V _I		1		W
Operating temperature	T _{OP}	-40		+95	°C
Storage temperature	T _{STG}	-65		+150	°C

Note: Exposure to maximum rating conditions for extended periods may reduce device reliability. There is no damage to device with only one parameter set at the limit and all other parameters set at or below their nominal value. Exceeding any of the limits listed here may result in permanent damage to the device.

CAUTION: Although this device is designed to be as robust as possible, Electrostatic Discharge (ESD) can damage this device. This device must be protected at all times from ESD. Static charges may easily produce potentials of several kilovolts on the human body or equipment, which can discharge without detection. Industry-standard ESD precautions should be used at all times.

Table 3. SKY13372-467LF Electrical Specifications (Note 1)

(V_{CTL} = 0 V/3 V, V_{DD} = 3 V, T_{OP} = +25 °C, P_{IN} = 0 dBm, Characteristic Impedance [Z₀] = 50 Ω, Unless Otherwise Noted)

Parameter	Symbol	Test Condition	Min	Typical	Max	Units
RF Specifications						
Insertion loss	IL	0.1 to 2.0 GHz		0.8	1.1	dB
		2.0 to 3.0 GHz		0.9	1.2	dB
		3.0 to 4.0 GHz		1.0	1.3	dB
		4.0 to 6.0 GHz		1.7	1.9	dB
Isolation	Iso	0.1 to 2.0 GHz	56	65		dB
		2.0 to 3.0 GHz	53	60		dB
		3.0 to 4.0 GHz	50	55		dB
		4.0 to 6.0 GHz	40	42		dB
Return loss (insertion loss state)	RL	0.1 to 2.0 GHz		22		dB
		2.0 to 3.0 GHz		22		dB
		3.0 to 4.0 GHz		17		dB
		4.0 to 6.0 GHz		15		dB
Return loss (isolation state)	RL	0.5 to 2.0 GHz		10		dB
		2.0 to 3.0 GHz		25		dB
		3.0 to 4.0 GHz		18		dB
		4.0 to 6.0 GHz		13		dB
1 dB Input Compression Point	IP1dB	0.7 to 2.0 GHz		+26		dBm
3 rd Order Input Intercept Point	IIP3	@ 900 MHz, Δf = 1 MHz, P _{IN} = +7 dBm/tone		+45		dBm
Switching rise time	T _{RISE}	10% to 90% RF		40		ns
Switching fall time	T _{FALL}	90% to 10% RF		40		ns
Switching on time	T _{ON}	50% V _{CTL} to 90% RF		100		ns
Switching off time	T _{OFF}	50% V _{CTL} to 10% RF		100		ns
DC Specifications						
Control voltage: low high	V _{CTL}		0		0.3 × V _{DD}	V
			0.7 × V _{DD}		V _{DD}	V
Control current	I _{CTL}				5	μA
Supply voltage	V _{DD}		2.7		5.0	V
Supply current	I _{DD}				100	μA

Note 1: Performance is guaranteed only under the conditions listed in this Table.

Typical Performance Characteristics

(VCTL = 0 V/3 V, VDD = 3 V, T_{OP} = +25 °C, P_{IN} = 0 dBm, Characteristic Impedance [Z₀] = 50 Ω, Unless Otherwise Noted)

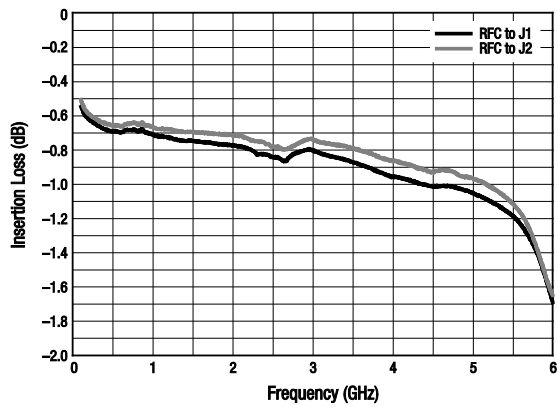

Figure 3. Insertion Loss vs Frequency

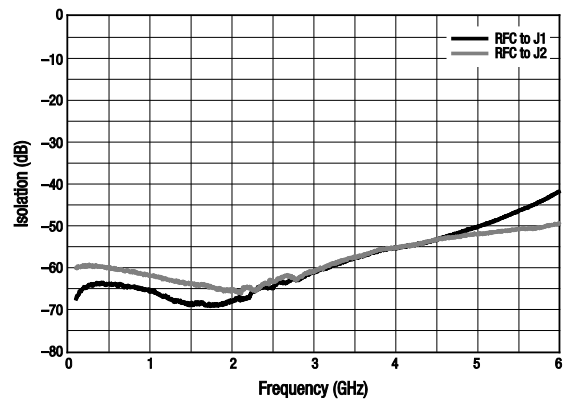

Figure 4. Isolation vs Frequency

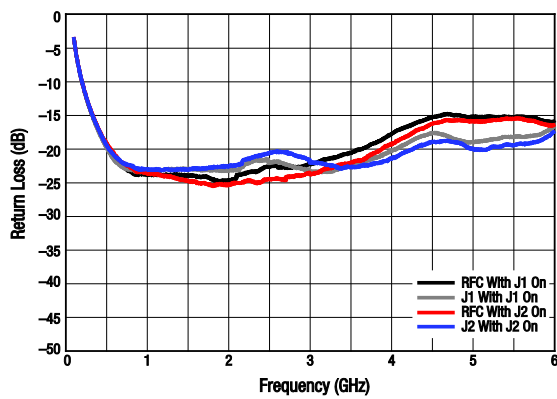

Figure 5. Return Loss vs Frequency (Insertion Loss State)

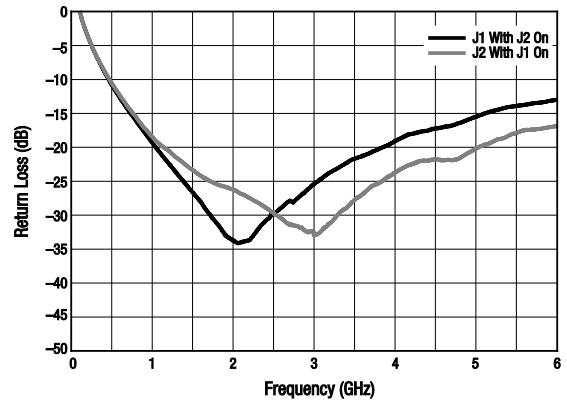

Figure 6. Return Loss vs Frequency (Isolation State)

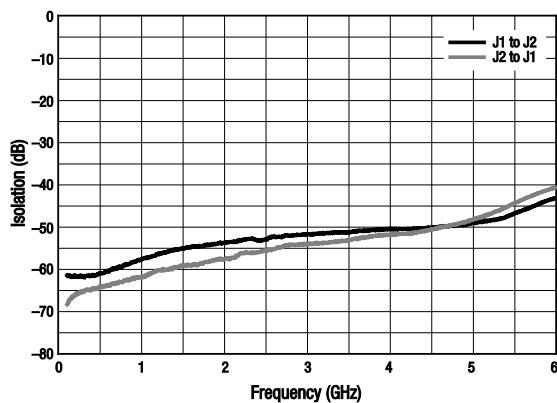

Figure 7. Output to Output Isolation vs Frequency

Table 4. SKY13372-467LF Truth Table

VCTL	RFC to J1	RFC to J2
0	Insertion loss	Isolation
1	Isolation	Insertion loss

Evaluation Board Description

The SKY13372-467LF Evaluation Board is used to test the performance of the SKY13372-467LF SPDT absorptive switch. An assembly drawing for the Evaluation Board is shown in Figure 8.

Package Dimensions

The PCB layout footprint for the SKY13372-467LF is shown in Figure 9. Typical case markings are noted in Figure 10. Package dimensions for the 16-pin QFN are shown in Figure 13, and tape and reel dimensions are provided in Figure 12.

Package and Handling Information

Instructions on the shipping container label regarding exposure to moisture after the container seal is broken must be followed. Otherwise, problems related to moisture absorption may occur when the part is subjected to high temperature during solder assembly.

THE SKY13372-467LF is rated to Moisture Sensivity Level 1 (MSL1) at 260 °C. It can be used for lead or lead-free soldering. For additional information, refer to the Skyworks Application Note, *Solder Reflow Information*, document number 200164.

Care must be taken when attaching this product, whether it is done manually or in a production solder reflow environment. Production quantities of this product are shipped in a standard tape and reel format.

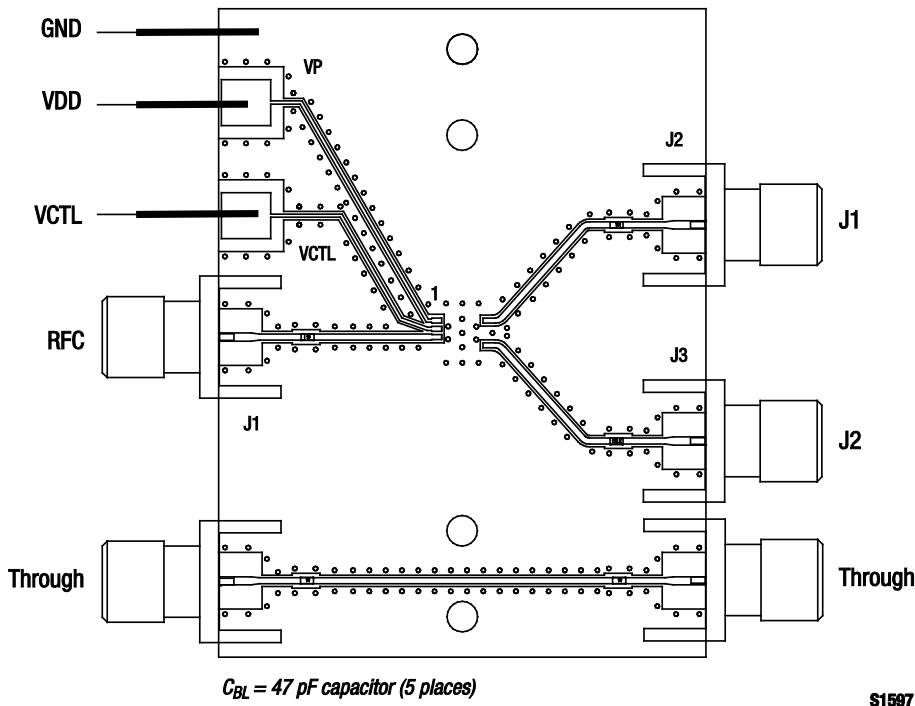

Figure 8. SKY13372-467LF Evaluation Board Assembly Diagram

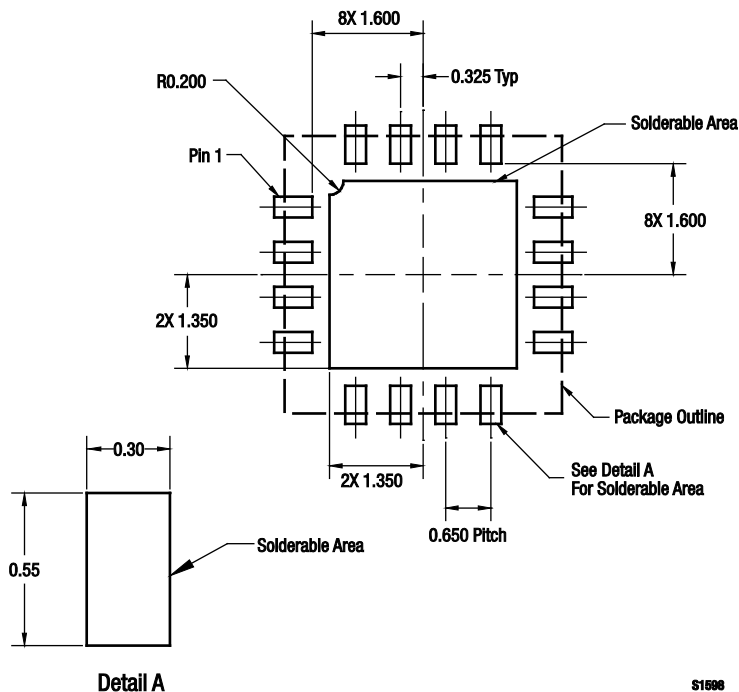

Figure 9. SKY13372-467LF PCB Layout Footprint

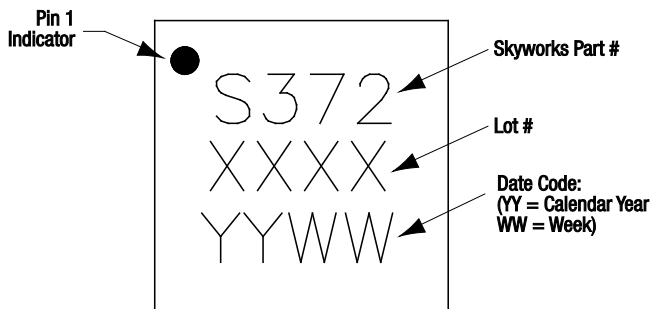
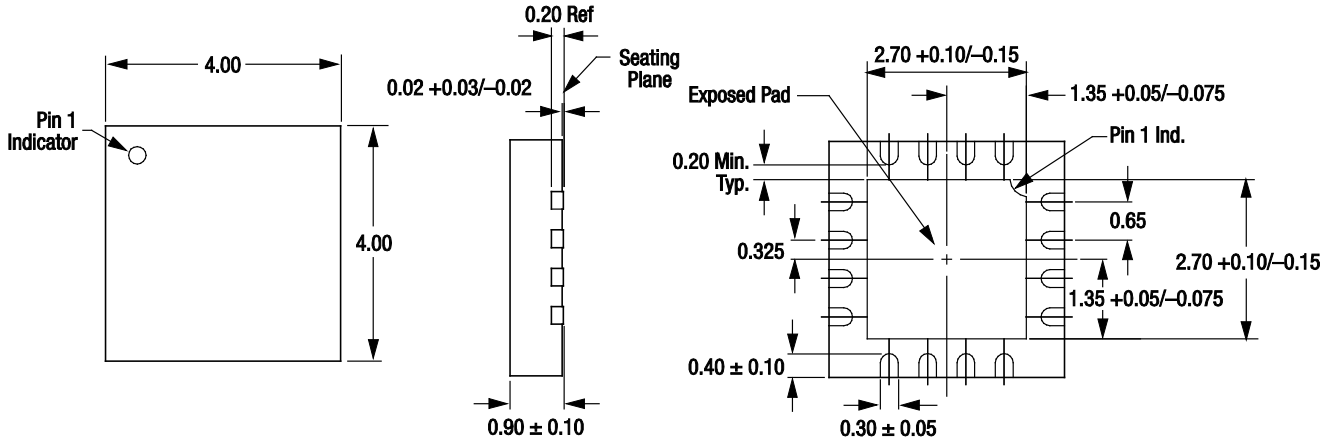

Figure 10. Typical Case Markings



All dimensions are in millimeters

S1596

Figure 11. SKY13372-467LF 16-Pin QFN Package Dimensions

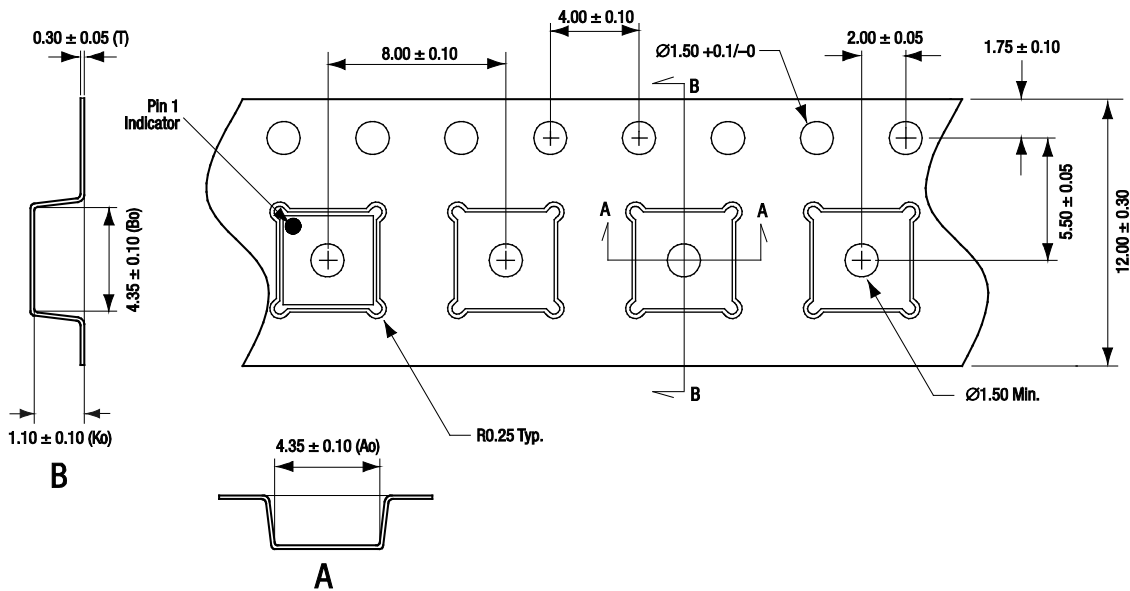

Notes:

1. Carrier tape material: black conductive polystyrene, non-bakeable
2. Cover tape material: transparent conductive HSA
3. Cover tape size: 9.2 mm width
4. ESD surface resistivity is $\geq 1 \times 10^2 \sim \leq 1 \times 10^{10}$ Ohms/square per EIA, JEDEC TNR Specification.
5. All measurements are in millimeters

S1846

Figure 12. SKY13372-467LF Tape and Reel Dimensions

Ordering Information

Model Name	Manufacturing Part Number	Evaluation Board Part Number
SKY13372-467LF SPDT Absorptive Switch	SKY13372-467LF	SKY13372-467LF-EVB

Copyright © 2011, 2012 Skyworks Solutions, Inc. All Rights Reserved.

Information in this document is provided in connection with Skyworks Solutions, Inc. (“Skyworks”) products or services. These materials, including the information contained herein, are provided by Skyworks as a service to its customers and may be used for informational purposes only by the customer. Skyworks assumes no responsibility for errors or omissions in these materials or the information contained herein. Skyworks may change its documentation, products, services, specifications or product descriptions at any time, without notice. Skyworks makes no commitment to update the materials or information and shall have no responsibility whatsoever for conflicts, incompatibilities, or other difficulties arising from any future changes.

No license, whether express, implied, by estoppel or otherwise, is granted to any intellectual property rights by this document. Skyworks assumes no liability for any materials, products or information provided hereunder, including the sale, distribution, reproduction or use of Skyworks products, information or materials, except as may be provided in Skyworks Terms and Conditions of Sale.

THE MATERIALS, PRODUCTS AND INFORMATION ARE PROVIDED “AS IS” WITHOUT WARRANTY OF ANY KIND, WHETHER EXPRESS, IMPLIED, STATUTORY, OR OTHERWISE, INCLUDING FITNESS FOR A PARTICULAR PURPOSE OR USE, MERCHANTABILITY, PERFORMANCE, QUALITY OR NON-INFRINGEMENT OF ANY INTELLECTUAL PROPERTY RIGHT; ALL SUCH WARRANTIES ARE HEREBY EXPRESSLY DISCLAIMED. SKYWORKS DOES NOT WARRANT THE ACCURACY OR COMPLETENESS OF THE INFORMATION, TEXT, GRAPHICS OR OTHER ITEMS CONTAINED WITHIN THESE MATERIALS. SKYWORKS SHALL NOT BE LIABLE FOR ANY DAMAGES, INCLUDING BUT NOT LIMITED TO ANY SPECIAL, INDIRECT, INCIDENTAL, STATUTORY, OR CONSEQUENTIAL DAMAGES, INCLUDING WITHOUT LIMITATION, LOST REVENUES OR LOST PROFITS THAT MAY RESULT FROM THE USE OF THE MATERIALS OR INFORMATION, WHETHER OR NOT THE RECIPIENT OF MATERIALS HAS BEEN ADVISED OF THE POSSIBILITY OF SUCH DAMAGE.

Skyworks products are not intended for use in medical, lifesaving or life-sustaining applications, or other equipment in which the failure of the Skyworks products could lead to personal injury, death, physical or environmental damage. Skyworks customers using or selling Skyworks products for use in such applications do so at their own risk and agree to fully indemnify Skyworks for any damages resulting from such improper use or sale.

Customers are responsible for their products and applications using Skyworks products, which may deviate from published specifications as a result of design defects, errors, or operation of products outside of published parameters or design specifications. Customers should include design and operating safeguards to minimize these and other risks. Skyworks assumes no liability for applications assistance, customer product design, or damage to any equipment resulting from the use of Skyworks products outside of stated published specifications or parameters.

Skyworks, the Skyworks symbol, and “Breakthrough Simplicity” are trademarks or registered trademarks of Skyworks Solutions, Inc., in the United States and other countries. Third-party brands and names are for identification purposes only, and are the property of their respective owners. Additional information, including relevant terms and conditions, posted at www.skyworksinc.com, are incorporated by reference.