

Part Number: SC23-12SEKWA

Super Bright Orange

### Features

- 2.3 inch digit height.
- Low current operation.
- Excellent character appearance.
- High light output.
- Easy mounting on P.C. boards or sockets.
- Multicolor available.
- Mechanically rugged.
- Standard : gray face, white segment.
- RoHS compliant.

### Description

The Super Bright Orange device is made with AlGaInP (on GaAs substrate) light emitting diode chip.

### Package Dimensions & Internal Circuit Diagram

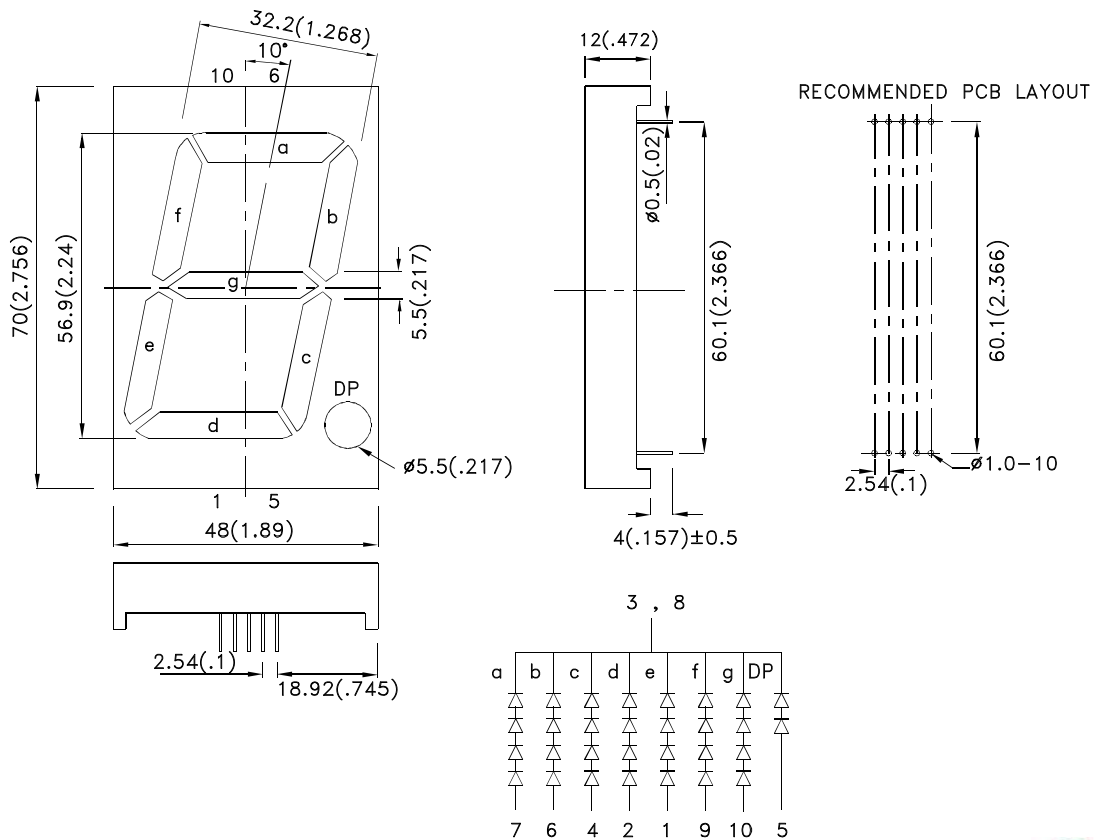

#### Notes:

1. All dimensions are in millimeters (inches), Tolerance is  $\pm 0.25(0.01)$  unless otherwise noted.
2. The specifications, characteristics and technical data described in the datasheet are subject to change without prior notice.



## Selection Guide

Part No.	Dice	Lens Type	Iv (ucd) [1] @ 10mA		Description
			Min.	Typ.	
SC23-12SEKWA	Super Bright Orange (AlGaInP)	White Diffused	88000	310000	Common Cathode,Rt. Hand Decimal.

Note:

1. Luminous Intensity / Luminous Flux: +/-15%.

## Electrical / Optical Characteristics at TA=25°C

Symbol	Parameter	Device	Typ.	Max.	Units	Test Conditions
$\lambda_{peak}$	Peak Wavelength	Super Bright Orange	610		nm	IF=20mA
$\lambda_D$ [1]	Dominant Wavelength	Super Bright Orange	601		nm	IF=20mA
$\Delta\lambda/2$	Spectral Line Half-width	Super Bright Orange	29		nm	IF=20mA
C	Capacitance	Super Bright Orange	15		pF	VF=0V;f=1MHz
VF [2]	Forward Voltage Per Segment Or (DP)	Super Bright Orange	8.4 (4.2)	10 (5.0)	V	IF=20mA
IR	Reverse Current Per Segment Or (DP)	Super Bright Orange		10 (10)	uA	VR = 5V (VR = 5V)

Notes:

1. Wavelength: +/-1nm.
2. Forward Voltage: +/-0.1V.

## Absolute Maximum Ratings at TA=25°C

Parameter	Super Bright Orange	Units
Power dissipation Per Segment Or (DP)	300 (150)	mW
DC Forward Current Per Segment Or (DP)	30 (30)	mA
Peak Forward Current [1] Per Segment Or (DP)	195 (195)	mA
Reverse Voltage Per Segment Or (DP)	5 (5)	V
Operating/Storage Temperature	-40°C To +85°C	
Lead Solder Temperature [2]	260°C For 3~ 5 Seconds	

Notes:

1. 1/10 Duty Cycle, 0.1ms Pulse Width.
2. 2mm below package base.



## Super Bright Orange

## SC23-12SEKWA

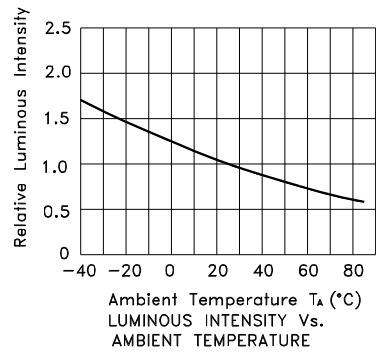
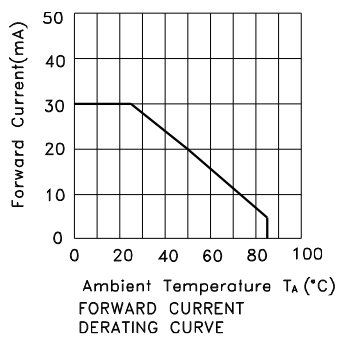
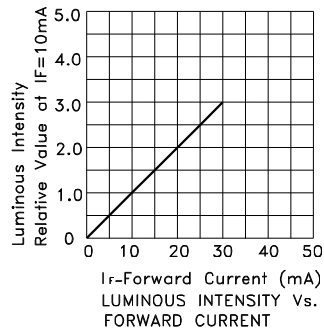
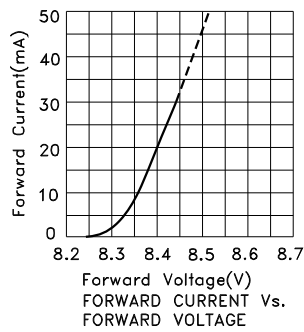

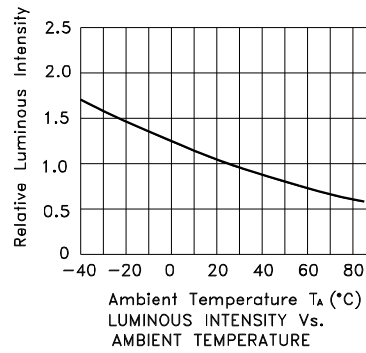
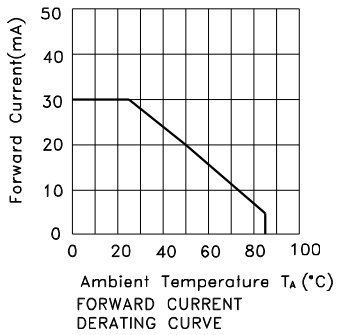
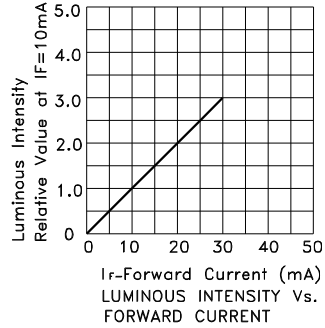
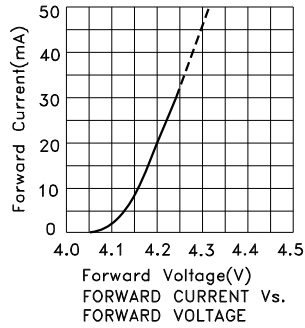

**PACKING & LABEL SPECIFICATIONS**

**SC23-12SEKWA**

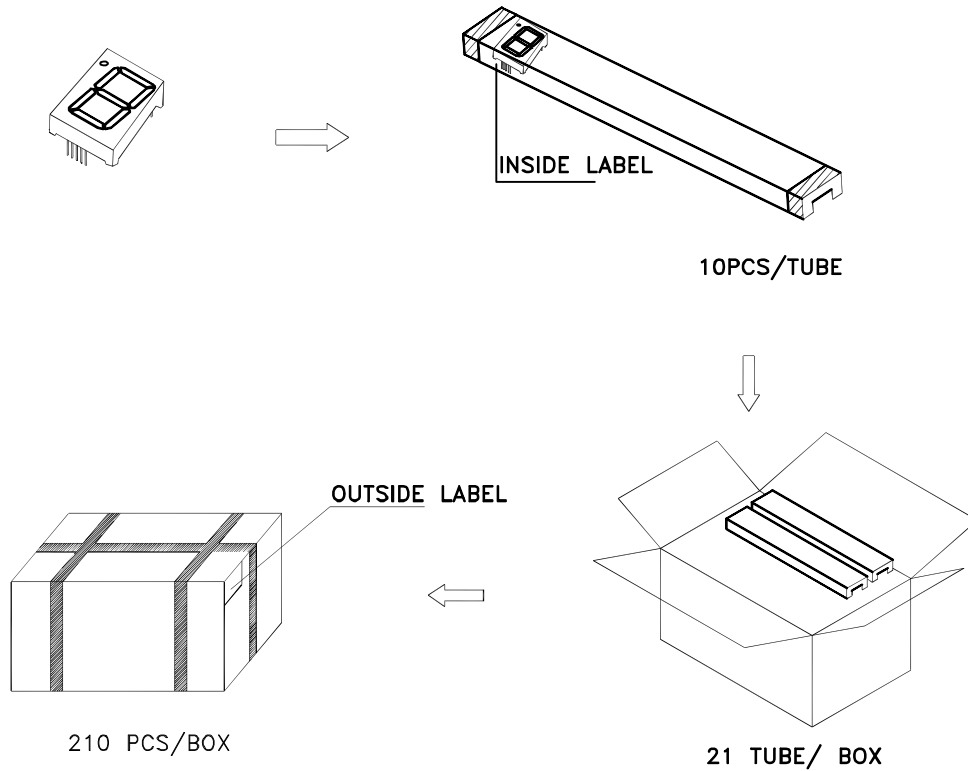

Inside Label On IC-tube

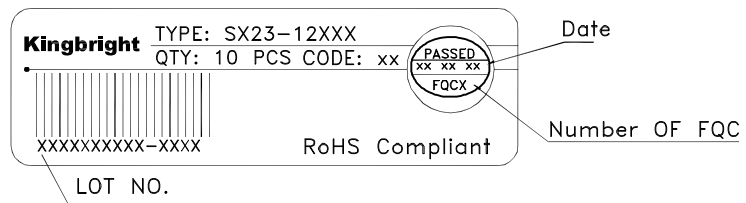

Outside Label On Box

