

Features

- 0.25 inch digit height
- Low current operation.
- Excellent character appearance.
- Easy mounting on P.C. boards or sockets.
- Categorized for luminous intensity.
- Mechanically rugged.
- Standard : gray face, white segment.
- RoHS compliant.

Description

The Green source color devices are made with AlGaInP on GaAs substrate Light Emitting Diode.

Package Dimensions & Internal Circuit Diagram

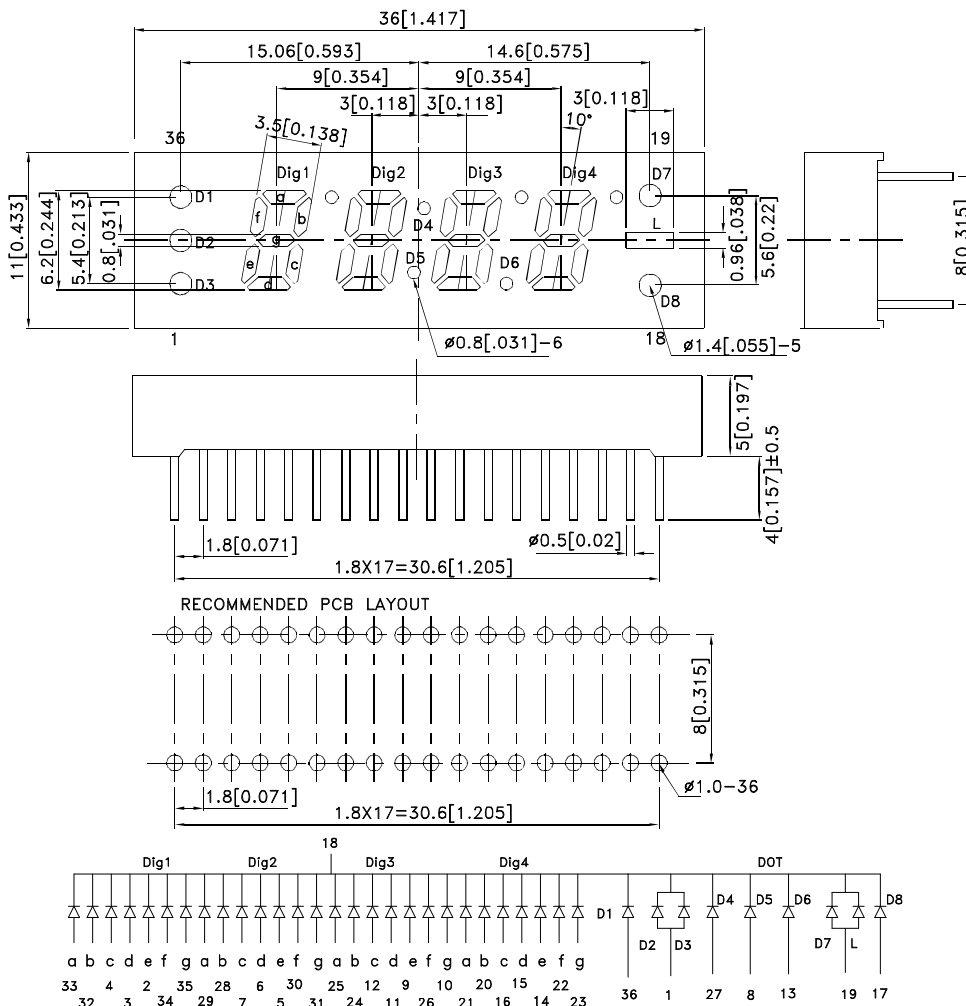

Notes:

1. All dimensions are in millimeters (inches), Tolerance is $\pm 0.25 (0.01)$ unless otherwise noted.
2. The specifications, characteristics and technical data described in the datasheet are subject to change without prior notice.



Selection Guide

Part No.	Dice	Lens Type	Iv (ucd) [1] @ 10mA		Description
			Min.	Typ.	
CC25-11CGKWA	Green (AlGaInP)	WHITE DIFFUSED	14000	34000	Common Cathode

Note:

- Luminous intensity/ luminous Flux: +/-15%.

Electrical / Optical Characteristics at TA=25°C

Symbol	Parameter		Device	Typ.	Max.	Units	Test Conditions
λ peak	Peak Wavelength		Green	574		nm	IF=20mA
λ D [1]	Dominant Wavelength		Green	570		nm	IF=20mA
$\Delta\lambda$ 1/2	Spectral Line Half-width		Green	20		nm	IF=20mA
C	Capacitance		Green	15		pF	VF=0V;f=1MHz
VF [2]	Forward Voltage	Dig1'8,'Dig2'8',Dig3'8',Dig4'8' D1,D4,D5,D6,D8	Green	2.1	2.5	V	IF=20mA
		D2,D3,D7,L					
IR	Reverse Current	Dig1'8,'Dig2'8',Dig3'8',Dig4'8' D1,D4,D5,D6,D8	Green		10	uA	VR = 5V
		D2,D3,D7,L			20		

Notes:

- Wavelength: +/-1nm.
- Forward Voltage: +/-0.1V.

Absolute Maximum Ratings at TA=25°C

Parameter		Green	Units
Power dissipation	Dig1'8,'Dig2'8',Dig3'8',Dig4'8' D1,D4,D5,D6,D8	75	mW
	D2,D3,D7,L	150	
DC Forward Current	Dig1'8,'Dig2'8',Dig3'8',Dig4'8' D1,D4,D5,D6,D8	30	mA
	D2,D3,D7,L	60	
Reverse Voltage	Dig1'8,'Dig2'8',Dig3'8',Dig4'8' D1,D4,D5,D6,D8	5	V
	D2,D3,D7,L		
Peak Forward Current [1]	Dig1'8,'Dig2'8',Dig3'8',Dig4'8' D1,D4,D5,D6,D8	150	mA
	D2,D3,D7,L	300	
Operating/Storage Temperature		-40°C To +85°C	
Lead Solder Temperature [2]		260°C For 3~5 Seconds	

Notes:

- 1/10 Duty Cycle, 0.1ms Pulse Width.
- 2mm below package base.



Green

CC25-11CGKWA

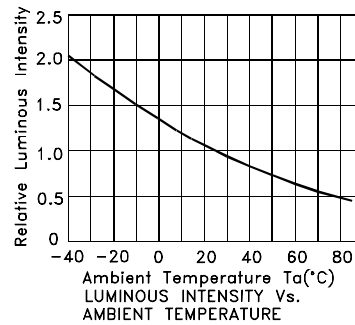
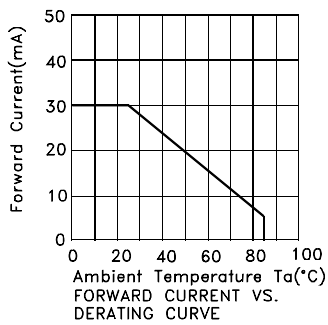
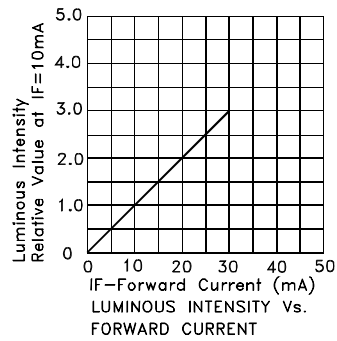
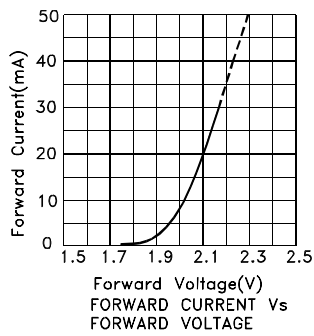

Green

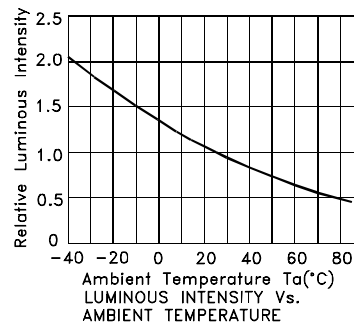
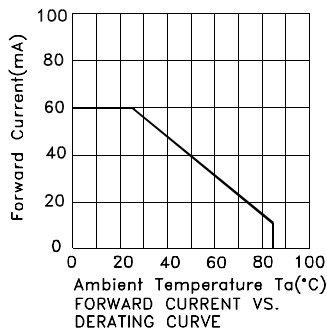
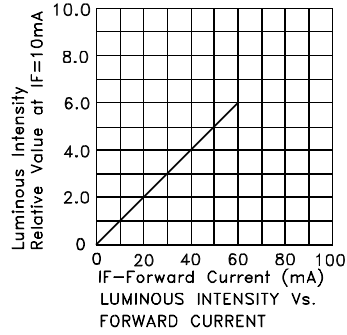
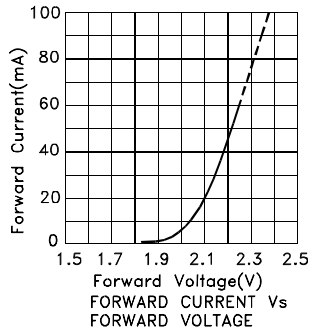

PACKING & LABEL SPECIFICATIONS

CC25-11CGKWA

