

Part Number: SC43-13SYKWA

Super Bright Yellow

Features

- 0.43 inch digit height.
- Low current operation.
- Excellent character appearance.
- Easy mounting on P.C. boards or sockets.
- Mechanically rugged.
- Standard : gray face, white segment.
- RoHS compliant.

Description

The Super Bright Yellow device is made with AlGaInP (on GaAs substrate) light emitting diode chip.

Package Dimensions & Internal Circuit Diagram

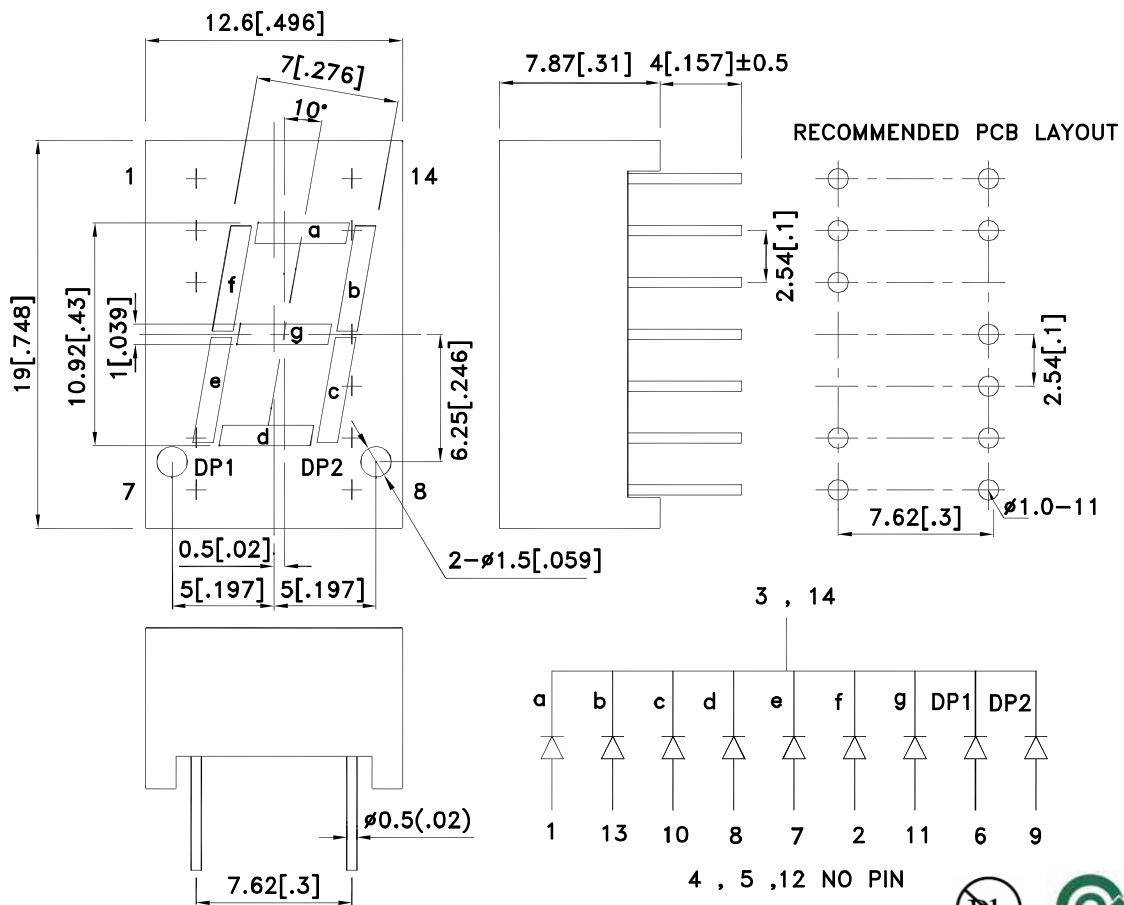

Notes:

1. All dimensions are in millimeters (inches), Tolerance is $\pm 0.25(0.01)$ unless otherwise noted.
2. The specifications, characteristics and technical data described in the datasheet are subject to change without prior notice.



Selection Guide

Part No.	Dice	Lens Type	Iv (ucd) [1] @ 10mA		Description
			Min.	Typ.	
SC43-13SYKWA	Super Bright Yellow (AlGaInP)	White Diffused	52000	95000	Common Cathode, Rt. &Lt. Hand Decimal.

Note:

1. Luminous intensity/ luminous Flux: +/-15%.

Electrical / Optical Characteristics at TA=25°C

Symbol	Parameter	Device	Typ.	Max.	Units	Test Conditions
λ_{peak}	Peak Wavelength	Super Bright Yellow	590		nm	I _F =20mA
λ_D [1]	Dominant Wavelength	Super Bright Yellow	590		nm	I _F =20mA
$\Delta\lambda_{1/2}$	Spectral Line Half-width	Super Bright Yellow	20		nm	I _F =20mA
C	Capacitance	Super Bright Yellow	20		pF	V _F =0V;f=1MHz
V _F [2]	Forward Voltage	Super Bright Yellow	2.0	2.5	V	I _F =20mA
I _R	Reverse Current	Super Bright Yellow		10	uA	V _R =5V

Notes:

1. Wavelength: +/-1nm.

2. Forward Voltage: +/-0.1V.

Absolute Maximum Ratings at TA=25°C

Parameter	Super Bright Yellow	Units
Power dissipation	75	mW
DC Forward Current	30	mA
Peak Forward Current [1]	175	mA
Reverse Voltage	5	V
Operating / Storage Temperature	-40°C To +85°C	
Lead Solder Temperature[2]	260°C For 3-5 Seconds	

Notes:

1. 1/10 Duty Cycle, 0.1ms Pulse Width.

2. 2mm below package base.

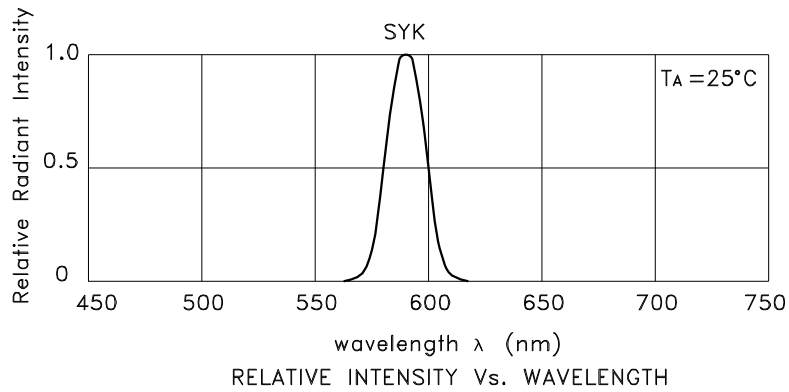

Super Bright Yellow SC43-13SYKWA

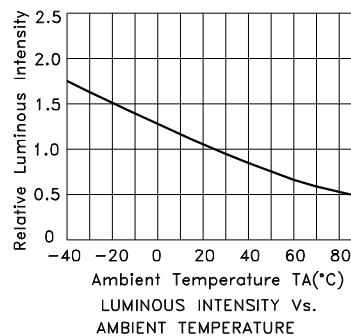
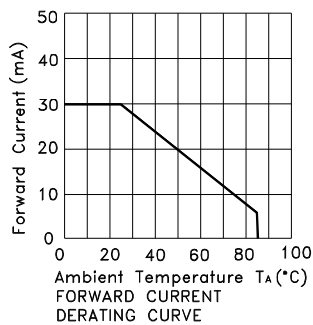
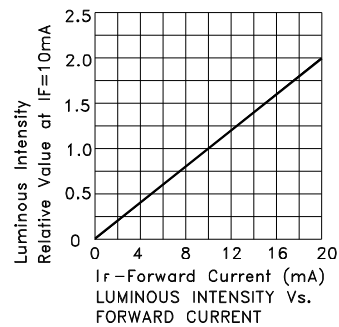
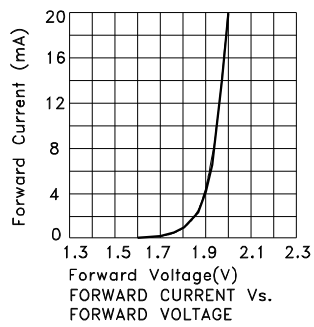

PACKING & LABEL SPECIFICATIONS

SC43-13SYKWA

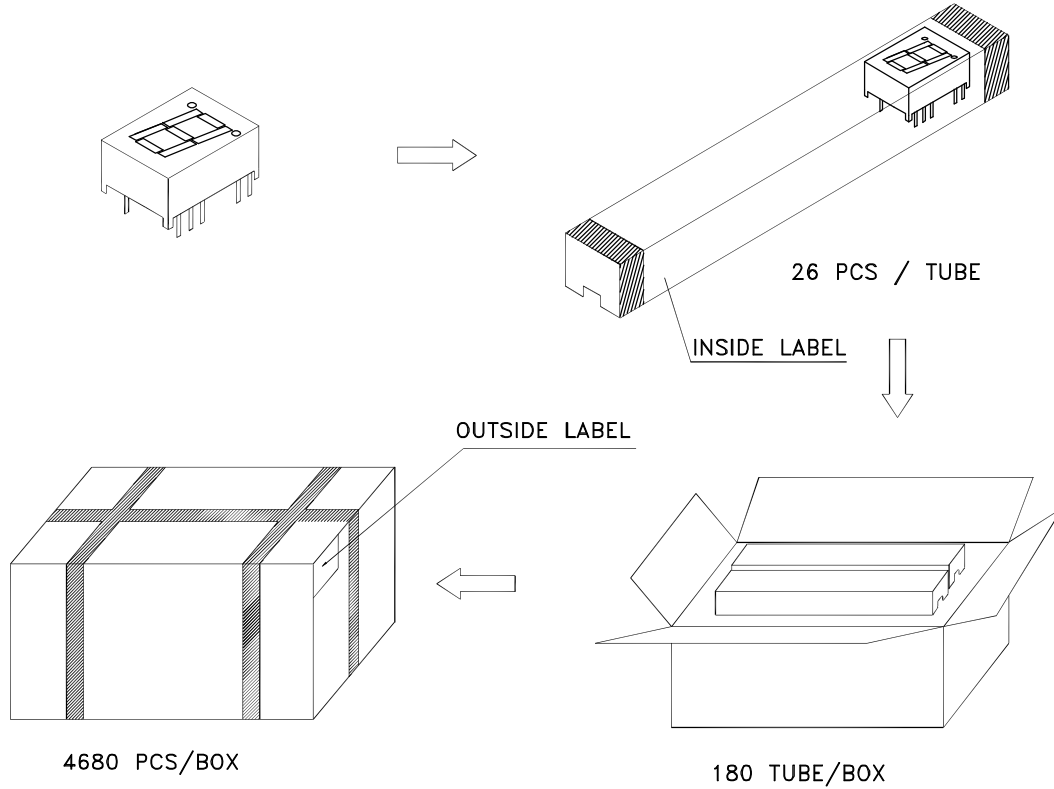

Inside Label On IC-tube

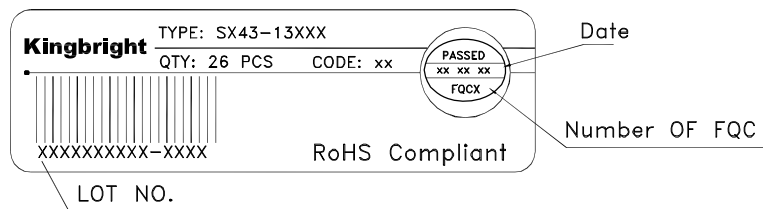

Outside Label On Box

