

Storage Choke, high design



Description

- Storage choke
- THT-terminals
- Inductor vertically positioned in housing
- Constant inductance at high alternating field modulation and large DC magnetization
- Reduced magnetic reversal

Standards

- EN 60938

Applications

- Storage of energy in switched power supplies
- Switch-mode
- Chopper amplifiers
- DC drives and stepper motor controls

Weblinks

[pdf-datasheet](#), [html-datasheet](#), [General Product Information](#), [Approvals](#), [RoHS](#), [CHINA-RoHS](#), [e-Shop](#), [SCHURTER-Stock-Check](#), [Distributor-Stock-Check](#), [Detailed request for product](#)

Technical Data

Rated voltage	up to 600 VDC
Rated Current	0.45 - 4.5 A @ Ta 70 °C
Rated inductance	0.01 - 2 mH, Tol. ±15%
Power Operating Frequency	up to 1 MHz
Terminal technic	THT
Weight	4 - 30 g
Material: Housing	UL 94V-0
Sealing Compound	UL 94V-0

Isolation Voltage	2 kV eff., winding to ambient
Climatic Category	40/125/21 acc. to IEC 60068-1
Allowable Operation Temp.	-40 °C to 125 °C

Dimensions

Case 01-1

Case 09-1

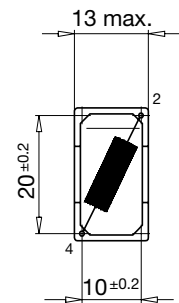
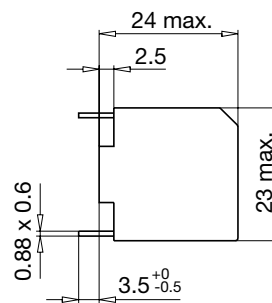
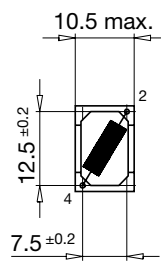
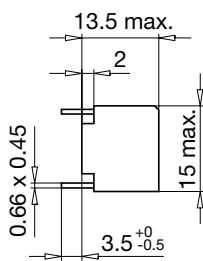

Case 19-1

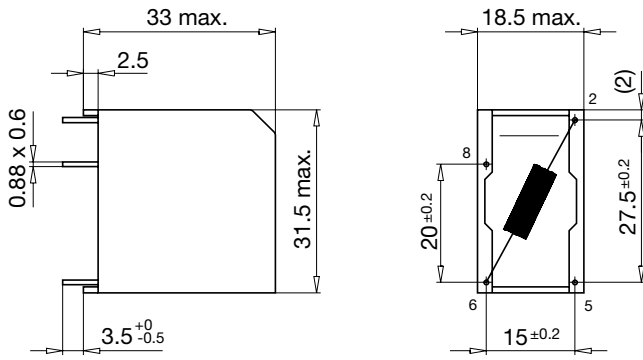

Diagrams

Application in DC-DC Converter

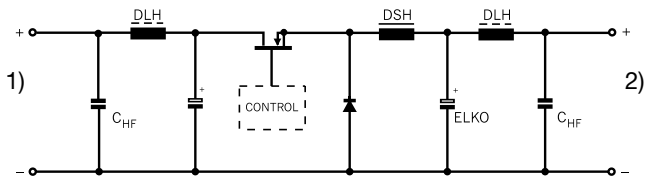

- 1) DC-Input unregulated
- 2) DC-Output regulated

Derating Curves

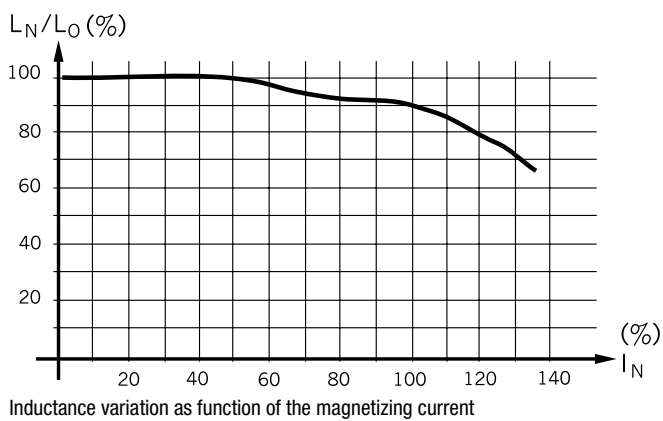

Variants

I_n [A]	L_n [mH]	R_{cu} [mΩ]	f_{RES} [MHz]	Weight [g]	Housing	Packing unit [pcs.]	Order Number
0.6	0.14	280	8	4	01-1	100	DSH-14-0001
1	0.05	100	12	4	01-1	100	DSH-14-0002
2	0.012	25	35	4	01-1	100	DSH-14-0003
0.45	2	1250	0.4	14	09-1	50	DSH-22-0001
0.63	1	750	1.8	14	09-1	50	DSH-22-0002
1	0.4	300	3	14	09-1	50	DSH-22-0003
1.4	0.2	160	4.8	14	09-1	50	DSH-22-0004
1.8	0.12	90	6.5	14	09-1	50	DSH-22-0005
3.15	0.04	33	14	14	09-1	50	DSH-22-0006
4.5	0.01	8	35	14	09-1	50	DSH-22-0008
4.5	0.02	20	-	14	09-1	50	DSH-22-0007
1.6	0.5	240	2.5	29	19-1	70	DSH-31-0001
2	0.3	140	3.5	29	19-1	70	DSH-31-0002
3.15	0.15	40	-	30	19-1	70	DSH-31-0003
4	0.1	40	6.5	30	19-1	70	DSH-31-0004
4.5	0.035	15	13	30	19-1	70	DSH-31-0005