

IEC Appliance Inlet C14 with Filter, Fuseholder 2-pole, Line Switch 2-pole

Standard- or Medical-Filter



Aluminum



Nickel plated steel



70° C



### Description

- Panel Mount:  
Screw-on mounting from front side
- 4 Functions:  
Appliance Inlet Protection class I, Line Switch 2-pole, Fuseholder for fuse-links 5 x 20 mm 2-pole, Line filter in standard and medical version
- Quick connect terminals 6.3 x 0.8 mm

### Approvals

- VDE Certificate Number: 40004665
- UL File Number: E72928

### Characteristics

- Compact design with optimal shielding
- All single elements are already wired
- Plug removal necessary for fuse-link replacement  
If the power entry module is installed as normal, it is not possible to touch any live parts with the test-finger according to IEC60529
- Fuse drawer meets requirements of medical standard IEC/EN 60601-1  
The fuseholder is accessible from the equipment front
- With EMC-shield
- Qualified for use in equipment according IEC/EN 60950

### Other versions on request

- Medical version M80

### References

Alternative: Standard version [FKH](#)

### Weblinks

[pdf-datasheet](#), [html-datasheet](#), [General Product Information](#), [Approvals](#), [RoHS](#), [CHINA-RoHS](#), [Mating Connectors](#), [e-Shop](#), [SCHURTER-Stock-Check](#), [Distributor-Stock-Check](#), [CAD-Drawings](#), [Accessories](#), [Detailed request for product](#)

### Technical Data

Ratings IEC	1 - 10A @ Ta 40 °C / 250VAC; 50Hz	Appliance-Inlet/-Outlet	C14 acc. to IEC/EN 60320-2-2 UL 498, CSA C22.2 no. 42 (for cold conditions) pin-temperature 70 °C, 10A, Protection Class I
Ratings UL/CSA	1 - 10A @ Ta 40 °C / 125VAC; 60Hz	Fuseholder	2-pole, Shocksafe category PC2 acc. to IEC 60127-6, for fuse-links 5 x 20mm
Leakage Current	standard < 0.25 mA (250V / 60Hz) medical < 5 µA (250 V / 60 Hz)	Rated Power Acceptance @ Ta 23 °C	5 x 20: 1.6W (2-pole)
Dielectric Strength	> 1.7 kVDC between L-N > 2.7 kVDC between L/N-PE Test voltage (2 sec)	Power Acceptance @ Ta > 23°C	Admissible power acceptance at higher ambient temperature see derating curves
Allowable Operation Temp.	-25 °C to 85 °C	Line Switch	2-pole, non-illuminated, acc. to IEC 61058-1 <a href="#">Technical Details</a>
Climatic Category	25/085/21 acc. to IEC 60068-1	Line Filter	Standard and Medical Version, IEC 60939, IEC 60601-1, UL 1283, UL 544, EN 133 200, CSA C22.2 no. 8 <a href="#">Technical Details</a>
Degree of Protection	from front side IP 40 acc. to IEC 60529	MTBF	> 1'700'000h acc. to MIL-HB-217 F
Protection Class	Suitable for appliances with protection class I acc. to IEC 61140		
Terminal	Quick connect terminals 6.3 x 0.8 mm		
Panel Thickness s	Screw: max 8 mm Mounting screw torque max 0.5 Nm		
Material: Housing	Thermoplastic, black, UL 94V-0		

Dimensions

Case 45

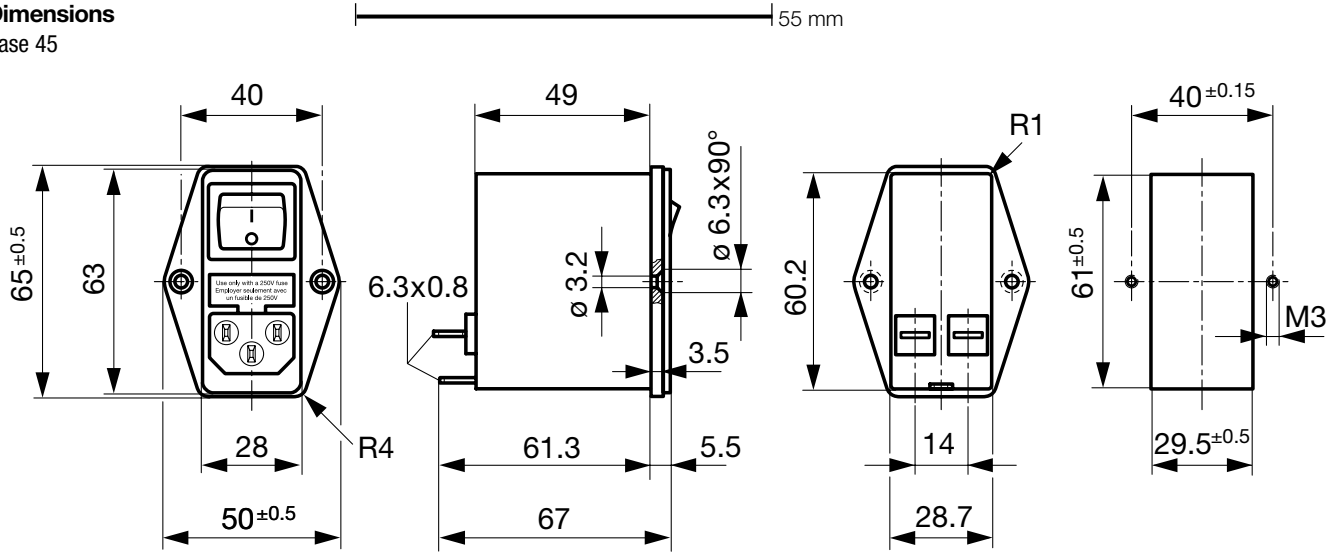

Case 50

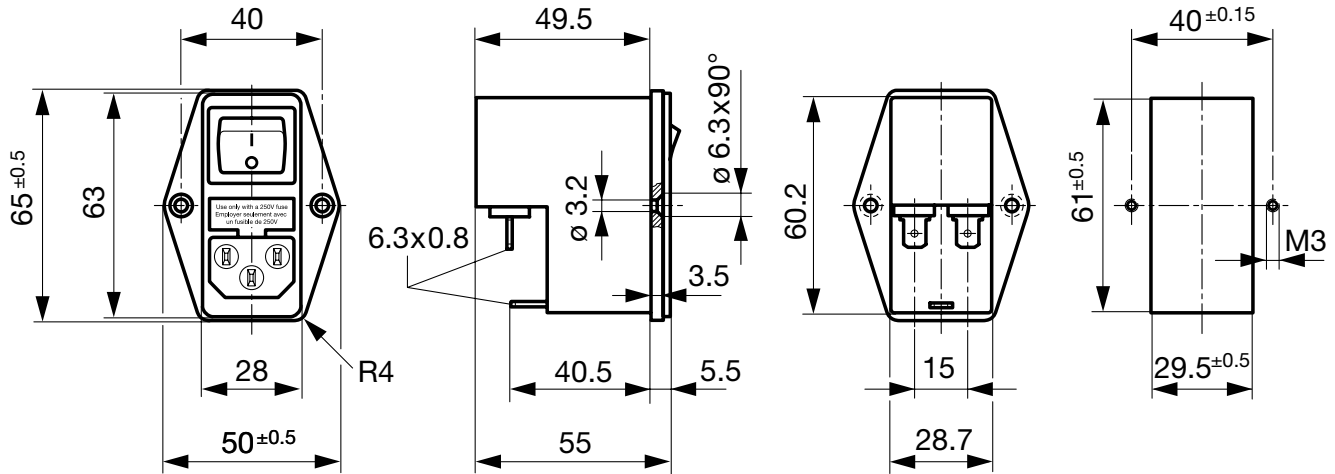

Technical Data of Filter-Components

Rated Current [A]	Filter-Type	Inductances L [mH]	Capacitance CX [nF]	Capacitance CY [nF]	R [MΩ]
1	Standard Version	2 x 10	68	2.2	1
2	Standard Version	2 x 4	68	2.2	1
4	Standard Version	2 x 1.5	68	2.2	1
6	Standard Version	2 x 0.8	68	2.2	1
10	Standard Version	2 x 0.3	68	2.2	1
1	Medical Version (M5)	2 x 10	68	-	1
2	Medical Version (M5)	2 x 4	68	-	1
4	Medical Version (M5)	2 x 1.5	68	-	1
6	Medical Version (M5)	2 x 0.8	68	-	1
10	Medical Version (M5)	2 x 0.3	68	-	1

**Diagrams**

Standard version

Medical version

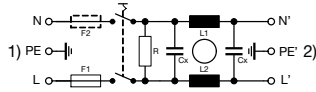
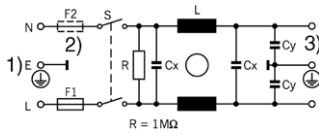

- 1) Line
- 2) only FKI
- 3) Load

- 1) Line
- 2) Load

**Derating Curves**

2-pole

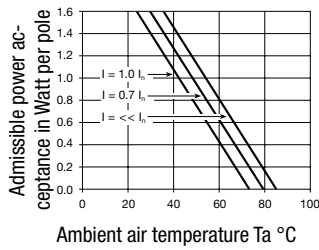

**Attenuation Loss**

- - - differential mode    \_\_\_\_\_ common mode

Standard version

1 A

2 A

4 A

6 A

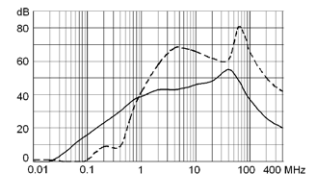
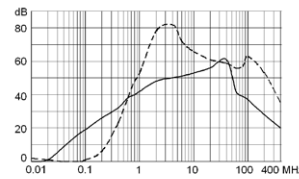
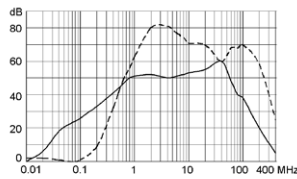
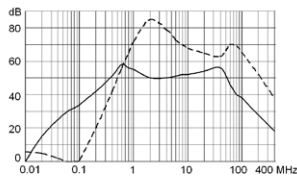

10 A

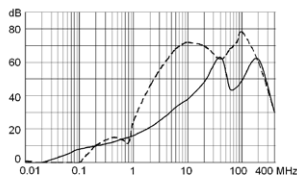

Medical version (M5)

1 A

2 A

4 A

6 A

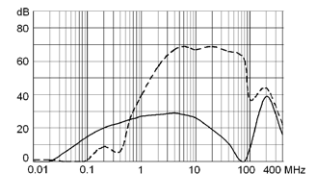
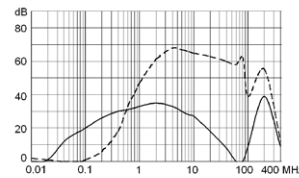
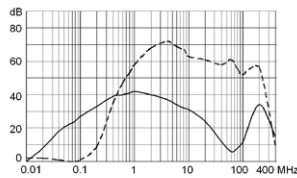
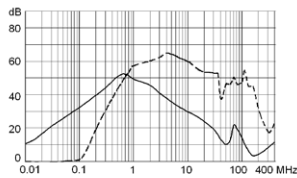

10 A

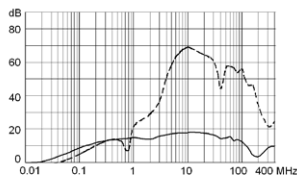

**Variants**

Socket and fuse drawer included

Type	Rated Current [A]	Filter-Type	Fuseholder	Line Switch	Housing	Material: Housing	Comment	Order Number
FKI	1	Standard Version	2-pole	2-pole	45	Aluminum	-	4304.4061
FKI	2	Standard Version	2-pole	2-pole	45	Aluminum	-	4304.4062
FKI	4	Standard Version	2-pole	2-pole	45	Aluminum	-	4304.4063
FKI	6	Standard Version	2-pole	2-pole	45	Aluminum	-	4304.4064
FKI	10	Standard Version	2-pole	2-pole	45	Aluminum	-	4304.4065
FKI	1	Medical Version (M5)	2-pole	2-pole	45	Aluminum	-	4304.4091
FKI	2	Medical Version (M5)	2-pole	2-pole	45	Aluminum	-	4304.4092
FKI	4	Medical Version (M5)	2-pole	2-pole	45	Aluminum	-	4304.4093
FKI	6	Medical Version (M5)	2-pole	2-pole	45	Aluminum	-	4304.4094
FKI	10	Medical Version (M5)	2-pole	2-pole	45	Aluminum	-	4304.4095
FKI	1	Standard Version	2-pole	2-pole	50	Nickel plated steel	-	4304.4021
FKI	2	Standard Version	2-pole	2-pole	50	Nickel plated steel	-	4304.4022
FKI	4	Standard Version	2-pole	2-pole	50	Nickel plated steel	-	4304.4023
FKI	6	Standard Version	2-pole	2-pole	50	Nickel plated steel	-	4304.4024
FKI	10	Standard Version	2-pole	2-pole	50	Nickel plated steel	-	4304.4025
FKI	1	Medical Version (M5)	2-pole	2-pole	50	Nickel plated steel	-	4304.4066
FKI	2	Medical Version (M5)	2-pole	2-pole	50	Nickel plated steel	-	4304.4067
FKI	4	Medical Version (M5)	2-pole	2-pole	50	Nickel plated steel	-	4304.4068
FKI	6	Medical Version (M5)	2-pole	2-pole	50	Nickel plated steel	-	4304.4069
FKI	10	Medical Version (M5)	2-pole	2-pole	50	Nickel plated steel	-	4304.4070

**Packaging unit** 10 Pcs

**Accessories**

**Description**



Assorted Covers  
Rear Cover

**Mating Outlets/Connectors**

**Category / Description**

[Appliance Outlet Overview complete](#)



IEC Appliance Outlet F, Screw-on Mounting, Front Side, Solder Terminal	4787
IEC Appliance Outlet F, Snap-in Mounting, Front Side, Solder or Quick-connect Terminal	4788
IEC Appliance Outlet F or H, Screw-on Mounting, Front Side, Solder, PCB or Quick-connect Terminal	5091
IEC Appliance Outlet F or H, Screw-on Mounting, Front Side, Solder or Quick-connect Terminal	5092

[Appliance Outlet further types to FKI](#)

[Connector Overview complete](#)



IEC Connector C15, Rewireable, Straight	0101
IEC Connector C15A, Rewireable, Straight	0102
IEC Connector C15A, Rewireable, Straight	0102-G
IEC Connector C15A, Rewireable, Angled	0112
IEC Connector C13, Rewireable, Angled	4012

[Connector further types to FKI](#)

...

**Category / Description**

[Power Cord Overview complete](#)



Power Cord with IEC Connector C13, Angled	0311
Power Cord with IEC Connector C13, Angled	3011
Power Cord with IEC Connector C13, Angled	3012
Power Cord with IEC Connector C13, Angled	3013
Power Cord with IEC Connector C13	3020
<a href="#">Power Cord further types to FKI</a>	...