

Part Number	Description
DR24D25	25A 275 Vac Output
DR24A25	25A 275 Vac Output
DR24A25-22	25A 275 Vac Output
DR48D25-21	25A 480 Vac Output
DR48D25	25A 510 Vac Output
DR48R25	25A 510 Vac Output
DR48A25	25A 510 Vac Output
DR48A25-22	25A 510 Vac Output
DR48D30	30A 510 Vac Output

Part Number Explanation

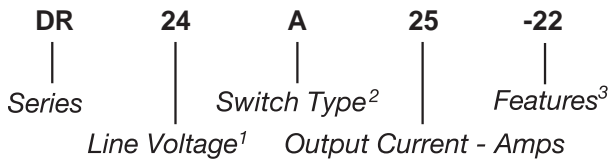

NOTES

- 1) Line Voltage (nominal): 24 = 240 Vac; 48 = 480Vac
- 2) Switch Type: D = Zero-cross turn-on; A = Zero-cross, AC control; R = Random turn-on
- 3) Features: 21 = self turn-on suppression; 22 = 24 Vac control

MECHANICAL SPECIFICATION

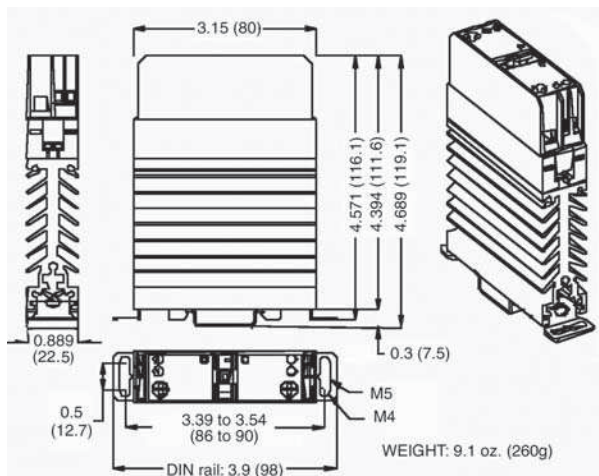

Figure 1 — DR relays; dimensions in inches (mm)



FEATURES/BENEFITS

- Mounting and dismounting on DIN rail without any tool or directly mountable on panel
- Zero-cross and random models; thyristors output
- Large control range
- Green control LED
- Very high immunity
- Low leakage current
- Internal transient suppression

DESCRIPTION

The Series DR single-phase DIN-rail relays are designed for all types of loads. The relays utilize optical isolation to protect the control from load transients. DR relays have an integral heat sink, and can be mounted and dismounted onto a DIN rail without any tools. The relays may also be panel mounted. All relays offer a green control LED and transient suppression.

APPLICATIONS

- Heating control
- Motor control
- Industrial and process control

APPROVALS

Series DR relays are pending UL recognition.

TYPICAL APPLICATION

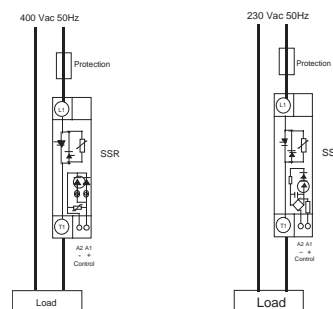

Figure 2 — DR relay DC control (left) and DR relay AC control (right)

CONTROL CHARACTERISTIC

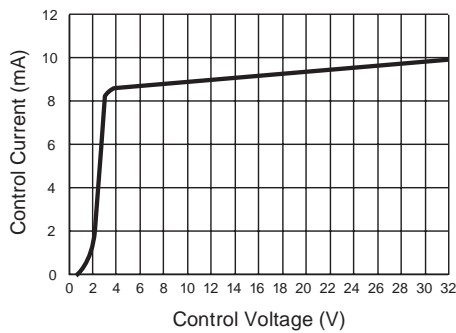

Figure 3a — DRXXD and DR48R relays

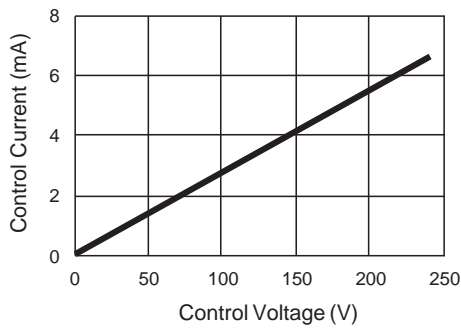

Figure 3b — DRXXA25 relays

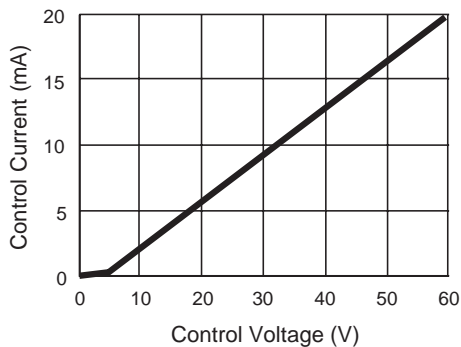

Figure 3c — DRXXA25-22 relays

INPUT (CONTROL) SPECIFICATION

	Min	Max	Units
Control Range			
DR24D25	3	32	Vdc
DR48R25	3.5	32	Vdc
DR48D25	3.5	32	Vdc
DR48D30	3.5	32	Vdc
DR48D25-21	3	32	Vdc
DRXXA25-22	17	60	Vac/dc
DRXXA25	150	240	Vac/dc

Control Current Range

DRXXDXX		10	mAdc
DR48R25		10	mAdc
DRXXA25	3	7	mA
DRXXA25-22	3	20	mA

Must Turn-Off Voltage

DR24D25	1	V
DR24A25	1	V
DR24A25-22	4	V
DR48D25-21	1	V
DR48R25	2	V
DR48D25	2	V
DR48A25	15	V
DR48A25-22	4	V
DR48D30	2	V

Reverse Voltage (DC Control)	32	V
Clamping Voltage (DC Control)	42	V
Input LED	Green	

THERMAL CHARACTERISTICS

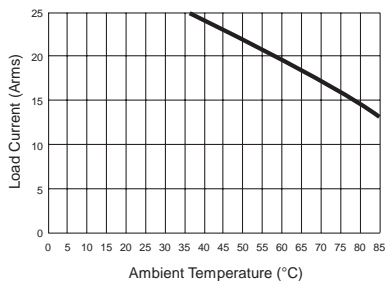

Figure 4a — DR24X25-XX relays

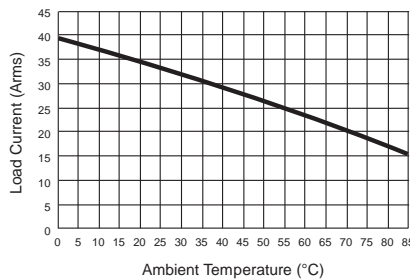

Figure 4b — DR48X25-XX relays

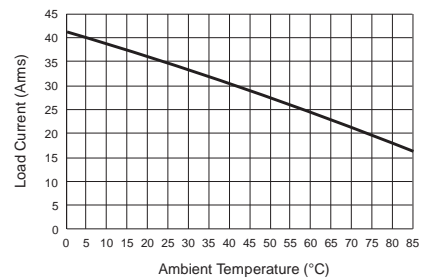

Figure 4c — DR48D30 relay

OUTPUT (LOAD) SPECIFICATION

	Min	Max	Unit
Operating Range			
DR24	12	275	Vrms
DR48D25-21	12	480	Vrms
DR48	24	510	Vrms
Peak Voltage			
DR24		600	Vpeak
DR48		1200	Vpeak
Clamping Voltage			
DR24 (@1mA)		430	V
DR48D25-21 (ON voltage, typical)		950	V
DR48 (@1mA)		820	V
Load Current Range (See Figure 4)			
DRXX25-XX	.005	25	Arms
DR48D30	.005	30	Arms
Zero-Cross Window (Typical)			
DR24		10	V
DR48D25-21		10	V
DR48R25		Random	
DR48D25		20	V
DR48A25		20	V
DR48A25-22		20	V
DR48D30		20	V
Non-Repetitive Overload Current (See Figure 5)			
DR24		250	A
DR48X25		550	A
DR48D30		1000	A
On-State Voltage Drop (Typical)			
DR24		0.85	V
DR48X25		0.9	V
DR48D30		0.75	V
Output Power Dissipation (Typical)			
DR24	$0.9xI+0.015xI^2$		W
DR48X25	$0.81xI+0.08xI^2$		W
DR48D30	$0.7xI+0.08xI^2$		W

OUTPUT (LOAD) SPECIFICATION (Continued)

	Min	Max	Unit
Thermal Resistance (Junction to Air)			
DR24		3.8	°C/W
DR48X25		3.3	°C/W
DR48D30		3.2	°C/W
Off-State Leakage Current (60Hz)			
		1	mA
Turn-On Time (60Hz)			
DRXXD		8.3	ms
DRXXA		24.9	ms
DR48R25		0.1	ms
Turn-Off Time (60Hz)			
DRXXD		8.3	ms
DRXXA		24.9	ms
DR48R25		8.3	ms
Operating Frequency Range			
	0.1	440	Hz
Off-State dv/dt			
		500	V/μs
I²t for match fusing (<8.3ms)			
DR24		312	A ² S
DR48X25		1500	A ² S
DR48D30		5000	A ² S

ENVIRONMENTAL SPECIFICATION

	Min	Max	Unit
Storage Temperature	-30	100	°C
Operating Temperature	-30	80	°C
Input-Output Isolation	4000		Vrms
Output-Case Isolation			
DR24	2500		Vrms
DR48	4000		Vrms
Insulation Resistance	100		MΩ
Rated Impulse Voltage	4000		V

SURGE CURRENTS

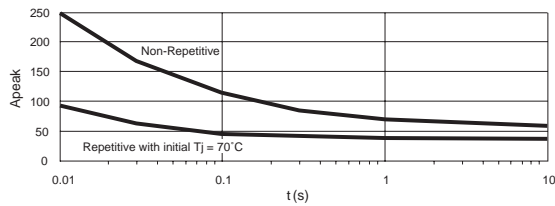

Figure 5a — DR24 relays

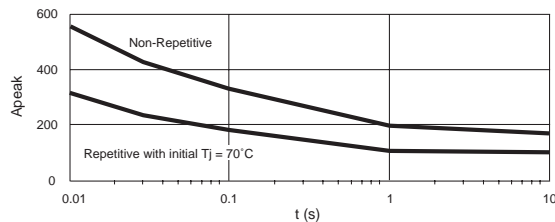

Figure 5b — DR48X25 relays

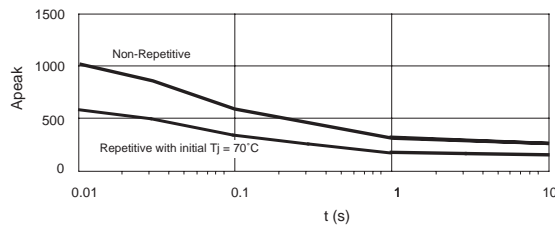

Figure 5c — DR48D30 relay

DIN-RAIL MOUNTING

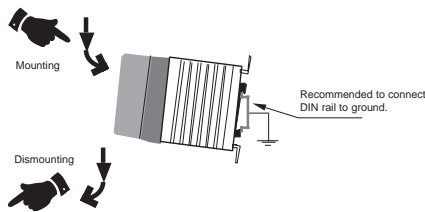

Figure 6 — DR relay

PANEL MOUNTING

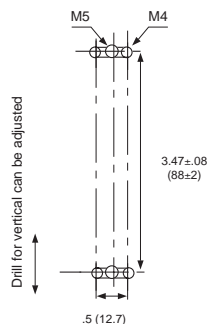
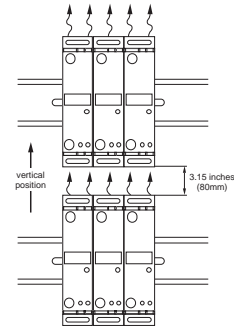

Figure 7 — DR relay

NOTES:

1. Connections: For output terminals, the wire cross sections must be adapted to the load current and to the overcurrent protection device characteristics. The relay rated voltage must be adapted to the mains rated voltage. These relays use screw clamp connections.

2. Mounting: Only in vertical position. Protect heat-sensitive materials as well as people from contact with the heat sink. For non vertical mounting, the load current must be derated by 50%. The SSR requires air convection. Lack of air convection produces an abnormal heating. Keep a distance between the upper SSR and the lower SSR (see figure on the right). In case of zero space between two SSRs, reduce the load current. It's suggested to maintain the heat sink temperature under 90°C. Forced cooling significantly improves the thermal performances.



3. Typical application loads: The DR relay may handle motor and resistive loads. For different loads, check the inrush current at turn-ON and possible overvoltages at turn-OFF or contact the factory.

- Incandescent lamps — Inrush current is generally 10 times the current nominal for 10ms.
- Electric discharge lamp — These loads often have overcurrent at turn-ON and overvoltage at turn-OFF. Use 480Vac SSR on 240Vac mains.
- Transformer loads — Very high inrush current, up to 100 times the nominal current.
- Capacitive loads — Very high current at turn-On and overvoltage at turn-Off. Use only zero-cross models.

4. Protection: To protect the SSR against a short-circuit of the load, use a fuse with a I^2t value = 1/2 I^2t value.

5. EMC:

- Immunity:** Immunity levels of the DR comply with EN61000-4-4 & 5.
- Emission:** The system integrator must ensure that systems containing SSRs comply with the requirements of any rules and regulations applicable at the system level. The very low zero-cross voltage (<20V) improves the conducted emission level in comparison with most SSRs with zero-cross voltage higher than 50V.

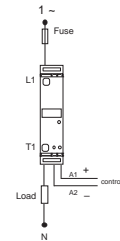

6. All electrical parameters specified at 25°C unless otherwise noted.

CONNECTIONS

wires (mm ²)	torques	screwdriver
control 1 x (0.75-->2.5) L = 6mm	0.4N.m (0.6N.m max)	3.5 x 0.5mm
Power 1 x (1.5-->16) 1 x (1.5-->10) L = 10mm	1.2N.m (1.8N.m max)	Pozidriv2/ 0.8 x 5.5 (1 x 6)

Figure 8 — DR relay