

Part Number	Description
PS24D4G	4A, 275 Vac
PS3R5G	5A, 30 Vdc

Part Number Explanation

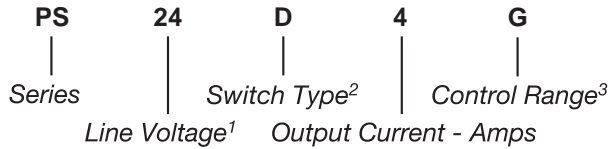

NOTES
1) Line Voltage (nominal): 24 = 240 Vac; 3 = 30 Vdc
2) Switch Type: D = Zero-cross turn-on; R = Random turn-on
3) Control Range: G = 12–30 Vdc/Vac (PS24D4G)
G = 12–30 Vdc (PS3R5G)

MECHANICAL SPECIFICATION

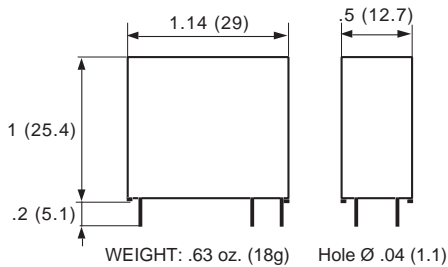

Figure 1 — PS relays; dimensions in inches (mm)

BLOCK DIAGRAM

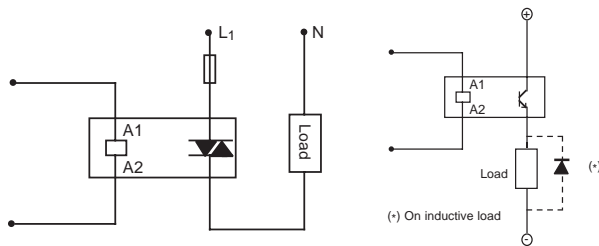

Figure 2a — PS24D4G

Figure 2b — PS3R5G

GRID DIAGRAM

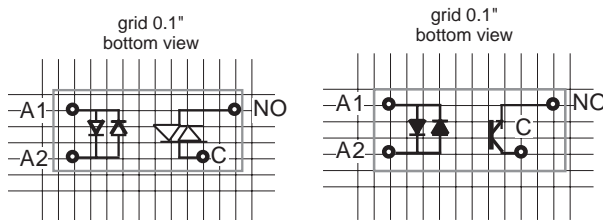

Figure 3a — PS24D4G

Figure 3b — PS3R5G



FEATURES/BENEFITS

- Pin-to-pin compatible with electromechanical relays
- AC/DC control (PS24)
- Tight zero-cross window for low EMI (AC)
- Compact size
- AC and DC models available
- High immunity to surges

DESCRIPTION

The Series PS relays provide medium-power switching in a compact size. The PS24 relays are designed to operate with an AC or DC control. These relays are capable of withstanding high surge currents. The PS relays are pin-to-pin compatible with electromechanical relays.

APPLICATIONS

- Interface applications
- Vending machines
- Light/lamp control
- Contactor driver
- Fan speed control

APPROVALS

All models are UL recognized.
UL File Number: E128555.

INPUT (CONTROL) SPECIFICATION

	Min	Max	Units
Control Range			
PS24D4G	12	30	Vac/dc
PS3R5G	12	30	Vdc
Input Current Range	4.1	13	mA
(See Figure 4)			
Must Turn-Off Voltage		2.5	V
Input Resistance (Typical)		2100	Ohms

OUTPUT (LOAD) SPECIFICATION

	Min	Max	Unit
Operating Range			
PS24D4G	12	275	Vrms
PS3R5G	0	30	V
Peak Voltage			
PS24D4G		600	V
PS3R5G		60	V
Load Current Range			
PS24D4G	.05	4	Arms
PS3R5G	.001	5	Arms
Maximum Surge Current Rating (Non-Repetitive) (See Figure 6)			
PS24D4G		100	A
PS3R5G		25	A
On-State Voltage Drop			
PS24D4G		1.1	V
PS3R5G		0.3	V
Zero-Cross Window (Typical)			
PS24D4G		±10	V
PS3R5G		NA	
Off-State Leakage Current (60Hz)			
All relays		1	mA

OUTPUT (LOAD) SPECIFICATION (Continued)

	Min	Max	Unit
Turn-On Time (60Hz)			
PS24D4G		10	ms
PS3R5G		50	µs
Turn-Off Time (60Hz)			
PS24D4G		17	ms
PS3R5G		600	µs
Off-State dv/dt			
PS24D4G		500	V/µs
Switching Frequency			
PS3R5G		100	Hz
Operating Frequency			
PS24D4G	1	440	Hz
I²t for match fusing (<8.3ms)			
PS24D4G		50	A ² S

CONTROL CHARACTERISTIC

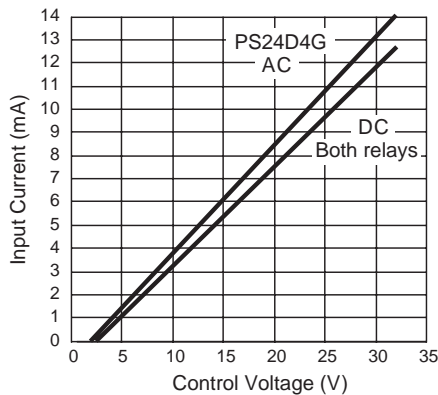

Figure 4 — PS relays

ENVIRONMENTAL SPECIFICATION

	Min	Max	Unit
Maximum Junction Temperature		125	°C
Operating Temperature			
PS24D4G	-40	100	°C
PS3R5G	-40	100	°C
Input-Output Isolation			
PS24D4G	4000		V
PS3R5G	2500		V
Junction-Case Thermal Resistance			
PS24D4G		7.4	°C/W
PS3R5G		12	°C/W
Junction-Ambient Thermal Resistance			
PS24D4G		30	°C/W
PS3R5G		41	°C/W
Case Thermal Delay Time			
PS24D4G		6	minute
PS3R5G		8	minute
Maximum Soldering Heat (1mm case)	260		°C

NOTES:

1. Electrical specifications at 25°C unless otherwise specified.
2. On inductive loads, a free-wheeling diode (or clamp) is recommended.
3. PS3R5G no polarity on the control pins.
4. For additional/custom options, contact factory.

THERMAL CURVE

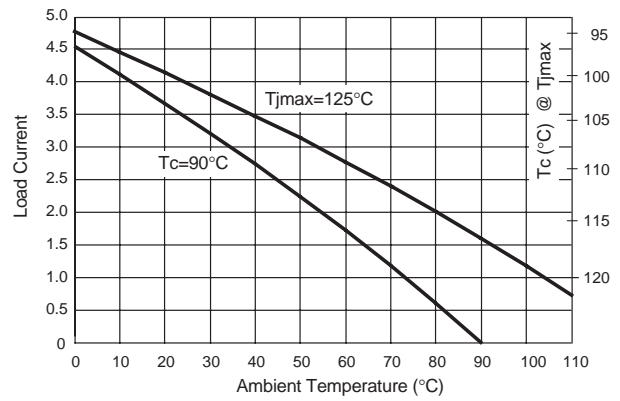

Figure 5a — PS24D4G

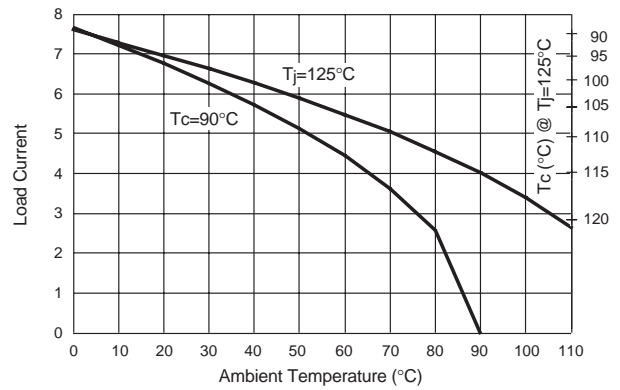

Figure 5b — PS3R5G

NON-REPETITIVE SURGE CURRENT

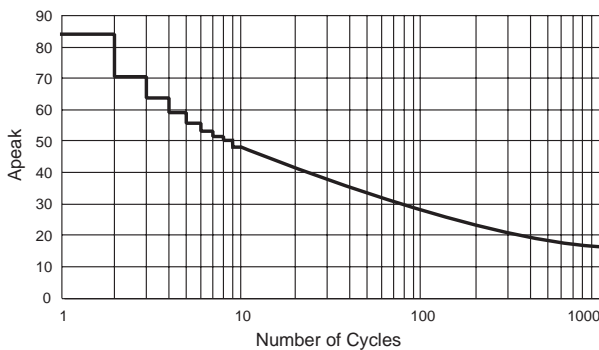

Figure 6a — PS24D4G

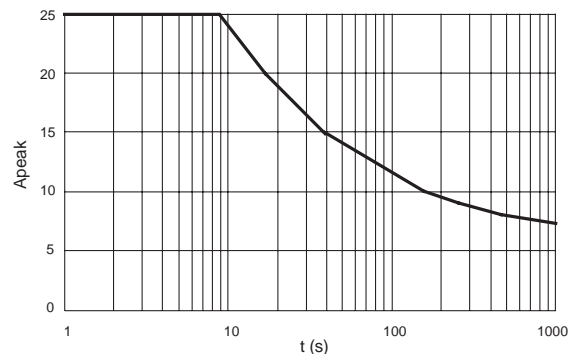

Figure 6b — PS3R5G