

Part Number	Description
X24D12	12A, 280 Vac
X24D16	16A, 280 Vac

Part Number Explanation

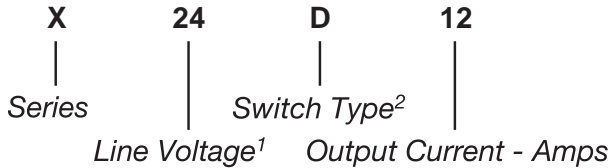

NOTES

- 1) Line Voltage (nominal): 24 = 240 Vac
- 2) Switch Type: D = Zero-cross turn-on

MECHANICAL SPECIFICATION

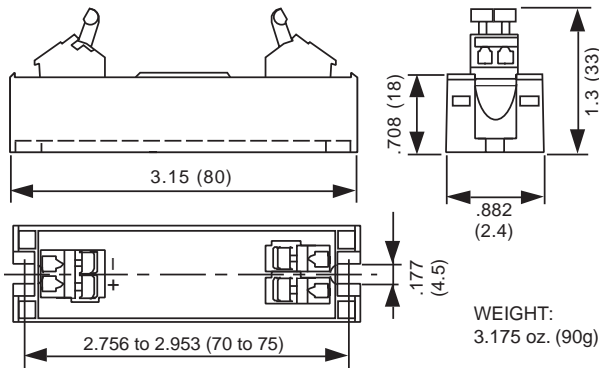

Figure 1 — X relays; dimensions in inches (mm)

CONNECTIONS

Wires	Tool
<ul style="list-style-type: none"> 1 x (0.14-->2.5mm²) 1 x (22-->12AWG) L = 0.2362 (6mm) 	Screwdriver or fingers



Figure 2 — X relays



FEATURES/BENEFITS

- Compact size
- Spring terminals
- Tight zero-cross window for low EMI
- Touch-proof terminals
- Designed for medium-power applications

DESCRIPTION

The Series X relays are designed in a thin compact plastic package. The X relays offer touch-proof spring terminals for ease of use and user safety. With its medium-power handling capabilities and compact size, the Series X is an excellent choice for medium-power AC loads.

APPLICATIONS

- Heating control
- Motor control
- Uninterruptible power supplies
- Light dimmers
- Industrial and process control
- On/Off controls of medium-power AC equipment

APPROVALS

Series X relays are UL pending.

TYPICAL APPLICATION

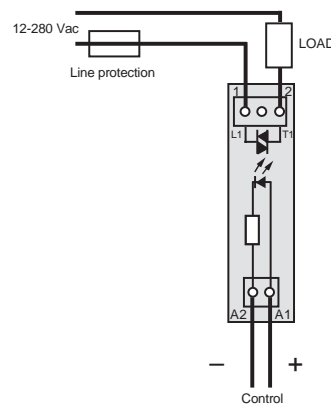

Figure 3 — X relays

INPUT (CONTROL) SPECIFICATION

	Min	Max	Units
Control Range	7	30	Vdc
Input Current Range	5	30	mAdc
Must Turn-Off Voltage		1	Vdc
Input Resistance (Typical)		1000	Ohms
Reverse Voltage Protection		30	V

OUTPUT (LOAD) SPECIFICATION

	Min	Max	Units
Operating Range	12	280	Vrms
Peak Voltage		600	Vpeak

Load Current Range (Resistive)

X24D12	.005	12	Arms
X24D16	.005	25*	Arms

*Terminals limited at 16A

Maximum Surge Current Rating (Non-Repetitive)

X24D12		120	A
X24D16		250	A

On-State Voltage Drop		1.3	V
Zero-Cross Window (Typical)		±12	Vac
Off-State Leakage Current (60Hz)		1	mA
Turn-On Time (60 Hz)		8.3	ms
Turn-Off Time (60 Hz)		8.3	ms
Off-State dv/dt		500	V/μs
Maximum di/dt (Non-Repetitive)		50	A²s
Operating Frequency Range	0.1	440	Hz

I²t for Match Fusing (<8.3ms)

X24D12	.005	72	A²S
X24D16	.005	310	A²S

ENVIRONMENTAL SPECIFICATION

	Min	Max	Units
Operating Temperature	-40	100	°C
Storage Temperature	-40	100	°C
Input-Output Isolation	4000		Vrms
Output-Case Isolation	2500		Vrms

CONTROL CHARACTERISTIC

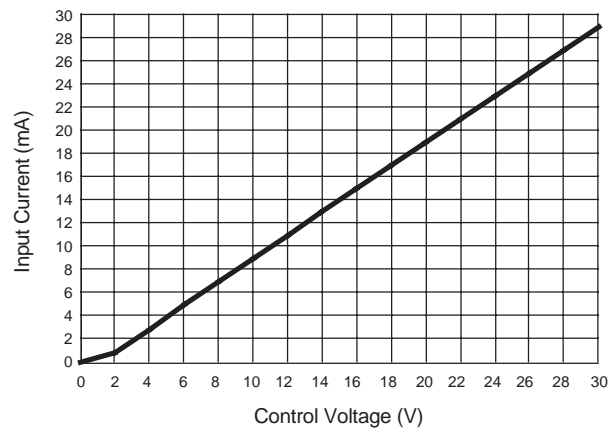

Figure 4 — X relays

SURGE CURRENT

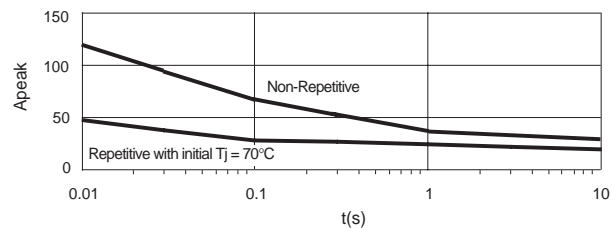

Figure 5a — X24D12 relay

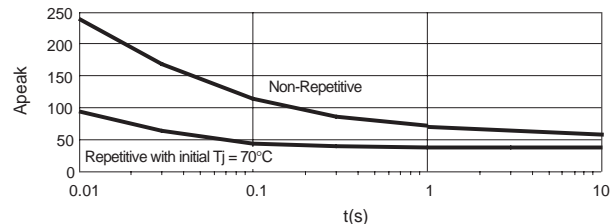

Figure 5b — X24D16 relay

THERMAL CHARACTERISTICS

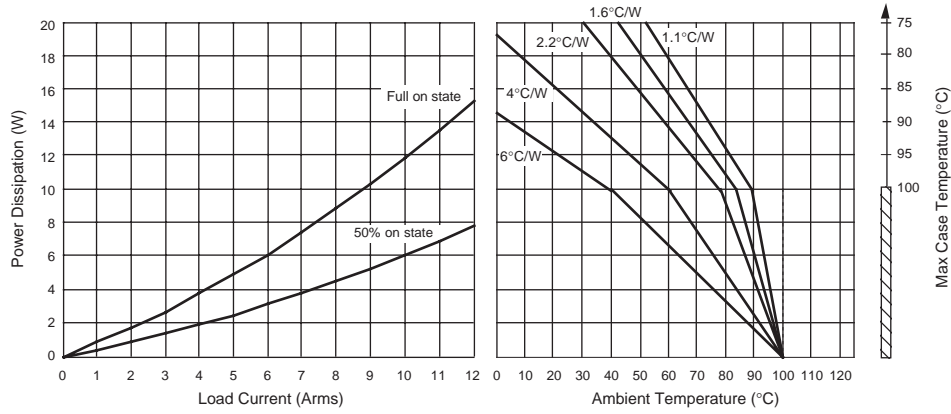

Figure 6a — X24D12 relay

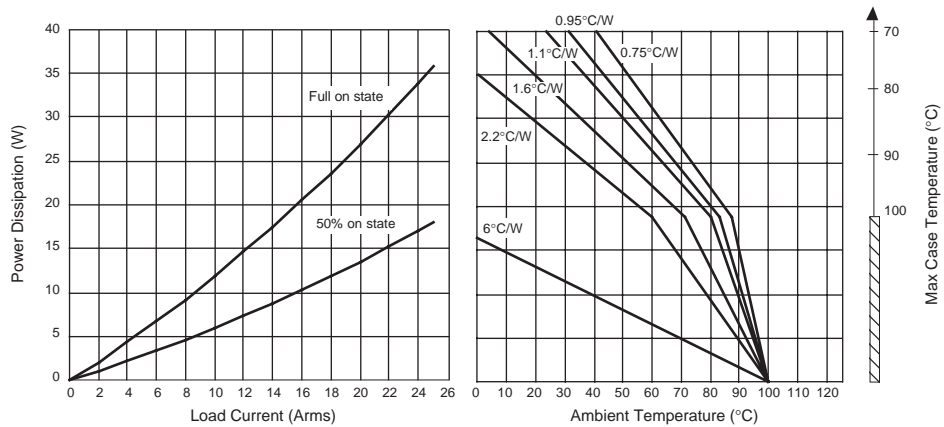

Figure 6b — X24D16 relay

NOTES:

1. External snubber is recommended when switching inductive loads.
2. Electrical specifications at 25°C unless otherwise specified.
3. For 800Hz applications, contact factory.
4. For additional/custom options, contact factory.