

**NPN Silicon Germanium RF Transistor\***

- High gain low noise RF transistor
- Provides outstanding performance for a wide range of wireless applications
- Ideal for CDMA and WLAN applications
- Outstanding noise figure  $F = 0.65$  dB at 1.8 GHz  
Outstanding noise figure  $F = 1.2$  dB at 6 GHz
- High maximum stable gain  
 $G_{ms} = 23$  dB at 1.8 GHz
- Gold metallization for extra high reliability
- 70 GHz  $f_T$ -Silicon Germanium technology
- Pb-free (RoHS compliant) package<sup>1)</sup>
- Qualified according AEC Q101

\* Short term description



**ESD (Electrostatic discharge) sensitive device, observe handling precaution!**

Type	Marking	Pin Configuration						Package
BFP640F	R4s	1=B	2=E	3=C	4=E	-	-	TSFP-4

<sup>1)</sup>Pb-containing package may be available upon special request

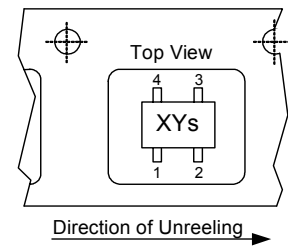
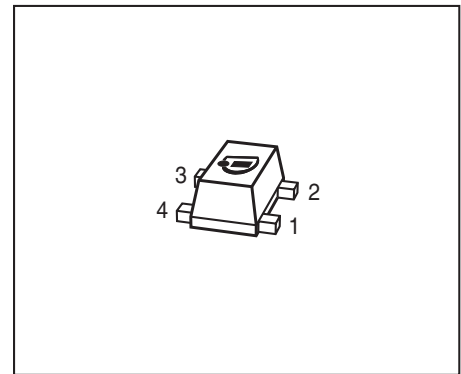

**Maximum Ratings**

Parameter	Symbol	Value	Unit
Collector-emitter voltage $T_A > 0^\circ\text{C}$ $T_A \leq 0^\circ\text{C}$	$V_{\text{CEO}}$	4 3.7	V
Collector-emitter voltage	$V_{\text{CES}}$	13	
Collector-base voltage	$V_{\text{CBO}}$	13	
Emitter-base voltage	$V_{\text{EBO}}$	1.2	
Collector current	$I_{\text{C}}$	50	mA
Base current	$I_{\text{B}}$	3	
Total power dissipation <sup>1)</sup> $T_S \leq 92^\circ\text{C}$	$P_{\text{tot}}$	200	mW
Junction temperature	$T_{\text{j}}$	150	$^\circ\text{C}$
Ambient temperature	$T_{\text{A}}$	-65 ... 150	
Storage temperature	$T_{\text{stg}}$	-65 ... 150	

**Thermal Resistance**

Parameter	Symbol	Value	Unit
Junction - soldering point <sup>2)</sup>	$R_{\text{thJS}}$	$\leq 290$	K/W

**Electrical Characteristics at  $T_A = 25^\circ\text{C}$ , unless otherwise specified**

Parameter	Symbol	Values			Unit
		min.	typ.	max.	
Collector-emitter breakdown voltage $I_{\text{C}} = 1 \text{ mA}, I_{\text{B}} = 0$	$V_{(\text{BR})\text{CEO}}$	4	4.5	-	V
Collector-emitter cutoff current $V_{\text{CE}} = 13 \text{ V}, V_{\text{BE}} = 0$	$I_{\text{CES}}$	-	-	30	$\mu\text{A}$
Collector-base cutoff current $V_{\text{CB}} = 5 \text{ V}, I_{\text{E}} = 0$	$I_{\text{CBO}}$	-	-	100	nA
Emitter-base cutoff current $V_{\text{EB}} = 0.5 \text{ V}, I_{\text{C}} = 0$	$I_{\text{EBO}}$	-	-	3	$\mu\text{A}$
DC current gain $I_{\text{C}} = 30 \text{ mA}, V_{\text{CE}} = 3 \text{ V}, \text{puls measured}$	$h_{\text{FE}}$	110	180	270	-

<sup>1)</sup>  $T_S$  is measured on the collector lead at the soldering point to the pcb

<sup>2)</sup> For calculation of  $R_{\text{thJA}}$  please refer to Application Note Thermal Resistance

**Electrical Characteristics at  $T_A = 25^\circ\text{C}$ , unless otherwise specified**

Parameter	Symbol	Values			Unit
		min.	typ.	max.	
<b>AC Characteristics (verified by random sampling)</b>					
Transition frequency $I_C = 30\text{ mA}$ , $V_{CE} = 3\text{ V}$ , $f = 1\text{ GHz}$	$f_T$	30	40	-	GHz
Collector-base capacitance $V_{CB} = 3\text{ V}$ , $f = 1\text{ MHz}$ , $V_{BE} = 0$ , emitter grounded	$C_{cb}$	-	0.09	0.2	pF
Collector emitter capacitance $V_{CE} = 3\text{ V}$ , $f = 1\text{ MHz}$ , $V_{BE} = 0$ , base grounded	$C_{ce}$	-	0.18	-	
Emitter-base capacitance $V_{EB} = 0.5\text{ V}$ , $f = 1\text{ MHz}$ , $V_{CB} = 0$ , collector grounded	$C_{eb}$	-	0.5	-	
Noise figure $I_C = 5\text{ mA}$ , $V_{CE} = 3\text{ V}$ , $f = 1.8\text{ GHz}$ , $Z_S = Z_{Sopt}$ $I_C = 5\text{ mA}$ , $V_{CE} = 3\text{ V}$ , $f = 6\text{ GHz}$ , $Z_S = Z_{Sopt}$	$F$	-	0.65 1.2	-	dB
Power gain, maximum stable <sup>1)</sup> $I_C = 30\text{ mA}$ , $V_{CE} = 3\text{ V}$ , $Z_S = Z_{Sopt}$ , $Z_L = Z_{Lopt}$ , $f = 1.8\text{ GHz}$	$G_{ms}$	-	23	-	dB
Power gain, maximum available <sup>1)</sup> $I_C = 30\text{ mA}$ , $V_{CE} = 3\text{ V}$ , $Z_S = Z_{Sopt}$ , $Z_L = Z_{Lopt}$ , $f = 6\text{ GHz}$	$G_{ma}$	-	12	-	dB
Transducer gain $I_C = 30\text{ mA}$ , $V_{CE} = 3\text{ V}$ , $Z_S = Z_L = 50\ \Omega$ , $f = 1.8\text{ GHz}$ $f = 6\text{ GHz}$	$ S_{21e} ^2$	-	20.5 10	-	dB
Third order intercept point at output <sup>2)</sup> $V_{CE} = 3\text{ V}$ , $I_C = 30\text{ mA}$ , $Z_S = Z_L = 50\ \Omega$ , $f = 1.8\text{ GHz}$	$IP_3$	-	27.5	-	dBm
1dB Compression point at output $I_C = 30\text{ mA}$ , $V_{CE} = 3\text{ V}$ , $Z_S = Z_L = 50\ \Omega$ , $f = 1.8\text{ GHz}$	$P_{-1dB}$	-	13.5	-	

$$^1G_{ma} = |S_{21e} / S_{12e}| (k - (k^2 - 1)^{1/2}), G_{ms} = |S_{21e} / S_{12e}|$$

<sup>2)</sup>IP3 value depends on termination of all intermodulation frequency components.  
Termination used for this measurement is  $50\ \Omega$  from 0.1 MHz to 6 GHz

**SPICE Parameter (Gummel-Poon Model, Berkley-SPICE 2G.6 Syntax):**
**Transistor Chip Data:**

IS =	0.22	fA	BF =	450	-	NF =	1.025	-
VAF =	1000	V	IKF =	0.15	A	ISE =	21	fA
NE =	2	-	BR =	55	-	NR =	1	-
VAR =	2	V	IKR =	3.8	mA	ISC =	400	fA
NC =	1.8	-	RB =	3.129	$\Omega$	IRB =	1.522	mA
RBM =	2.707	$\Omega$	RE =	0.6	-	RC =	3.061	$\Omega$
CJE =	227.6	fF	VJE =	0.8	V	MJE =	0.3	-
TF =	1.8	ps	XTF =	10	-	VTF =	1.5	V
ITF =	0.4	A	PTF =	0	deg	CJC =	67.43	fF
VJC =	0.6	V	MJC =	0.5	-	XCJC =	1	-
TR =	0.2	ns	CJS =	93.4	fF	VJS =	0.6	V
MJS =	0.27	-	XTB =	-1.42	-	EG =	1.078	eV
XTI =	3	-	FC =	0.8	-	TNOM	298	K
AF =	2	-	KF =	7.291E-11	-			
TITF1	-0.0065	-	TITF2	1.0E-5	-			

All parameters are ready to use, no scaling is necessary.

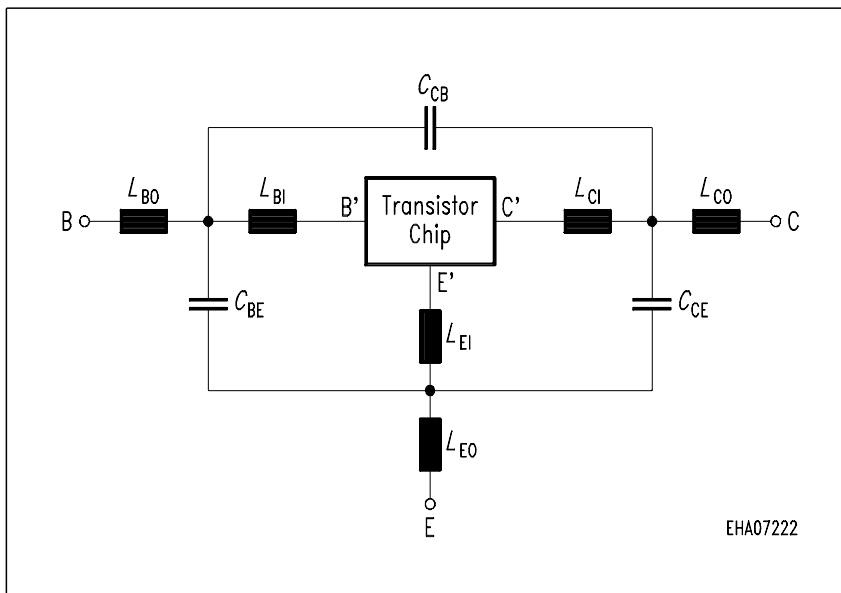
**Package Equivalent Circuit:**

For examples and ready to use parameters please contact your local Infineon Technologies distributor or sales office to obtain a Infineon Technologies CD-ROM or see Internet: <http://www.infineon.com>

LBO =	0.22	nH
LEO =	0.28	nH
LCO =	0.22	nH
LBI =	0.42	nH
LEI =	0.26	nH
LCI =	0.35	nH
CBE =	34	fF
CBC =	2	fF
CCE =	33	fF
KBO-EO =	0.1	-
KBO-CO =	0.01	-
KEO-CO =	0.11	-
KCI-EI =	0.2	-
KBI-CI =	-0.08	-
KBI-EI =	-0.05	-
RLBI =	0.15	$\Omega$
RLEI =	0.11	$\Omega$
RLCI =	0.13	$\Omega$

Valid up to 6GHz

**Total power dissipation  $P_{tot} = f(T_S)$**

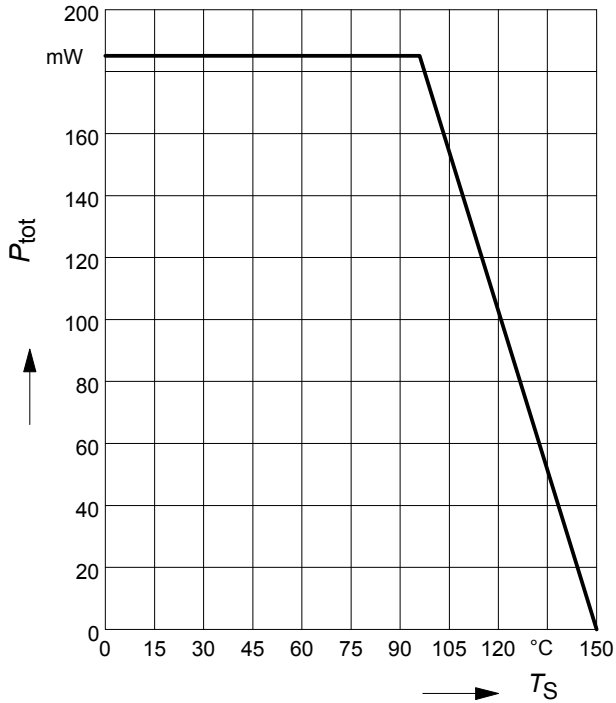

**Permissible Pulse Load  $R_{thJS} = f(t_p)$**

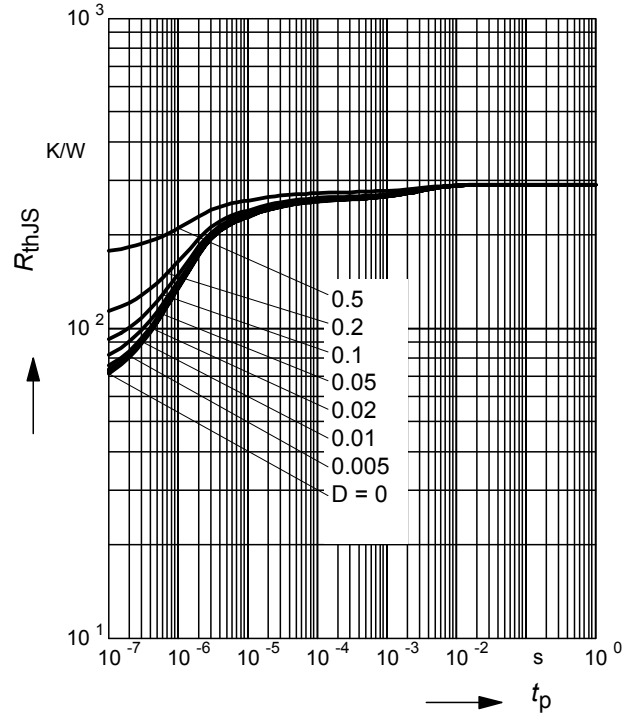

**Permissible Pulse Load**

$P_{totmax}/P_{totDC} = f(t_p)$

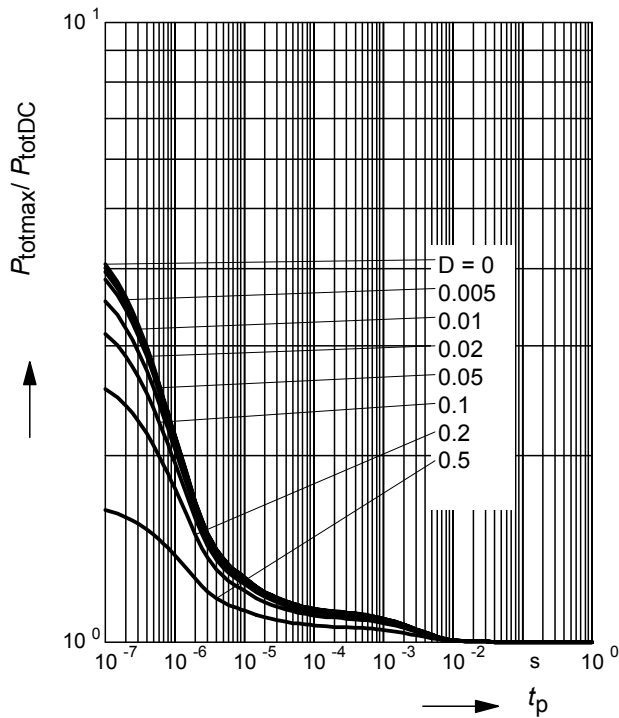

**Collector-base capacitance  $C_{cb} = f(V_{CB})$**

$f = 1\text{MHz}$

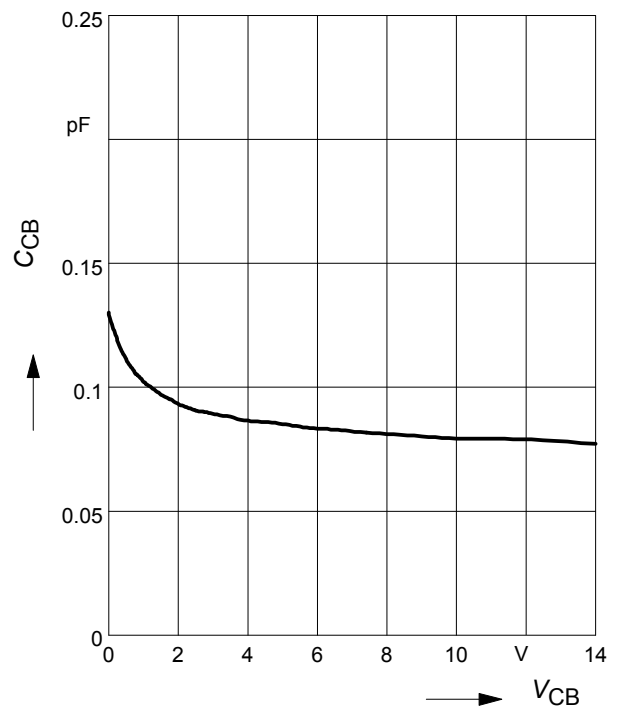

**Third order Intercept Point  $IP_3=f(I_C)$**

(Output,  $Z_S=Z_L=50\Omega$ )

$V_{CE}$  = parameter,  $f = 1.8$  GHz

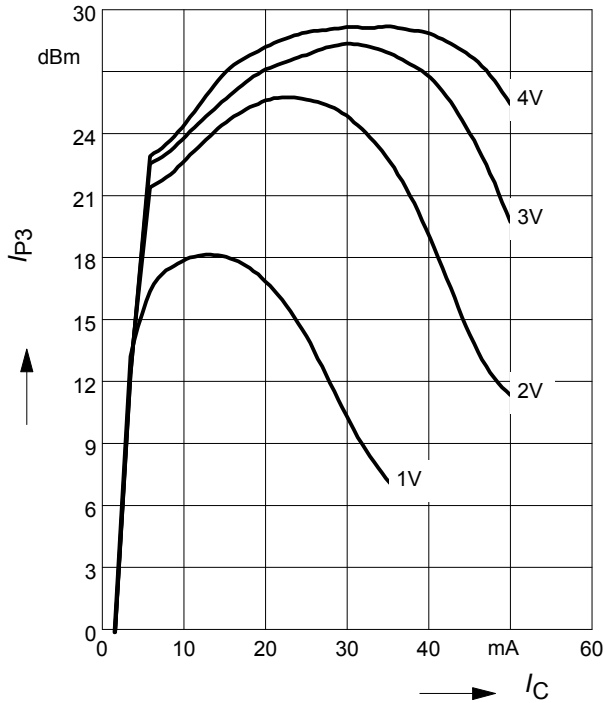

**Transition frequency  $f_T=f(I_C)$**

$f = 1$  GHz

$V_{CE}$  = parameter

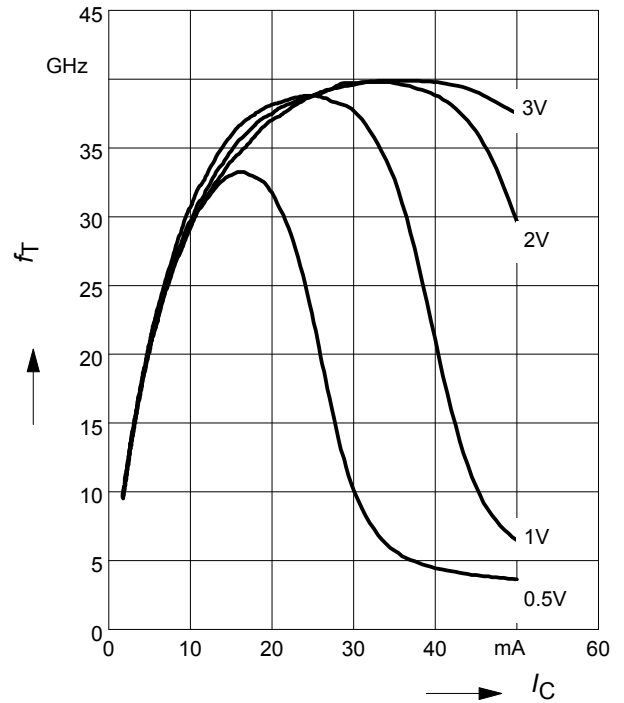

**Power gain  $G_{ma}, G_{ms} = f(I_C)$**

$V_{CE} = 3V$

$f$  = parameter

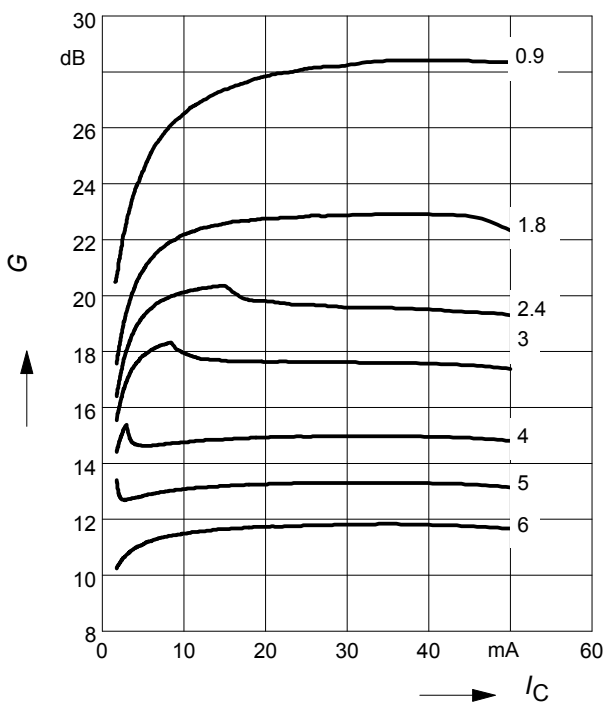

**Power Gain  $G_{ma}, G_{ms} = f(f)$**

$|S_{21}|^2 = f(f)$

$V_{CE} = 3V, I_C = 30mA$

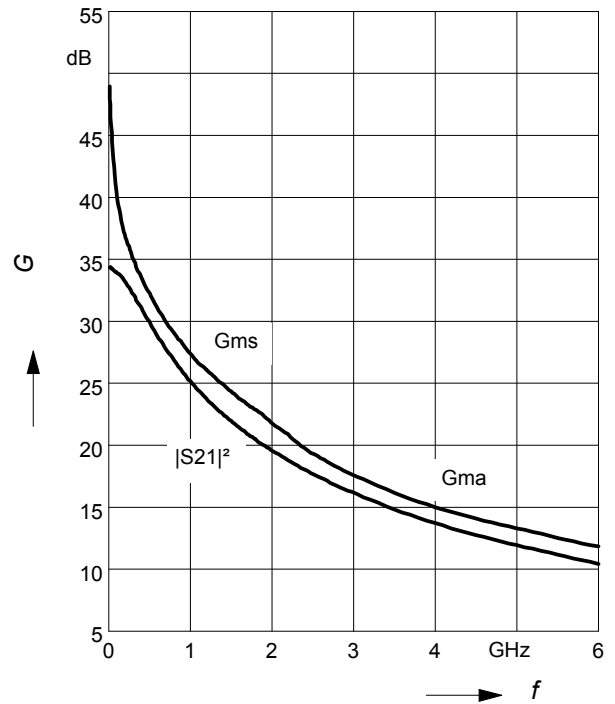

**Power gain  $G_{ma}$ ,  $G_{ms} = f(V_{CE})$**

$I_C = 30\text{mA}$

$f = \text{parameter}$

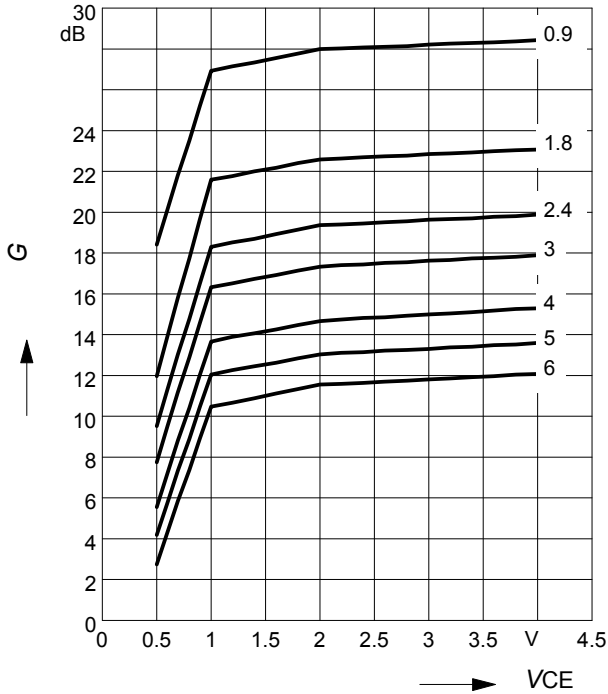

**Noise figure  $F = f(I_C)$**

$V_{CE} = 3\text{V}$ ,  $Z_S = Z_{Sopt}$

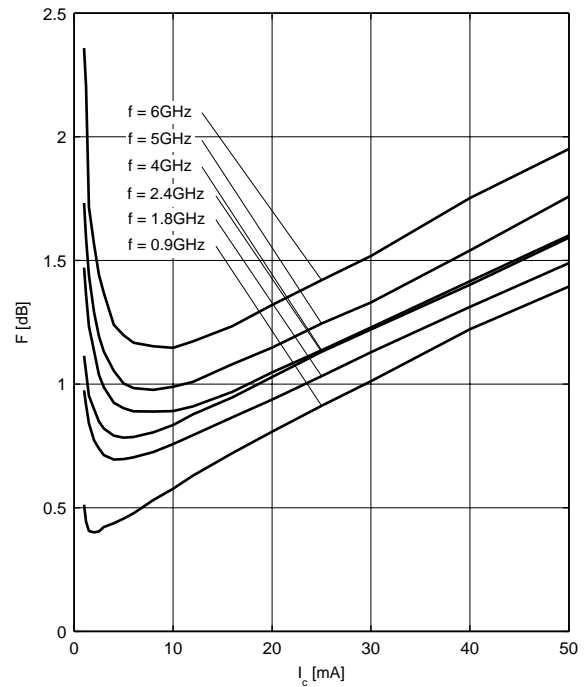

**Noise figure  $F = f(I_C)$**

$V_{CE} = 3\text{V}$ ,  $f = 1.8\text{GHz}$

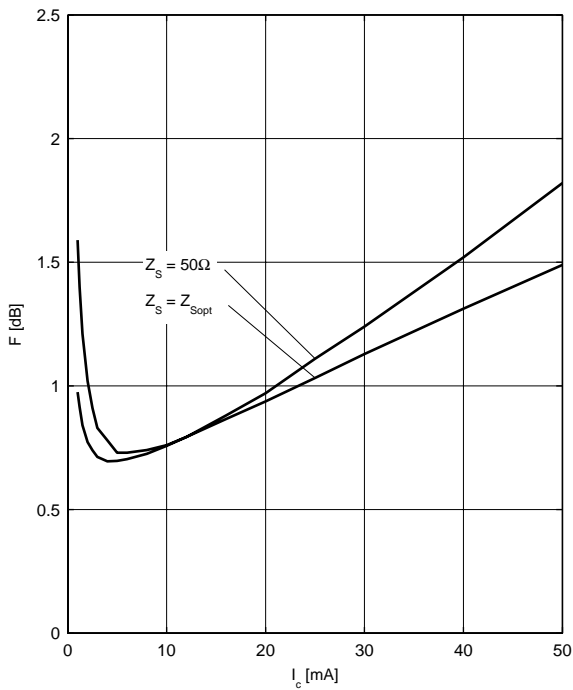

**Noise figure  $F = f(f)$**

$V_{CE} = 3\text{V}$ ,  $Z_S = Z_{Sopt}$

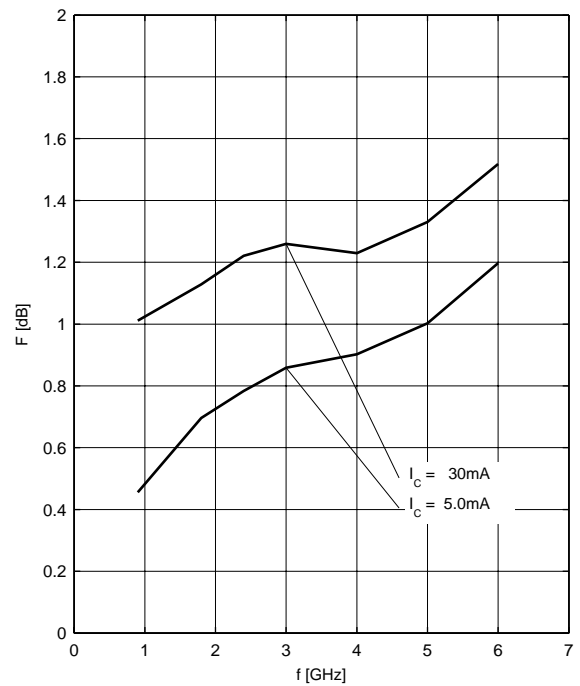

**Source impedance** for min.

noise figure vs. frequency

$V_{CE} = 3\text{ V}$ ,  $I_C = 5\text{ mA}/30\text{ mA}$

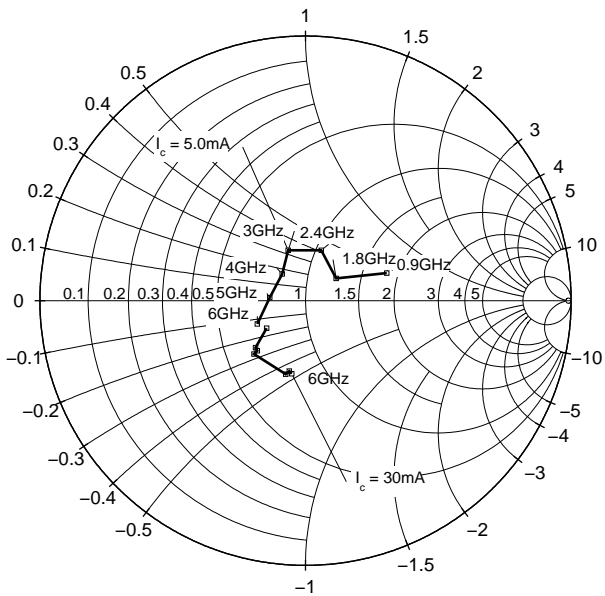



Package Outline

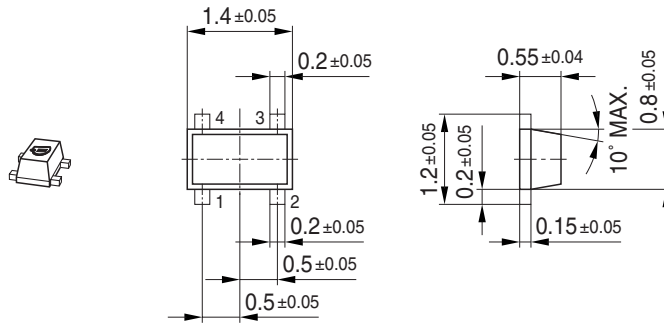

Foot Print

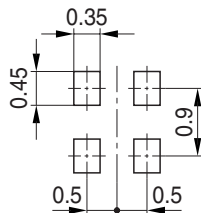

Marking Layout (Example)

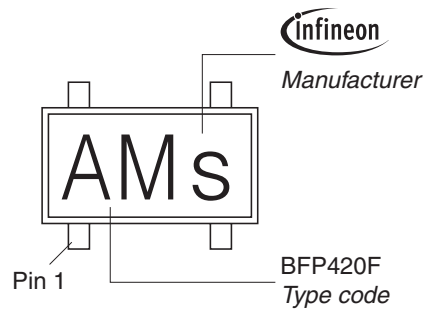

Standard Packing

Reel ø180 mm = 3.000 Pieces/Reel  
 Reel ø330 mm = 10.000 Pieces/Reel

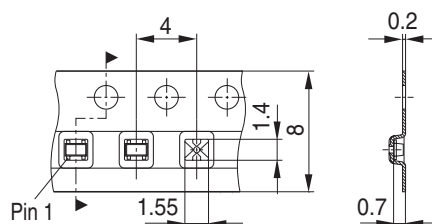

Edition 2006-02-01

Published by

Infineon Technologies AG

81726 München, Germany

© Infineon Technologies AG 2007.

All Rights Reserved.

### **Attention please!**

The information given in this dokument shall in no event be regarded as a guarantee of conditions or characteristics ("Beschaffenheitsgarantie"). With respect to any examples or hints given herein, any typical values stated herein and/or any information regarding the application of the device, Infineon Technologies hereby disclaims any and all warranties and liabilities of any kind, including without limitation warranties of non-infringement of intellectual property rights of any third party.

### **Information**

For further information on technology, delivery terms and conditions and prices please contact your nearest Infineon Technologies Office ([www.infineon.com](http://www.infineon.com)).

### **Warnings**

Due to technical requirements components may contain dangerous substances. For information on the types in question please contact your nearest Infineon Technologies Office.

Infineon Technologies Components may only be used in life-support devices or systems with the express written approval of Infineon Technologies, if a failure of such components can reasonably be expected to cause the failure of that life-support device or system, or to affect the safety or effectiveness of that device or system.

Life support devices or systems are intended to be implanted in the human body, or to support and/or maintain and sustain and/or protect human life. If they fail, it is reasonable to assume that the health of the user or other persons may be endangered.