

Description

The device provides simple and performance electronics ballast control function for the half bridge L/C resonant inverter. This device is optimized for electronics ballast requiring a minimum board area, reduced component count and low power dissipation. Internal soft start circuitry eliminates the need for an external soft start PTC resistor. The initial soft start frequency and soft start time can be easily adjusted depending on the types of lamp. Prevent burning out of switches in no lamp condition. Internal 18V regulator clamps Vcc line of supply voltage for eliminating an external zener diode.

Features

- No lamp protection
- Low Start up & Operating Current
- Internal Soft Start
- Flexible Soft Start Frequency
- Trimmed 1.5% internal Reference
- Under Voltage Lock Out with Hysteresis
- High Current Totem Pole Gate Drive

Ordering Information

Type NO.	Marking	Package Code
S6510P	S6510P	DIP-8

Outline Dimensions

unit : mm

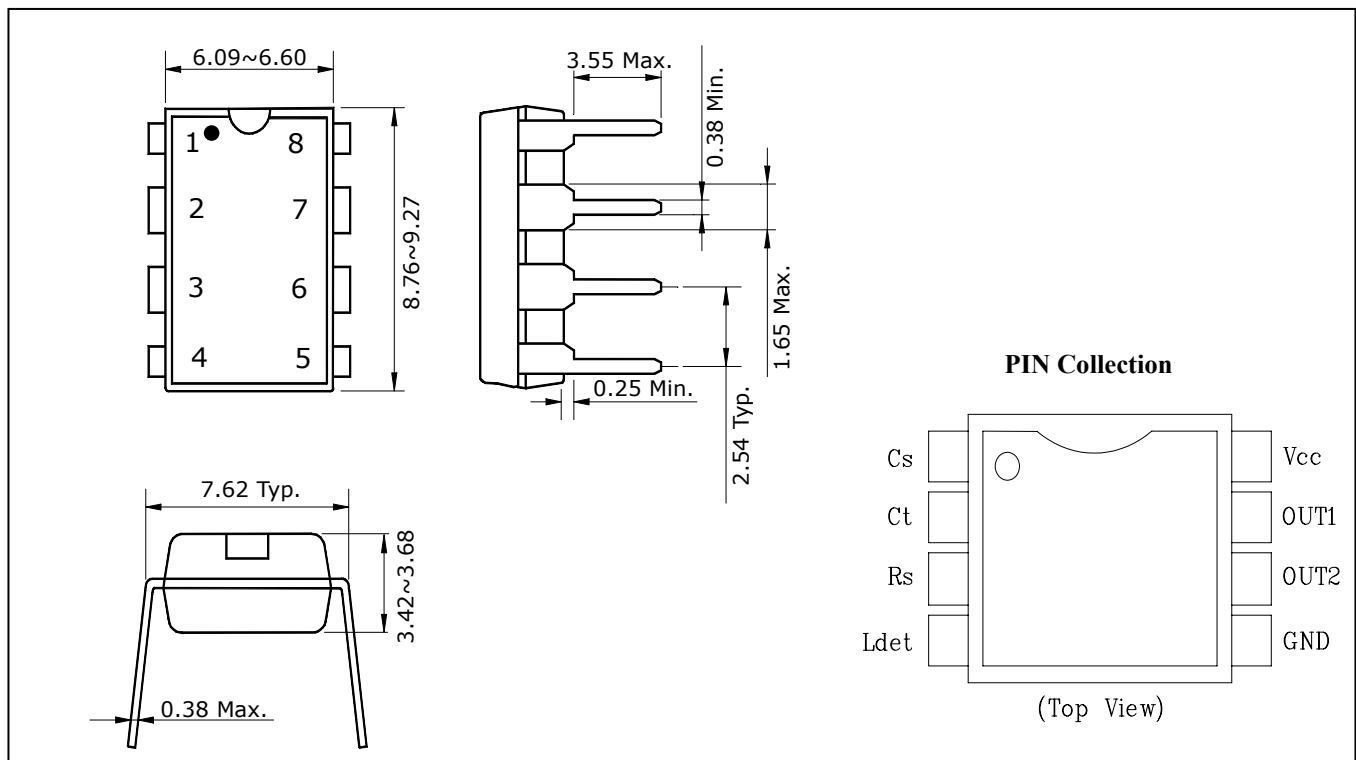

Internal Block Diagram

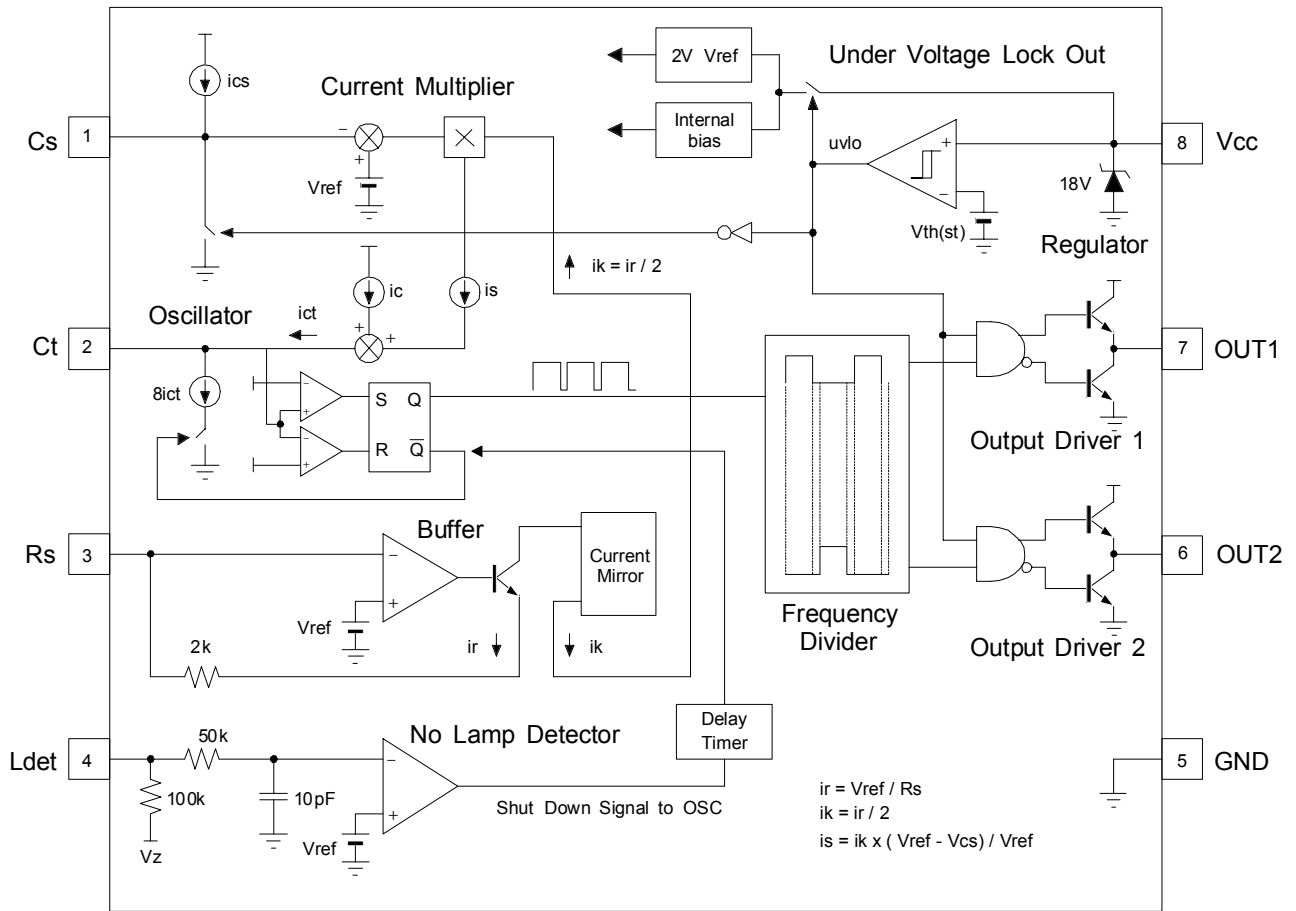

PIN Collection

Pin Number	Pin Name	Pin Function Description
1	Cs	Soft start time capacitor connection pin. The pin charge time to Vref determines The preheating time of lamp.
2	C _T	Timing capacitor connection pin. The timing capacitor is charged and discharged To generate the sawtooth waveform that determines the oscillator frequency in the internal oscillator.
3	Rs	Soft start resistor connection pin. The soft start resistor value determines the initial soft start frequency for preheating.
4	Ldet	Input to the protection circuit. If the pin voltage is lower than Vref, the output oh The output driver1,2 is inhibited.
5	GND	Ground of the control Section.
6	OUT2	Gate drive output. A push pull output stage is able to drive the Power MOSFET With peak current of 400mA.
7	OUT1	Gate drive output. A push pull output stage is able to drive the Power MOSFET With peak current of 400mA.
8	Vcc	Supply Voltage of output driver and control circuits.

ABSOLUTE MAXIMUM RATINGS

CHARACTERISTICS	SYMBOL	VALUE	UNITS
Supply Voltage	Vcc	19	V
Peak Drive Output Current	Ioh, IoI	± 400	mA
Driver Output Clamping Diodes Vo>Vcc> or Vo<-0.3V	Iclamp	± 10	mA
Soft Start and No lamp detection Input Voltage	Vin	-0.3 to 6	V
Operating temperature range	Topr	-25 to 125	°C
Storage temperature range	Tstg	-55 to 150	°C
Power Dissipation	Pd	0.8	W

Electrical Characteristics

Vcc=12V, 0°C ≤ Ta ≤ 105°C, unless otherwise stated.

Characteristic	Symbol	Test Condition	Min.	Typ.	Max.	Unit
SUPPLY VOLTAGE & CURRENT SECTION						
Start Threshold Voltage	Vth(st)	Vcc Increasing	9.5	10.5	11.5	V
UVLO Hysteresis	HT(st)	-	1.5	2.5	3.5	V
Start up Supply Current	Ist	Vcc=9V	20	50	80	μA
Operating Supply Current	Icc	Output not switching	-	3	6	mA
Dynamic Operating Supply Current	Idcc	50kHz, CI=1nF	-	5	10	mA
Supply Voltage	Vcc	Icc=30mA	17	18	19	V
ERROR AMPLIFIER SECTION						
Voltage Feedback Input Threshold	Vref	Iref=0mA, Ta=25°C	1.95	2	2.05	V
Line Regulation	ΔVref1	12V ≤ Vcc ≤ 17V	0	0.1	10	mV
Temperature Stability of Vref	ΔVref2	Temp= 0°C to 75°C	-	15	-	mV
SOFT START SECTION						
Soft start Timing Current	Ics	Cs=0V, Ct=0V	0.5	2.5	5	μA
Rs Buffer Voltage	Vrs	Rs=22K	1.9	2	2.1	V
OSCILLATOR SECTION						
Operating Frequency	* fos	Vcs=3V, Ct=470pF	43	-	49	kHz
Operating Dead Time	tod	Vcs=3V, Ct=470pF	1	1.5	2	μs
Soft Start Frequency	fss	Vcs=0V, Rs=22K	60	70	75	kHz
Initial Soft Start Dead Time	tsd	Vcs=0V, Rs=22K	0.5	1	1.5	μs

* fos rank / 1 : 43KHz ~ 47KHz, 2:45KHz ~49KHz

Electrical Characteristics

V_{cc}=12V, 0 °C ≤ T_a ≤ 105 °C, unless otherwise stated.

Characteristic	Symbol	Test Condition	Min.	Typ.	Max.	Unit
OUTPUT SECTION						
Output Voltage High	V _{oh}	I _o =-10mA	8.5	10	-	V
Output Voltage Low	V _{ol}	I _o = 10mA	-	0.5	2	V
Rising Time	t _r	C _I =1nF	-	200	-	ns
Falling Time	t _f	C _I =1nF	-	50	-	ns
Output Voltage with UVLO Activated	V _{o(uvlo)}	V _{cc} =5V, I _o =50 μA	-	-	1	V
PROTECTION SECTION						
No Lamp Detect Voltage	V _{nd}	-	1.9	2	2.1	V

Electrical Characteristic Curves

Fig. 1 Start up Supply Current vs. Supply Voltage

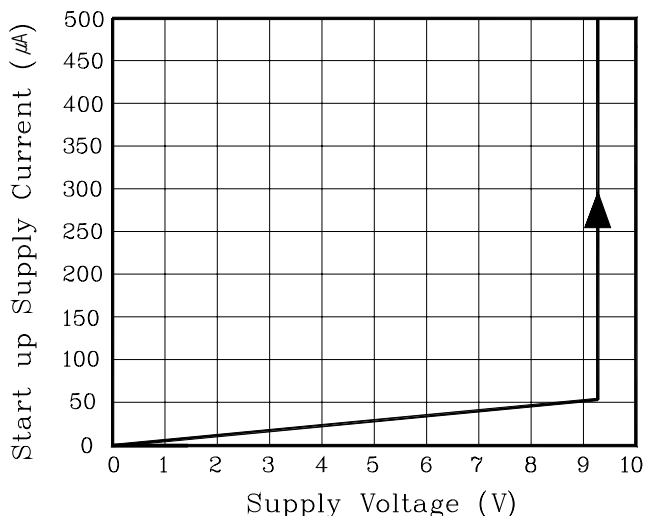

Fig. 2 Supply Current vs. Operating Supply Voltage

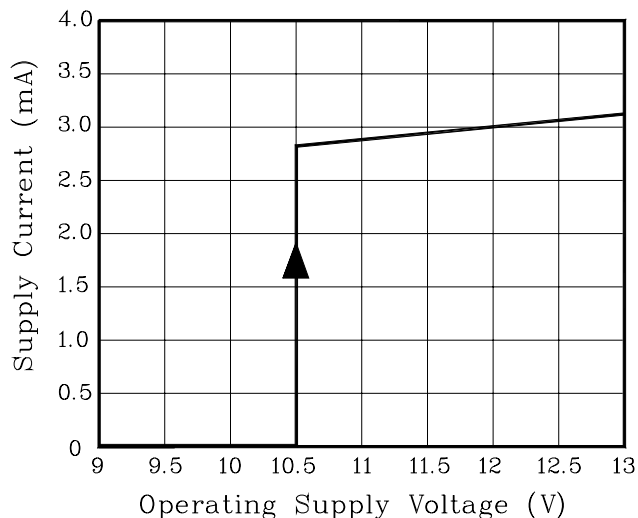

Fig. 3 Supply Current vs. UVLO Hysteresis

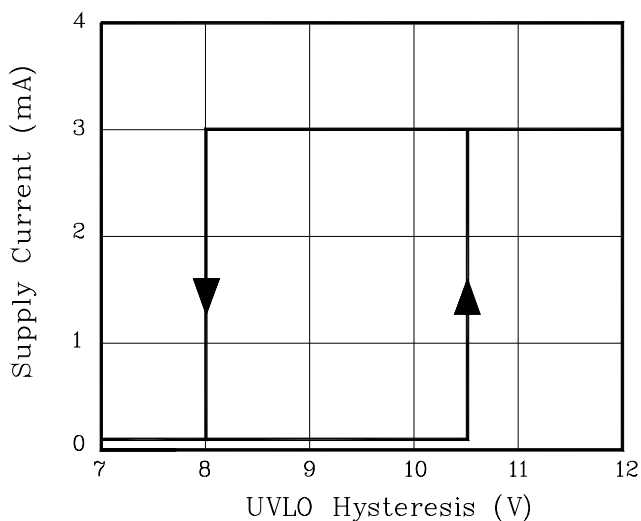

Fig. 4 Ldet Input Voltage vs. No Lamp Detect Voltage

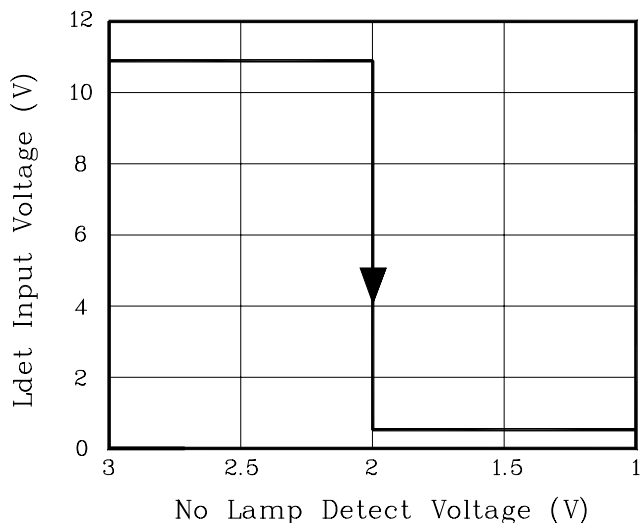

Fig. 5 Supply Current vs. Supply Voltage

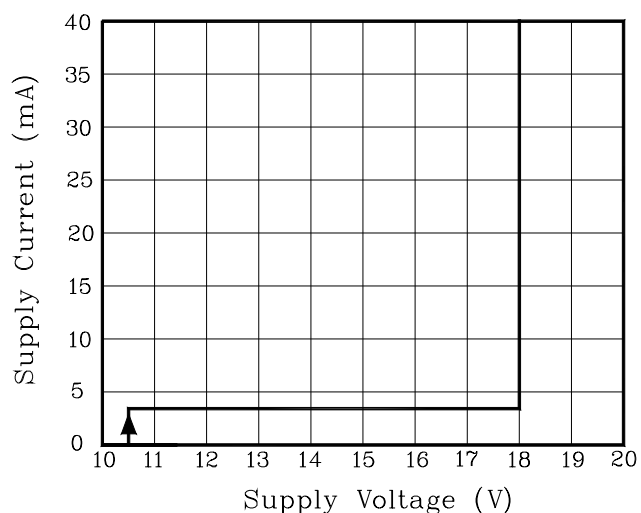
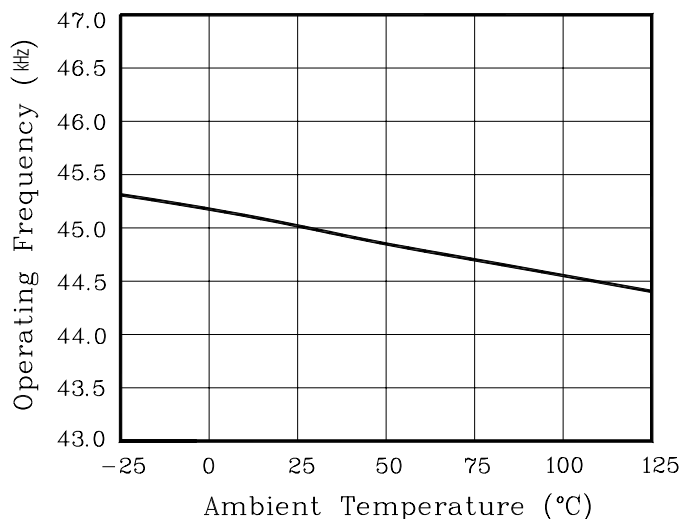

Fig. 6 Operating Frequency vs. Ambient Temperature



The AUK Corp. products are intended for the use as components in general electronic equipment (Office and communication equipment, measuring equipment, home appliance, etc.).

Please make sure that you consult with us before you use these AUK Corp. products in equipments which require high quality and / or reliability, and in equipments which could have major impact to the welfare of human life(atomic energy control, airplane, spaceship, transportation, combustion control, all types of safety device, etc.). AUK Corp. cannot accept liability to any damage which may occur in case these AUK Corp. products were used in the mentioned equipments without prior consultation with AUK Corp..

Specifications mentioned in this publication are subject to change without notice.