

AS3492

Highly Efficient 2-10 LEDs Backlight Driver with 2 PWM Inputs

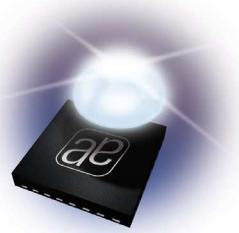

1 General Description

The AS3492 is an inductive highly efficient DCDC boost converter. The DCDC converter operates at a fixed frequency of 2MHz and includes soft startup to allow easy integration into noise sensitive RF systems. A predictable startup is guaranteed even with very low duty cycle PWM input signals. The voltage on the output capacitor is controlled to minimize ripple and to avoid any acoustic effects for low frequency PWM input signals.

The output of the DCDC converter is used for five current sources connected to up to 10 LEDs. If a current source is not required, it shall be connected to VOUT or GND - the AS3492 detects this condition and disables this current source automatically; this keeps the efficiency of the system constantly high.

The AS3492 is controlled by two enable inputs, ON13 and ON45. These inputs can also be used to connect a PWM input (like DLS or DBC).

The AS3492 includes several protection functions like undervoltage lockout, overcurrent and overtemperature.

No microvias are required to assemble the AS3492 if only four channels are used and ON13=ON45.

The AS3492 is available in a space-saving WL-CSP package measuring only 1.7x1.4x0.5mm and operates over the -30°C to +85°C temperature range.

Figure 1. AS3492 Typical Operating Circuit

2 Key Features

- 2 MHz DCDC Boost converter
 - Small 4.7µH external coil
 - Very high system efficiency of 86% (DCDC and current sources combined)
 - Very low voltage changes on output to avoid acoustic noise on output capacitor even with PWM
 - Smooth startup even under low duty cycle PWM conditions
- Five Current sources up to 25mA
 - Low voltage compliance (150mV)
 - High side current source to simplify layout and thermal management of the LEDs
 - Automatically detect and disable failing or not used LEDs to keep efficiency high
 - Current matching <4%
 - Current accuracy <7.5%
- Excellent LED current output ripple <500µA
- Support DLS (Dynamic Luminance Scaling or DBC)
- Undervoltage lockout and overcurrent protection
- Overtemperature protection
- Available in a tiny WL-CSP package
 - 3x4 balls, 0.4mm pitch, 1.7x1.4x0.5mm

3 Applications

Display backlight driver for mobile phones, digital cameras, PND and PMPs.

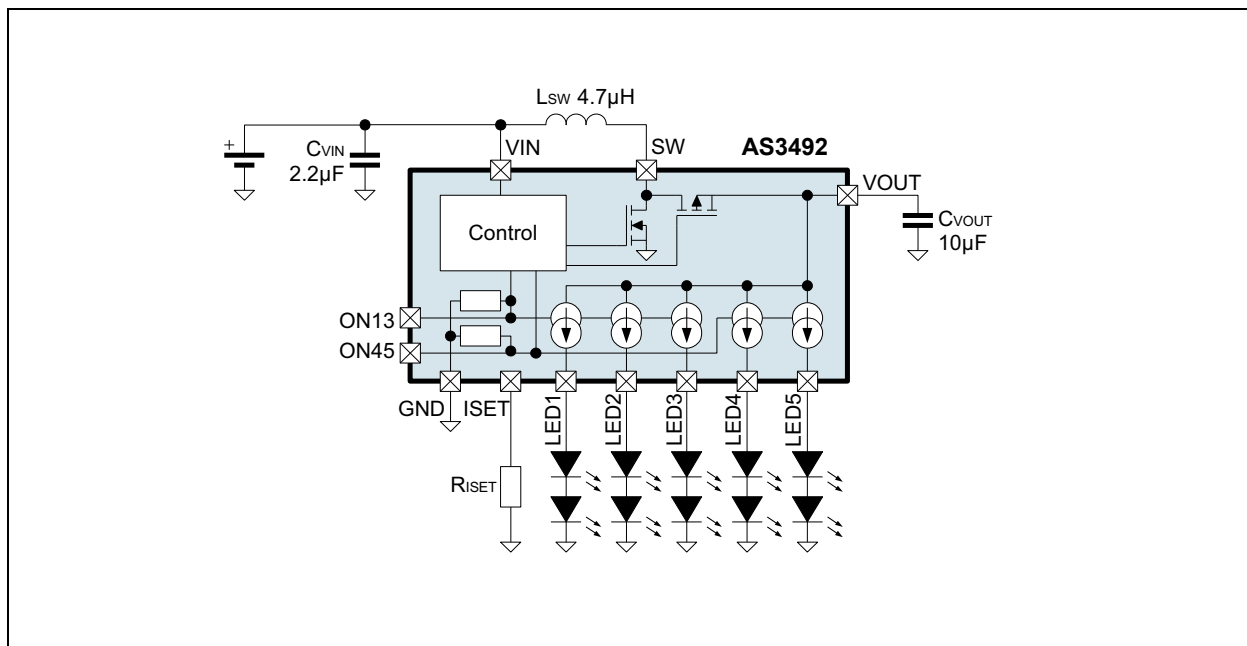

4 Pinout

Pin Assignment

Figure 2. Pin Assignments (Top View)

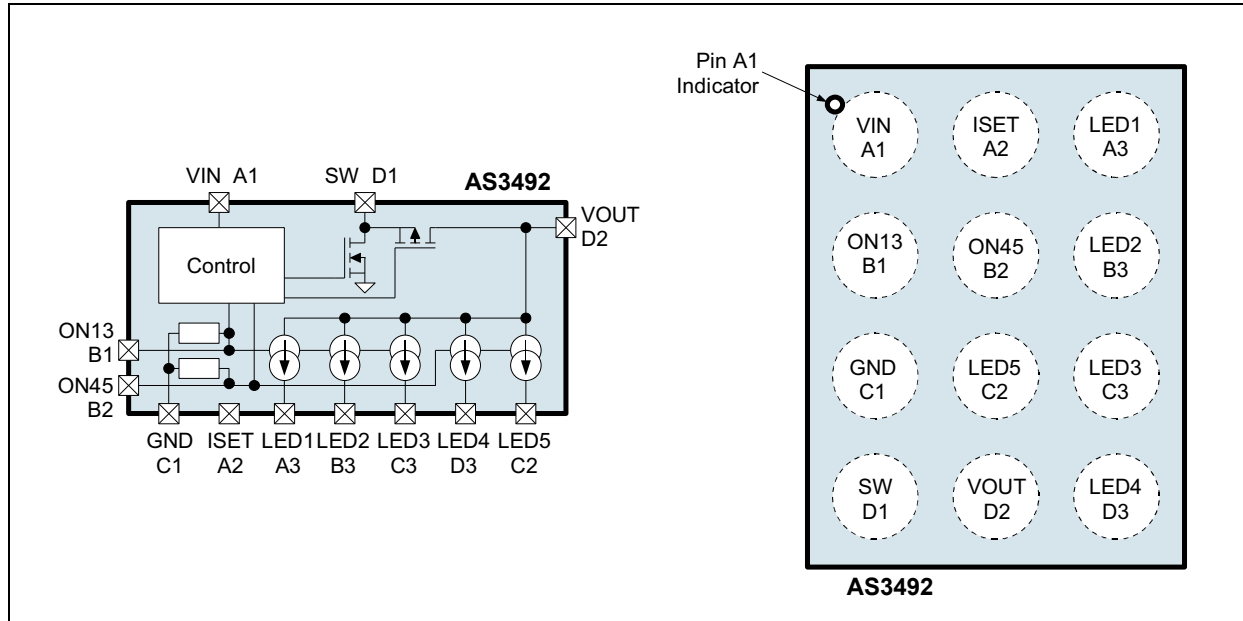

Pin Description

Table 1. WL-CSP12 Pin Description

Pin Number	Pin Name	Description
A1	VIN	Positive supply voltage input - connect to supply and make a short connection to input capacitor C _{VIN}
A2	ISET	External current set resistor, forced to 1.25V in operation - LED current typically 400xISET current
A3	LED1	Current source output 1 - controlled by ON13
B1	ON13	Digital input pin - enable input active high for current sources D1...D3 ¹
B2	ON45	Digital input pin - enable input active high for current sources D4...D5 ^{1,2}
B3	LED2	Current source output 2 - controlled by ON13
C1	GND	Supply ground - connect to supply and make a short connection to input capacitor C _{VIN} and C _{VOUT}
C2	LED5	Current source output 5 - controlled by ON45
C3	LED3	Current source output 3 - controlled by ON13
D1	SW	DCDC converter switching node
D2	VOUT	DCDC converter output - make a short connection to capacitor C _{OUT}
D3	LED4	Current source output 4 - controlled by ON45

1. If ON13 and ON45 are low, the AS3492 enters shutdown.

5 Absolute Maximum Ratings

Stresses beyond those listed in [Table 2](#) may cause permanent damage to the device. These are stress ratings only, and functional operation of the device at these or any other conditions beyond those indicated in [Table 3, "Electrical Characteristics," on page 4](#) is not implied. Exposure to absolute maximum rating conditions for extended periods may affect device reliability.

Table 2. Absolute Maximum Ratings

Parameter	Min	Max	Units	Comments
VIN, ON13, ON45 and ISET to GND	-0.3	+7.0	V	
ON13, ON45 and ISET to VIN		+0.3	V	internal protection diodes to VIN
SW, VOUT, LED1...LED5 to GND	-0.3	11	V	
SW, LED1...LED5 to VOUT		+0.3	V	internal protection diodes to VOUT
Input Pin Current without causing latchup	-100	+100 +IIN	mA	Norm: EIA/JESD78
Continuous Power Dissipation (TA = +70°C)				
Continuous power dissipation		870	mW	PT ¹ at TAMB=70°C
Continuous power dissipation derating factor		11.67	mW/°C	PDERATE ²
Electrostatic Discharge				
ESD HBM		±2000	V	Norm: JEDEC JESD22-A114F
ESD CDM		±500	V	Norm: JEDEC JESD 22-C101E
ESD MM		±100	V	Norm: JEDEC JESD 22-A115-B
Temperature Ranges and Storage Conditions				
Junction Temperature		+125	°C	
Storage Temperature Range	-55	+125	°C	
Humidity	5	85	%	Non condensing
Body Temperature during Soldering		+260	°C	according to IPC/JEDEC J-STD-020
Moisture Sensitivity Level (MSL)	MSL 1			Represents a max. floor life time of unlimited

1. Depending on actual PCB layout and PCB used
2. PDERATE derating factor changes the total continuous power dissipation (PT) if the ambient temperature is not 70°C. Therefore for e.g. TAMB=85°C calculate PT at 85°C = PT - PDERATE * (85°C - 70°C)

6 Electrical Characteristics

$V_{VIN} = +2.5V$ to $+5.5V$, $T_{AMB} = -30^{\circ}C$ to $+85^{\circ}C$, unless otherwise specified. Typical values are at $V_{VIN} = +3.7V$, $T_{AMB} = +25^{\circ}C$, unless otherwise specified.

Table 3. Electrical Characteristics

Symbol	Parameter	Condition	Min	Typ	Max	Unit
General Operating Conditions						
V_{VIN}	Supply Voltage		2.5	3.7	5.5	V
$V_{VIN_REDUCED}$	Supply Voltage reduced performance	not all parameters within specification	2.3			V
$I_{SHUTDOWN}$	Shutdown Current	ON13=0V, ON45=0V		0.5	2.0	μA
I_{VIN}	Operating Current	no load, PWM Normal mode		250		μA
T_{AMB}	Operating Temperature		-30	25	85	$^{\circ}C$
DCDC Converter parameters						
V_{VOUT}	Output Voltage V_{OUT}	automatically regulated	$V_{VIN}+0.3V$		V_{VOUT_MAX}	V
		all other conditions with ON13=ON45			140	
$V_{VOUT_RIPPLE_PWM}$	Voltage V_{OUT} due to PWM signal	identical signal for ON13 and ON45; DCDC not in pulseskip or current limit		70		mV
I_{LOAD}	Load current	$V_{OUT} < 7.5V$	0.0		100	mA
η	Overall Efficiency	$V_{VIN}=3.7V$, $T_{AMB} = +25^{\circ}C$, LED mismatch $\leq 30mV$, $V_{LED}=3.0V$				%
		$I_{LOAD}=50mA$		86		
		$I_{LOAD}=75mA$	85	86		
		$I_{LOAD}=100mA$		86		
f_{CLK}	Operating Frequency	All internal timings are derived from this oscillator	-10%	2.0	+10%	MHz
t_{MIN_ON}	Minimum on-time			60		ns
MDC	Maximum Duty Cycle			90		%
R_{SW_P}	DCDC Switch SW - V_{OUT}			0.5		Ω
R_{SW_N}	DCDC Switch SW - GND			0.5		Ω
Output voltage soft start						
t_{VOUT_START}	softstart time	measured from first high signal on ON13 or ON45		1.2		ms
V_{VOUT_START}	V_{OUT} startup voltage			7.0		V
$t_{PWM_START_MAX}$	Startup with PWM	Maximum duration between PWM pulses during startup; see Figure 17 on page 11	10	11	12	ms
$t_{TIMEOUT}$	DCDC timeout time	if ON13 and ON45=0 for $t_{TIMEOUT}$, the DCDC is stopped and the AS3492 enters shutdown	29		48	ms
Current Sources						
$V_{LED1..5}$	LED1...LED5 output voltage range		2.6 x2	3.3 x2	3.9 x2	V
$I_{LED1..5}$	LED1...LED5 output current range		0.0		25.0	mA
$I_{LED1..5\Delta}$	LED1...LED5 current source accuracy ¹	$I_{LED1..5} = 20mA$	-7.5		+7.5	%

Table 3. Electrical Characteristics (Continued)

Symbol	Parameter	Condition	Min	Typ	Max	Unit
I _{LED1..5} MATCH	LED1...LED5 current source matching	I _{LED1..5} = 20mA	-4.0		+4.0	%
I _{LED1..5} RIPPLE	LED1...LED5 ripple current	BW=10MHz	I _{LED} > 5mA		10	% of I _{LED}
			I _{LED} < 5mA		500	µA
I _{LED1..5} PWMLIN	LED1...LED5 linearity ²	I _{LED} =20mA, PWM frequency 300Hz	PWM>=25/255	-2	+2	%
			25/255> PWM>=1/255	-10	+10	%
f _{PWM}	PWM input frequency	on pin ON13 or ON45	100	300	800	Hz
I _{LED1..5} LEAKAGE	LED1...LED5 leakage current	current source off, T _{AMB} < +50°C	-0.5	0	+0.5	µA
V _{I_{LED}_COMP}	LED1...LED5 current source voltage compliance	Minimum voltage between pin V _{OUT} and LED1...LED5, I _{LED} <20mA ³	100			mV
Current Reference (pin ISET)						
V _{ISET}	ISET voltage			1.25		V
I _{LED2ISET}	LED current to ISET current			400		A/A
Protection Functions (see page 12)						
V _{VOUT_MAX}	V _{OUT} overvoltage protection		8.6		10.0	V
V _{VOUT_OPE_NLED}	V _{OUT} open LED detection threshold	Voltage level on V _{OUT} where open LED detection is performed	8.0	8.5	8.8	V
V _{I_{LED}_OPEN}	V _{I_{LED}1..5} open detection	an open LED is assumed if the voltage on the current source is less than V _{I_{LED}_OPEN} and V _{OUT} =V _{VOUT_OPENLED}		92	125	mV
V _{I_{LED}_SHORT}	V _{I_{LED}1..5} short detection	voltage on LED1..5 where a shorted LED is assumed		0.95		V
t _{I_{LED}_ERROR_DEB_OPEN}	V _{I_{LED}1..5} open debounce time	Open LED detection debounce time			4.8	µs
t _{I_{LED}_ERROR_DEB_SHORT}	V _{I_{LED}1..5} short debounce time	Short LED detection debounce time ⁴			9.0	µs
I _{LIMIT}	Current Limit for coil LSW (Pin SW)		510	600	685	mA
T _{OVTEMP}	Overtemperature Protection	Junction temperature		144		°C
T _{OVTEMPHYST}	Overtemperature Hysteresis			5		°C
V _{VVLO}	Undervoltage Lockout	Falling V _{VIN}	1.8	1.9	2.1	V
		Rising V _{VIN}	V _{VVLO} +0.05	2.2	2.3	V
Digital Interface						
V _{I_H}	High Level Input Voltage		1.07		V _{VIN}	V
V _{I_L}	Low Level Input Voltage		0.0		0.68	V
R _{PULLDOWN}	Pulldown resistor	1.8V on pad	90	250		kΩ

1. Excluding variation of external resistor R_{ISET}; voltage difference between any set of drivers less than 200mV

2. Note: It is not recommended to operate the current sources at minimum duty cycle with low LED currents.
3. The dcdc output voltage VOUT is regulated to 150mV above the maximum LED voltage (LED1...LED5) to guarantee proper operation of the current with output voltage ripple and undershoots (e.g. due to PWM or supply voltage changes)
4. The short LED detection debounce time is longer than the open LED detection debounce time to allow the parasitic capacitance of the LED to charge above VLED_SHORT within this time and avoid wrong triggering of short LED detection.

7 Typical Operating Characteristics

V_{BAT} = 3.7V, T_A = +25°C (unless otherwise specified).

Figure 3. DCDC Efficiency vs. V_{BAT}

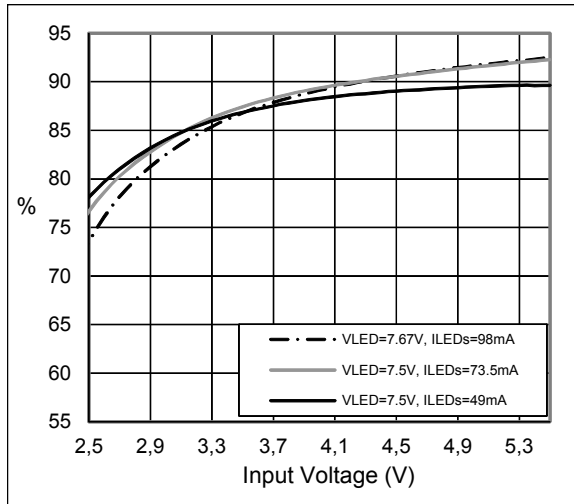

Figure 4. LED Efficiency vs. V_{BAT}

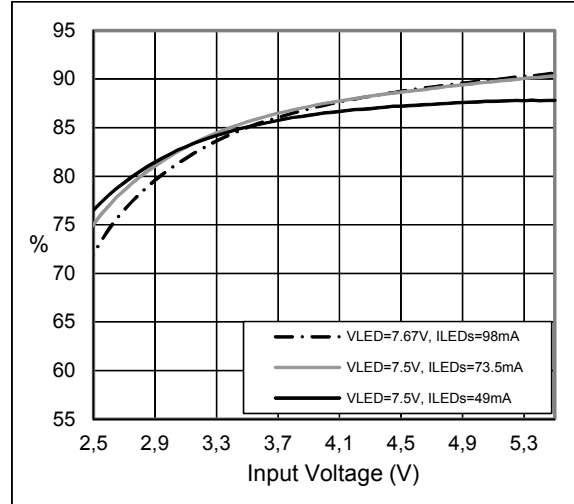

Figure 5. Efficiency vs. Load Current

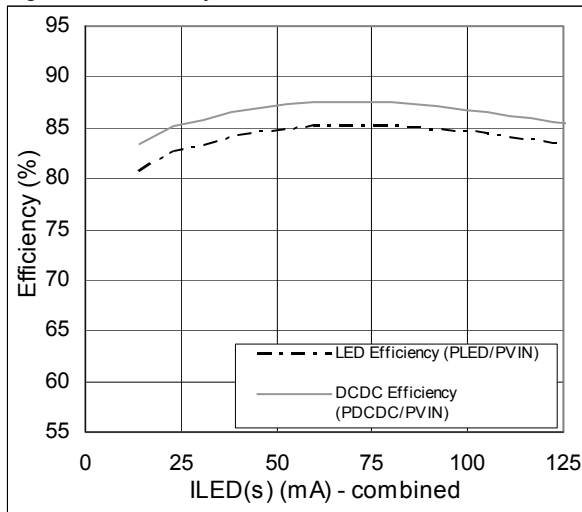

Figure 6. Startup with PWM, 20% duty cycle

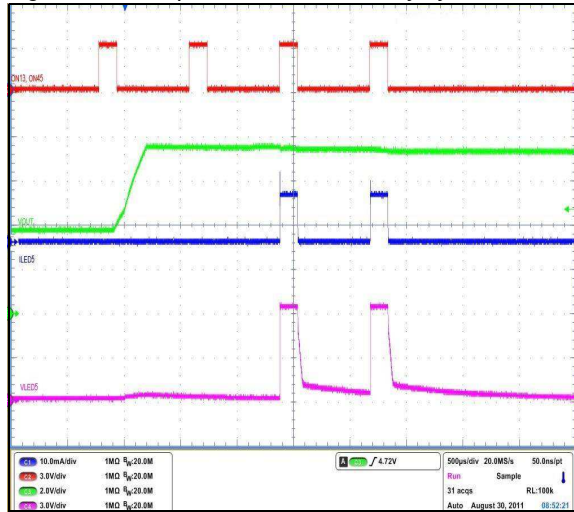

Figure 7. Startup with PWM, 70% duty cycle

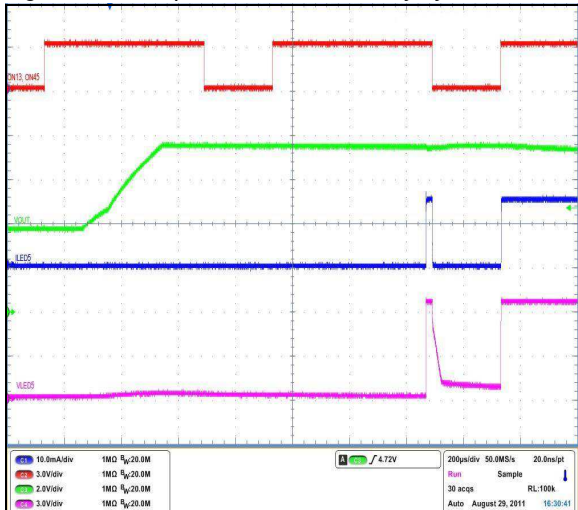

Figure 8. DCDC Switching Waveforms

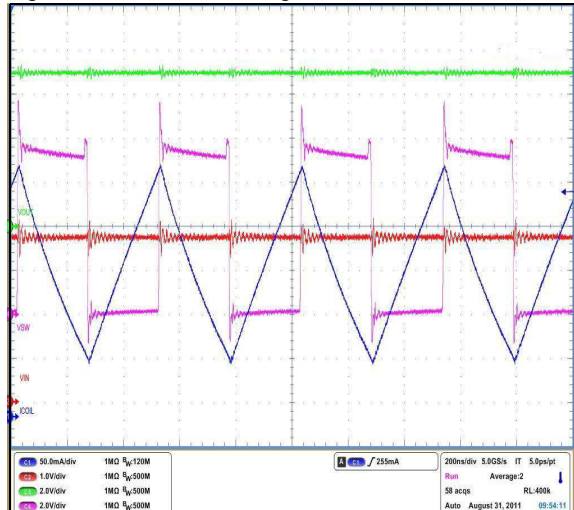

Figure 9. Open LED Detection Waveform

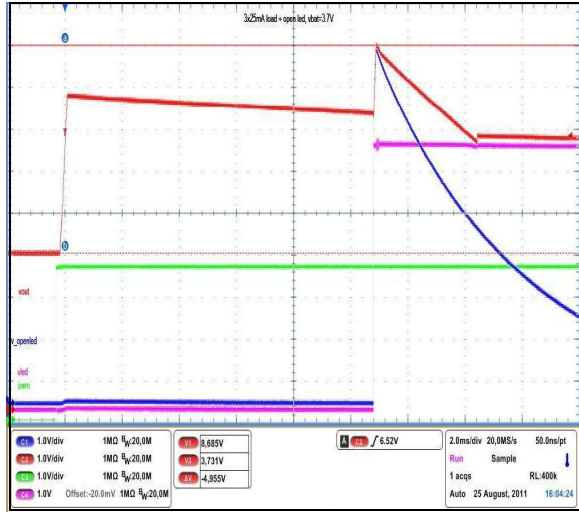

Figure 10. VIN line transient 10μs (LOAD=100mA)

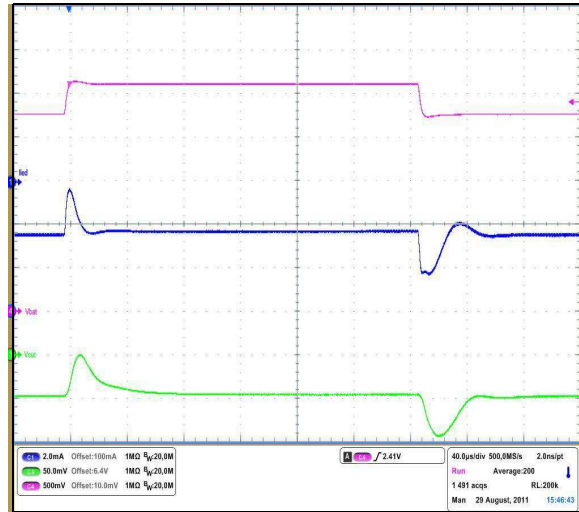

Figure 11. VOUT ripple with PWM

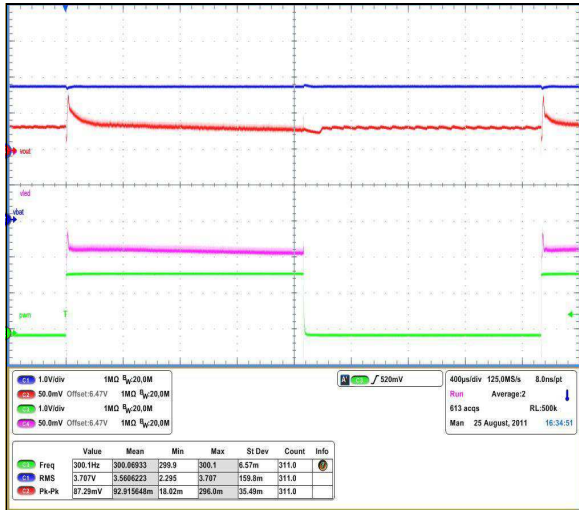

Figure 12. ILED ripple (ILOAD=100mA)

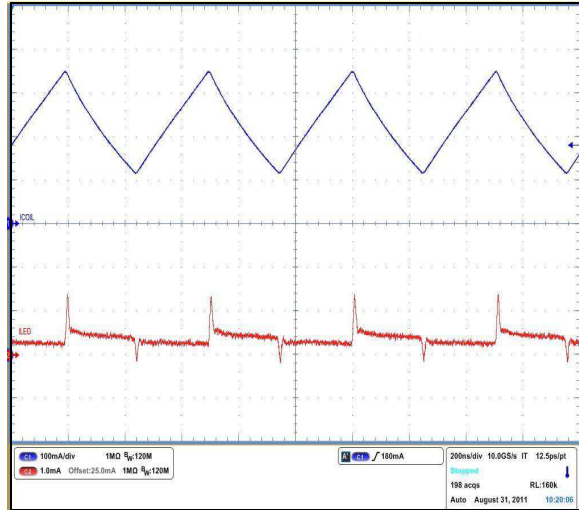

Figure 13. ILED vs. RISET

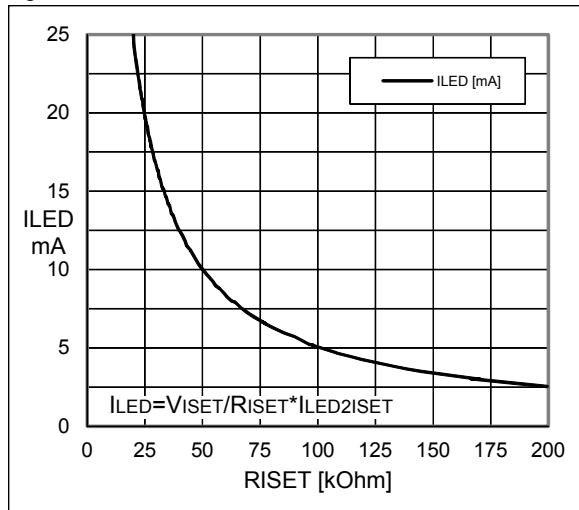

Figure 14. fosc vs. VIN

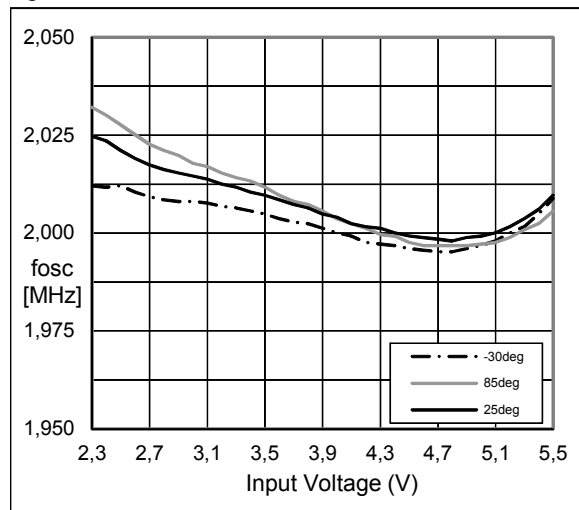
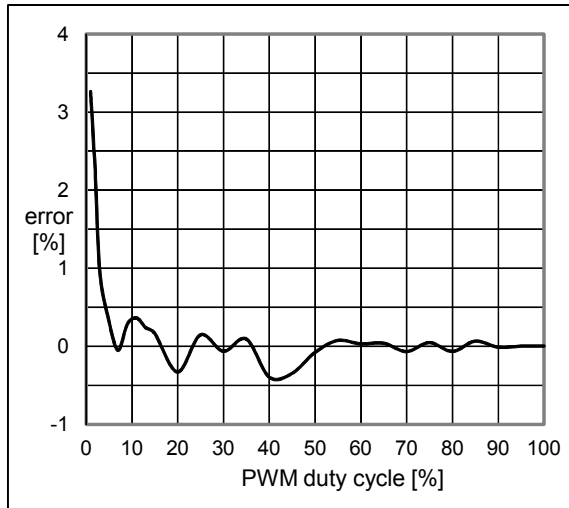

Figure 15. Current Error vs. duty cycle ($I_{LED}=25mA$)

8 Detailed Description

The AS3492 is a high performance DCDC step up converter and five current sources in a small WL-CSP12 package.

The LED configuration is done in up to five strings¹, each strings using two LEDs in series². This configuration results in excellent application efficiency even using very small external components (capacitors and coil). The device is controlled by ON13 and ON45. A high levels on these inputs enables the DCDC and the current sources. ON13 and ON45 can be used as PWM inputs³ to accurately control the LED brightness.

The target application is to use the AS3492 for highly efficient backlight driver (display and/or keypad backlight).

Internal Circuit

Figure 16. AS3492 internal circuit

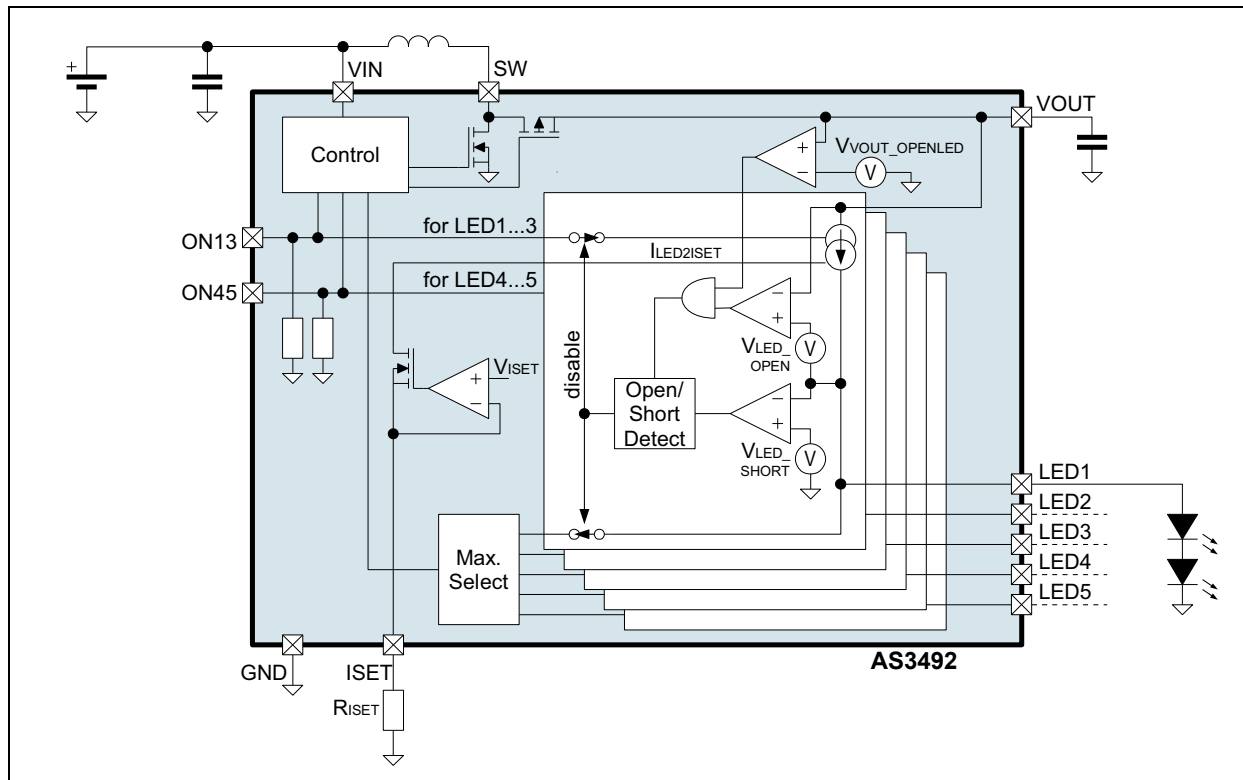

The AS3492 includes a fixed frequency DCDC step-up with accurate startup control. It is enabled by the input pin ON13 and ON45 and controls the LED current with five current sources. These input can be used as PWM inputs to control the brightness in two groups:

- a high level on ON13 enables LED1, LED2 and LED3
- a high level on ON45 enables LED4 and LED5.

The current is adjustable by an external resistor R_{SET} .

1. Unused strings shall be connected to VOUT or GND.
2. Single LED strings can be mixed with dual LED strings as long as each of the two groups (LED1...LED3, LED4...LED5) has at least one string with two LEDs in series - it will reduce application efficiency.
3. Using the PWM inputs, the AS3492 supports DLS, dynamic luminance scaling, also called CABC, content adaptive backlight control or DBC, dynamic backlight control.

Startup

In order to avoid inrush-current during startup the supplies are smoothly ramped up according to [Figure 17](#) even under low PWM duty cycle conditions. This allows the easy integration into mobile battery powered systems:

Figure 17. Startup Procedure

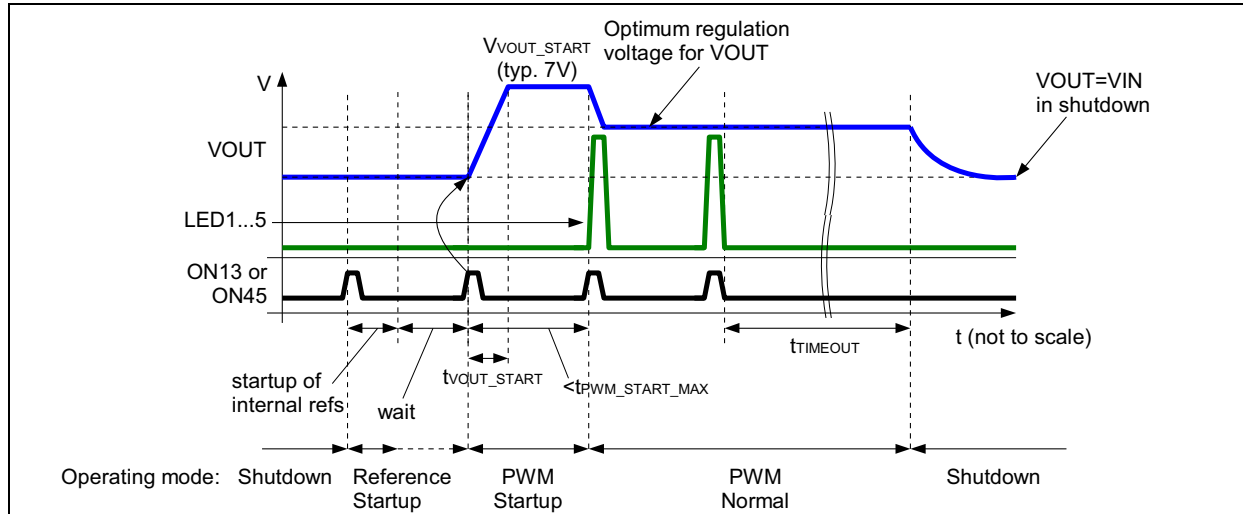

Open and short LED detection

After the startup is finished, the AS3492 continuously monitors open and shorted LEDs. If an open or shorted LED string is detected, this LED string is disabled and the driver continues its normal operation. The driver is disabled to keep the efficiency of AS3492 for different LED configurations high. The error is cleared once the AS3492 enters shutdown⁴.

Shorted LED

After startup is finished, for any LED, enabled by the inputs ON13 or ON45, is below V_{LED_SHORT} , for at least $t_{LED_ERROR_DEB_SHORT}$, a shorted LED is assumed.

Open LED

LED outputs (LED1...LED5) which are not used by the application shall be connected permanently to VOUT or GND. The AS3492 detects this condition upon startup and automatically disables the current sources for these LEDs - see [Figure 18](#) and [Figure 19](#), immediately after the rising edge of ON13 or ON45.

For LEDs, which are open during operation of the device, following procedure of the AS3492 is used for detection:

After startup is finished, if the voltage on $V_{OUT}=V_{V_{OUT_OPENLED}}$ ⁵ and the voltage across any current source, enabled by the inputs ON13 or ON45, is below V_{LED_OPEN} ($V_{OUT-LED1...5}$), for at least $t_{LED_ERROR_DEB_OPEN}$, an open LED is assumed.

[Figure 18](#) shows the waveform for the detection of a single open LED, [Figure 19](#) for all LEDs open.

4. The error is automatically cleared as the open/short LED error might be temporarily (e.g. bouncing of the connections to the LED)
5. If the current limit of the coil (I_{LIMIT}) is reached before $V_{OUT}=V_{V_{OUT_OPENLED}}$, an open LED is not detected.

Figure 18. Single Open LED detection

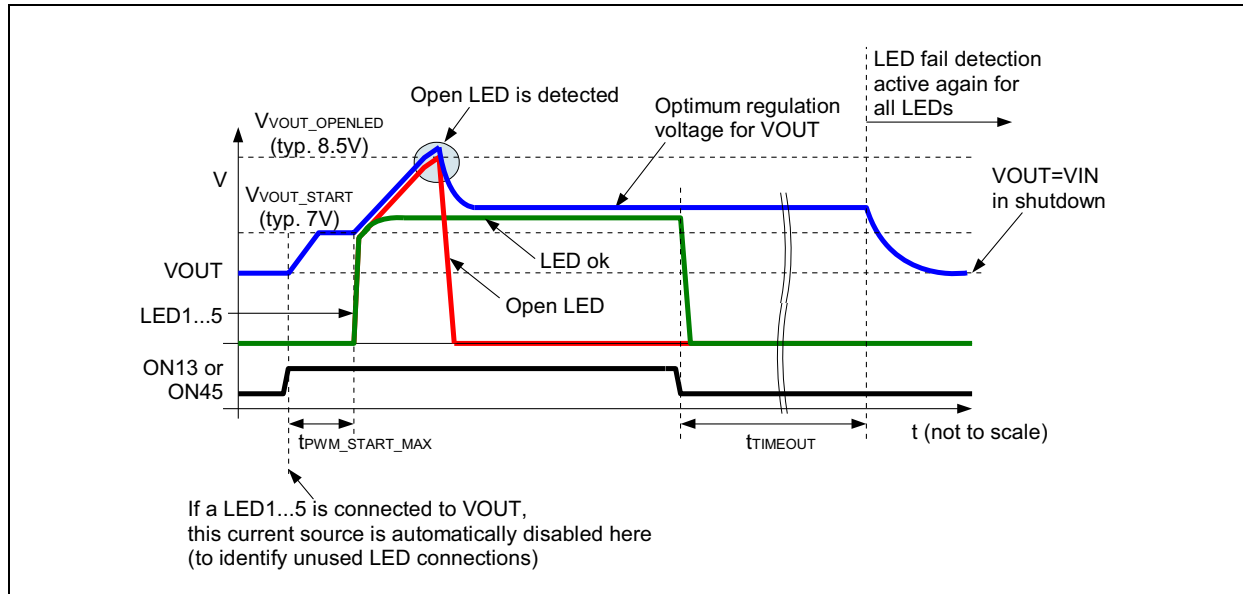
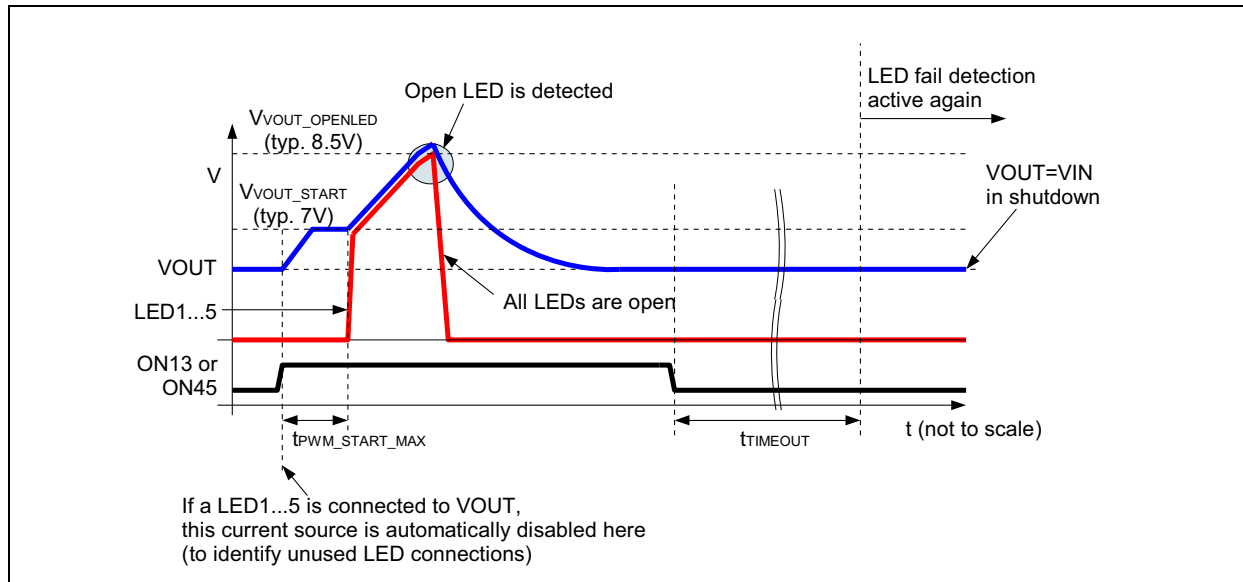

Figure 19. All LEDs open



Protection and Fault Detection Functions

The protection functions protect the AS3492, its external components and connected LEDs against physical damage.

Overvoltage Protection

The voltage on VOUT is kept below or at V_{VOUT_MAX} under every operating condition⁶. If the voltage on VOUT is at V_{VOUT_MAX} for more than 70ms⁷, the DCDC will shutdown. It can be re-enabled by setting ON13 and ON45 to low for more than $t_{TIMEOUT}$.

6. When reaching $V_{OUT}=V_{VOUT_OPENLED}$, the open LED detection is performed.

7. The duration can vary from 55ms to 85ms within a single AS3492.

DCDC Inductor Peak Current Limitation

To limit the maximum current from the battery, the DCDC converter limits its current through the coil to I_{LIMIT} on a cycle by cycle basis.

Overtemperature Protection

The junction temperature of the AS3492 is continuously monitored. If the temperature exceeds T_{OVTEMP} , the DCDC is stopped. The driver is automatically re-enabled once the junction temperature drops below $T_{OVTEMP} - T_{OVTEMPHYST}$.

Supply undervoltage Protection

If the voltage on the pin VIN is or falls below V_{UVLO} , the AS3492 is kept in shutdown.

9 Application Information

External Components

Input Capacitor C_{VIN}

Low ESR input capacitors reduce input switching noise and reduce the peak current drawn from the battery. Ceramic capacitors are required for input decoupling and should be located as close to the device as is practical.

Table 4. Recommended Input Capacitor

Part Number	C	TC Code	ESR	Rated Voltage	Size	Manufacturer
GRM155R60J225ME15	2.2 μ F +/-20%	X5R		6V3	0402 (1.0x0.5x 0.5mm)	Murata www.murata.com
GRM155R60J155M--D	1.5 μ F	X5R		6V3		
ECJ0MBFJ185V		X5R			0402 (1.0x0.5x 0.5mm)	Panasonic Matsushita www.panasonic.com
JDK105BJ155MVNF		X5R			0402 (1.0x0.5x 0.5mm)	Taiyo Yuden www.taiyo-yuden.com

If a different input capacitor is chosen, ensure similar ESR value and at least 0.6 μ F capacitance at the maximum input supply voltage. Larger capacitor values (C) may be used without limitations.

Output Capacitors C_{OUT}

Low ESR capacitors should be used to minimize V_{OUT} ripple. Multi-layer ceramic capacitors are recommended since they have low ESR and are available in small footprints. The capacitor should be located as close to the device as is practical.

X5R dielectric material is recommended due to their ability to maintain capacitance over wide voltage and temperature range.

Table 5. Recommended Output Capacitor C_{OUT}

Part Number	C	TC Code	ESR	Rated Voltage	Size	Manufacturer
GRM219R61A116UE82L	10 μ F	X5R	120m Ω	10V	0805 (2x1.25x 0.85mm)	Murata www.murata.com
LDK212BJ106MDNT	10 μ F	X5R		10V	0805 (2x1.25x 0.85mm)	Taiyo Yuden www.taiyo-yuden.com

If a different output capacitor is chosen, ensure similar ESR values and at least 4.2 μ F @ 5.6V and maximum 20 μ F capacitance.

Inductor L_{SW}

The fast switching frequency (2MHz) of the AS3492 allows for the use of small SMDs for the external inductor. The inductor should have low DC resistance (DCR) to reduce the I^2R power losses - high DCR values will reduce efficiency.

Table 6. Recommended Inductor

Part Number	L	DCR	Size	Manufacturer
LQM2HPN4R7MGC	4.7µH; >2.45µH @ 0.5A	160mΩ	2.5x2.0x0.9mm max height 1.0mm	Murata www.murata.com
CIG32K1R0SAF	4.57µH; >2.45µH @ 0.5A	<300mΩ	2.0x1.25x0.9mm max height 1.0mm	Samsung Electro-Mechanics www.sem.samsung.co.kr

If a different inductor is chosen, ensure similar DCR values and at least 2.45µH inductance at maximum peak input current.

PCB Layout Guideline

The high speed operation requires proper layout for optimum performance. Route the power traces first and try to minimize the area and wire length of the three high frequency/high current loops:

Loop1: pin GND - C_{VIN} - L_{SW} - pin SW - pin GND

Loop2: pin GND - C_{VIN} - L_{SW} - pin SW - pin VOUT - C_{VOUT} - pin GND

At the pin GND a single via (or more vias, which are closely combined) connects to the common ground plane. This via(s) will isolate the DCDC high frequency currents from the common ground (as most high frequency current will flow between Loop1 and Loop2 and will not pass the ground plane) - see the 'island' at the two through ground vias in Figure 20:

Figure 20. Layout recommendation

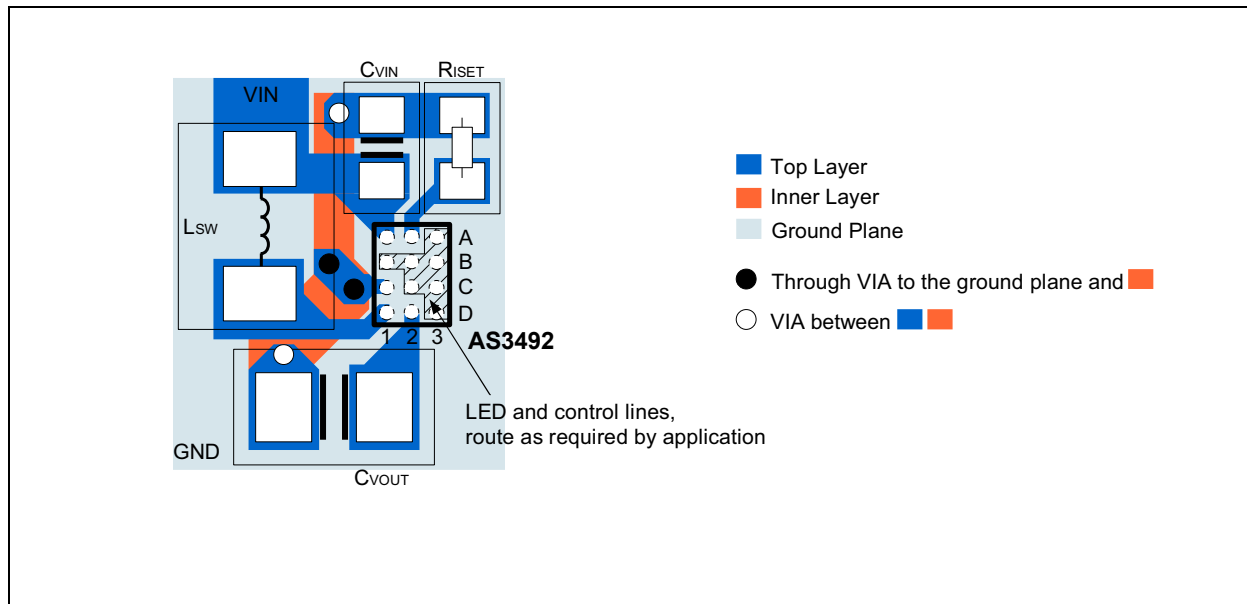

Note: If component placement rules allow, move all components close to the AS3492 to reduce the area and length of Loop1 and Loop2

10 Package Drawings and Markings

Figure 21. 12pin WL-CSP12 1.7x1.4x0.5mm Marking

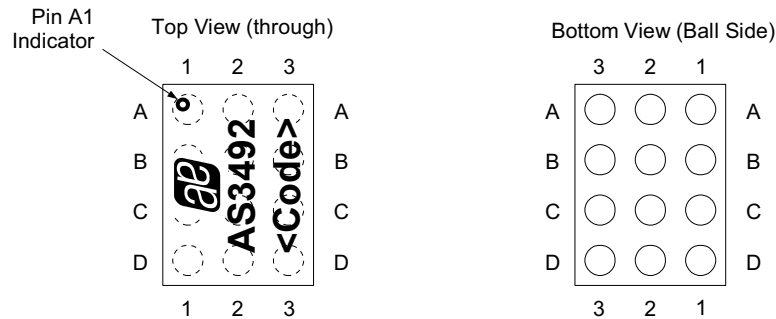

Note:

- Line 1: austriamicrosystems logo
- Line 2: AS3492
- Line 3: <Code>
Encoded Datecode (4 characters)

Figure 22. 12pin WL-CSP12 1.7x1.4x0.5mm Package Dimensions

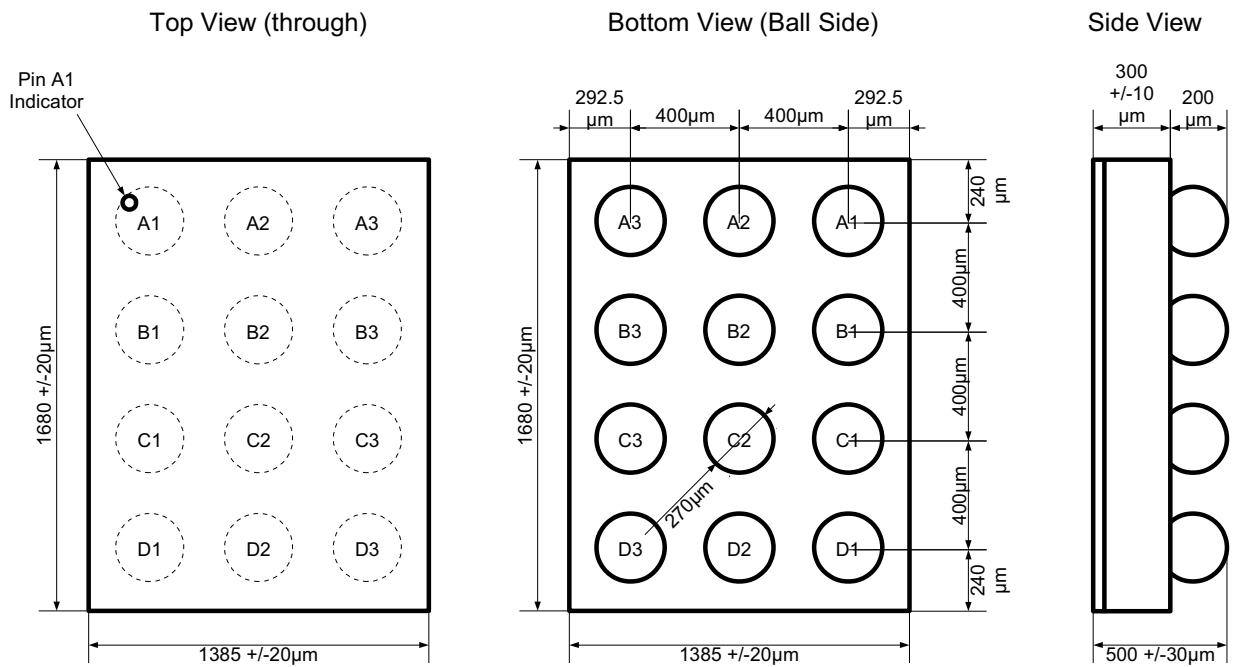

The coplanarity of the balls is 40µm.



11 Ordering Information

The devices are available as the standard products shown in [Table 7](#).

Table 7. Ordering Information

Model	Description	Delivery Form	Package
AS3492-ZWLT	Highly Efficient 2-10 LEDs Backlight Driver with 2 PWM Inputs	Tape & Reel	12-pin WL-CSP (1.7x1.4x0.5mm) RoHS compliant / Pb-Free / Green

Note: All products are RoHS compliant and austriamicrosystems green.

Buy our products or get free samples online at ICdirect: <http://www.austriamicrosystems.com/ICdirect>

Technical support is found at <http://www.austriamicrosystems.com/Technical-Support>

For further information and requests, please contact us <mailto:sales@austriamicrosystems.com>

or find your local distributor at <http://www.austriamicrosystems.com/distributor>

Note: AS3492-ZWLT

AS3492-

Z Temperature Range: -30°C - 85°C

WL Wafer Level Chip Scale Package (WL-CSP) 1.7x1.4x0.5mm

T Delivery Form: Tape & Reel

Copyrights

Copyright © 1997-2012, austriamicrosystems AG, Schloss Premstaetten, 8141 Unterpremstaetten, Austria-Europe. Trademarks Registered ®. All rights reserved. The material herein may not be reproduced, adapted, merged, translated, stored, or used without the prior written consent of the copyright owner.

All products and companies mentioned are trademarks or registered trademarks of their respective companies.

Disclaimer

Devices sold by austriamicrosystems AG are covered by the warranty and patent indemnification provisions appearing in its Term of Sale. austriamicrosystems AG makes no warranty, express, statutory, implied, or by description regarding the information set forth herein or regarding the freedom of the described devices from patent infringement. austriamicrosystems AG reserves the right to change specifications and prices at any time and without notice. Therefore, prior to designing this product into a system, it is necessary to check with austriamicrosystems AG for current information. This product is intended for use in normal commercial applications. Applications requiring extended temperature range, unusual environmental requirements, or high reliability applications, such as military, medical life-support or life-sustaining equipment are specifically not recommended without additional processing by austriamicrosystems AG for each application. For shipments of less than 100 parts the manufacturing flow might show deviations from the standard production flow, such as test flow or test location.

The information furnished here by austriamicrosystems AG is believed to be correct and accurate. However, austriamicrosystems AG shall not be liable to recipient or any third party for any damages, including but not limited to personal injury, property damage, loss of profits, loss of use, interruption of business or indirect, special, incidental or consequential damages, of any kind, in connection with or arising out of the furnishing, performance or use of the technical data herein. No obligation or liability to recipient or any third party shall arise or flow out of austriamicrosystems AG rendering of technical or other services.



Contact Information

Headquarters

austriamicrosystems AG

Tobelbaderstrasse 30

Schloss Premstaetten

A-8141 Austria

Tel: +43 (0) 3136 500 0

Fax: +43 (0) 3136 525 01

For Sales Offices, Distributors and Representatives, please visit:

<http://www.austriamicrosystems.com/contact>