

# Xinger®

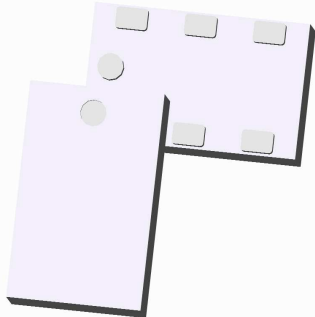

## Ultra Low Profile 0805 3 dB, 90° Hybrid Coupler

### Description

The C3337J5003AHF is a low cost, low profile sub-miniature high performance 3 dB coupler in an easy to use surface mount package. It is designed for LTE, WiMax and WiBro applications. The C3337J5003AHF is ideal for balanced power and low noise amplifiers, plus signal distribution and other applications where low insertion loss and tight amplitude and phase balance are required. The C3337J5003AHF is available on tape and reel for pick and place high volume manufacturing.

All of the Xinger components are constructed from ceramic filled PTFE composites which possess excellent electrical and mechanical stability. All parts have been subjected to rigorous qualification testing and units are 100% RF tested.

### Detailed Electrical Specifications: Specifications subject to change without notice.

Features:	Parameter	ROOM (25°C)			Unit	
		Min.	Typ.	Max		
<ul style="list-style-type: none"> <li>• 3300 – 3700 MHz</li> <li>• 0.7mm Height Profile</li> <li>• High Isolation &amp; Low Loss</li> <li>• LTE Bands: 22, 42, 43</li> <li>• WiMax and WiBro applications</li> <li>• Surface Mountable</li> <li>• Tape &amp; Reel</li> <li>• Non-conductive Surface</li> <li>• RoHS Compliant</li> <li>• Halogen-Free</li> <li>• 100% RF Tested</li> <li>• -55°C to 105°C</li> </ul>	Frequency	3300		3700	MHz	
	Port Impedance		50		Ω	
	Return Loss	15	18		dB	
	Isolation	18	22		dB	
	Insertion Loss		0.2	0.3	dB	
	Amplitude Balance		0.3	1.0	dB	
	Phase Balance (relative to 90°)		3	7	Degrees	
	Power Handling (+85 °C)			4	Watts	
	Power Handling (+105 °C)			3	Watts	
	Operating Temperature		-55		+105	°C
	<b>Group Delay (3.3-3.7GHZ) (nSec)</b>	<b>Min.</b>	<b>Typ.</b>		<b>Max</b>	
		0.050	0.055		0.060	

### Outline Drawing

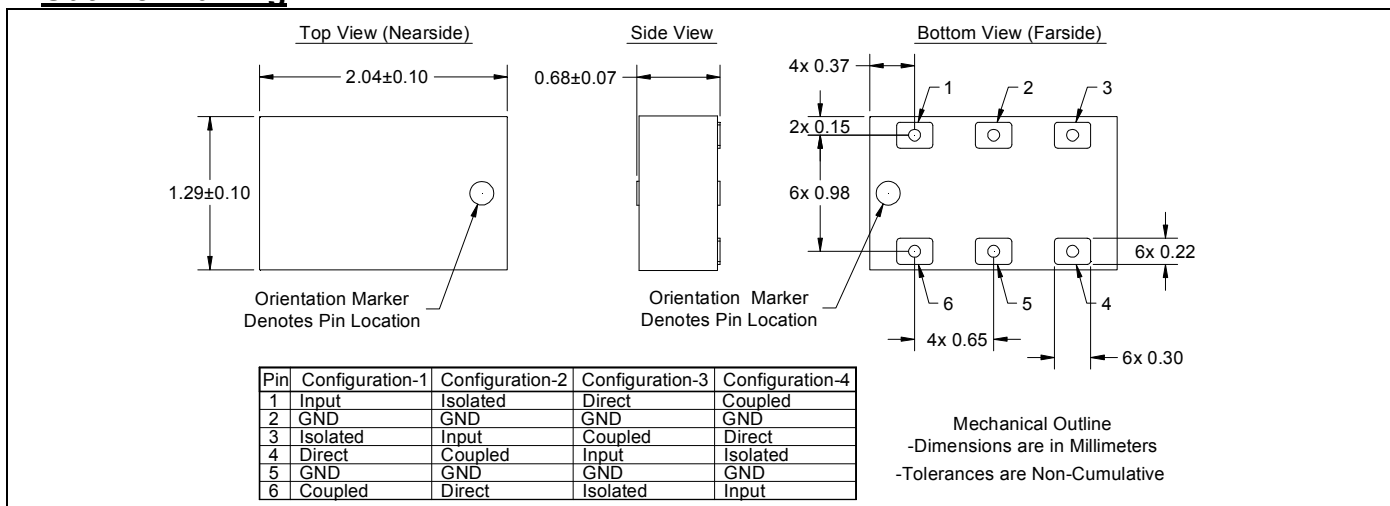

## Typical Broadband Performance: 500 MHz. to 6000 MHz.

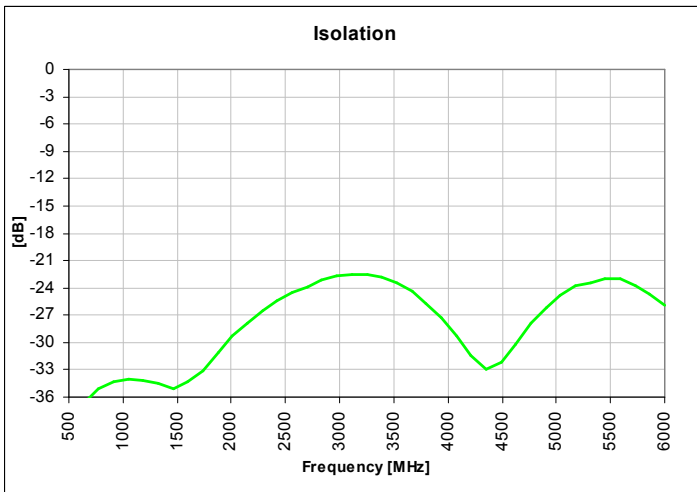
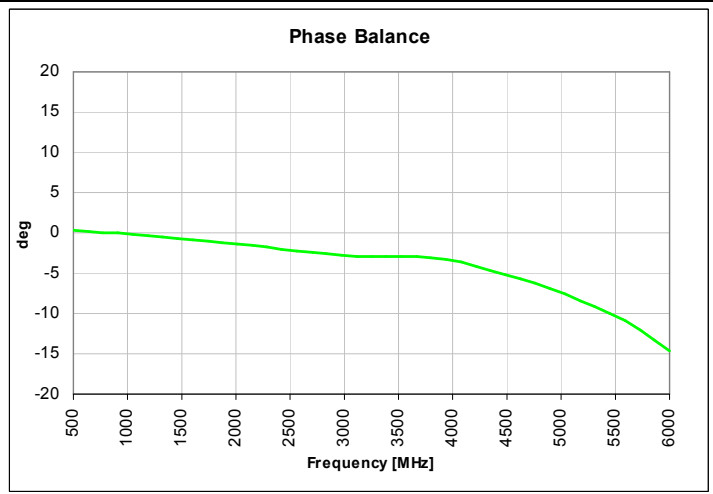
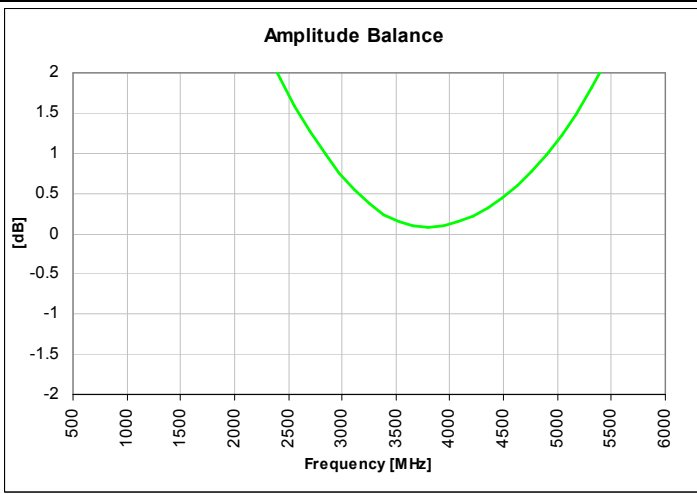
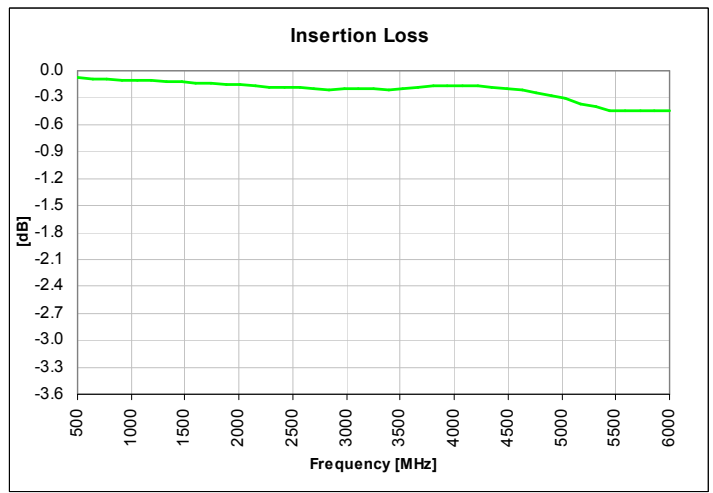
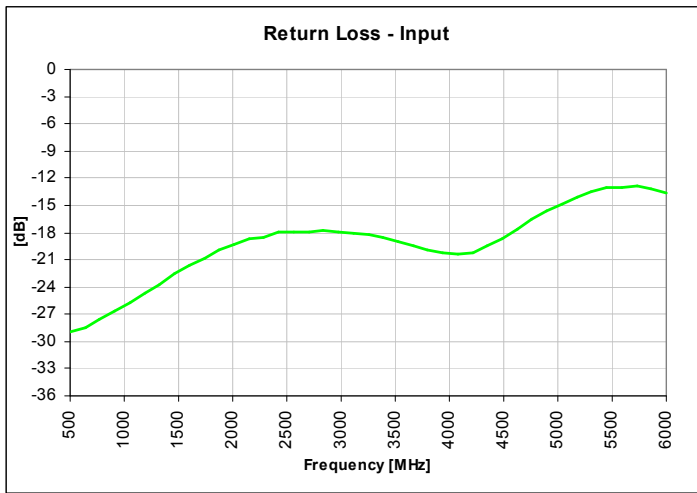

### Typical Performance: 3200 MHz. to 3800 MHz.

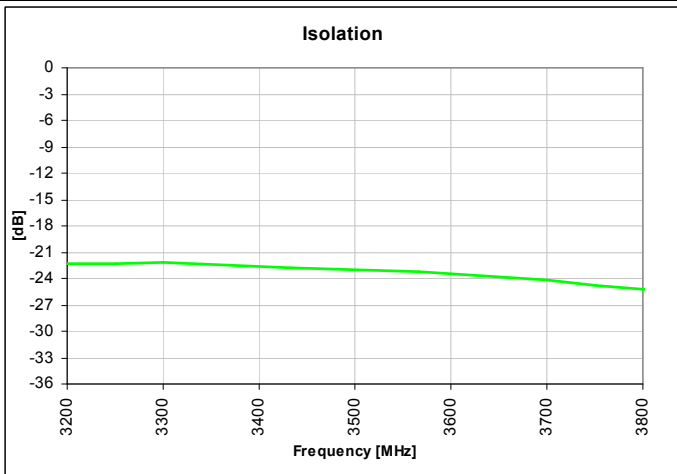
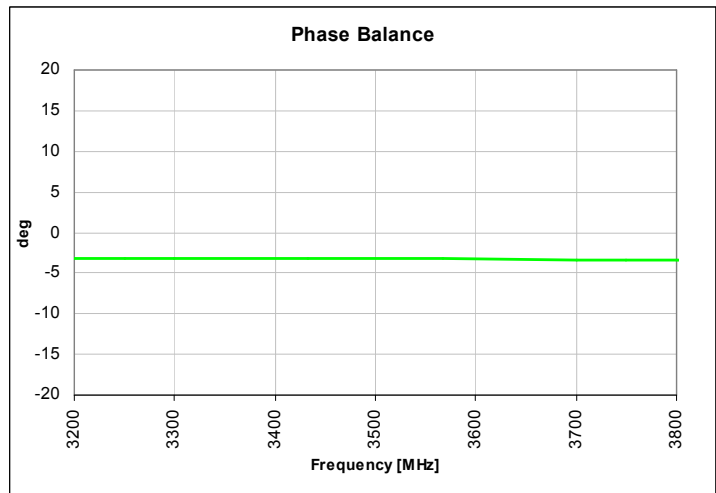
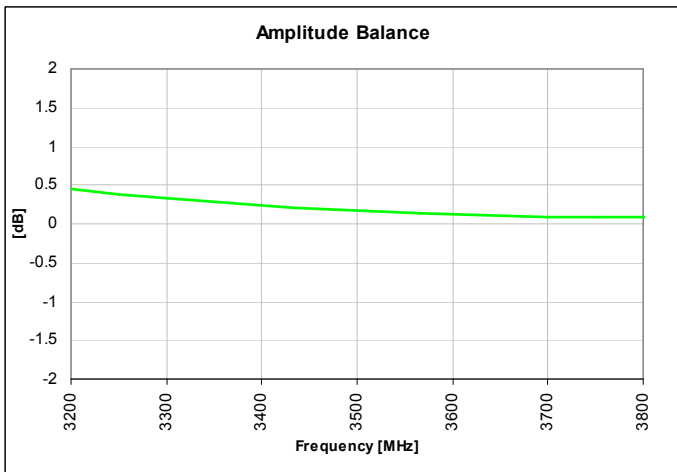
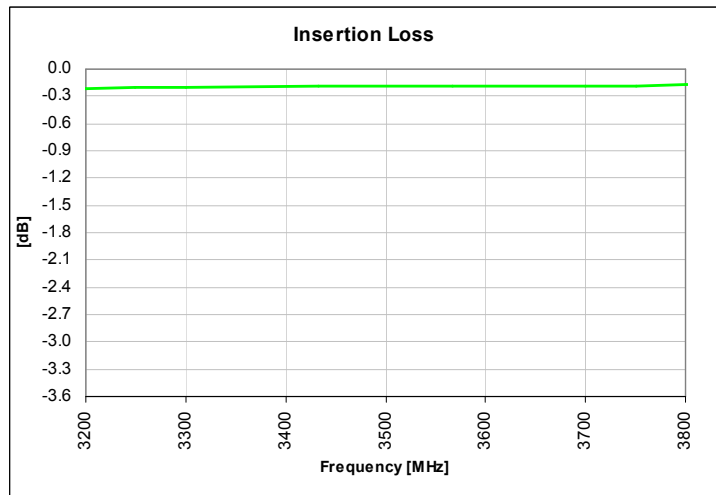
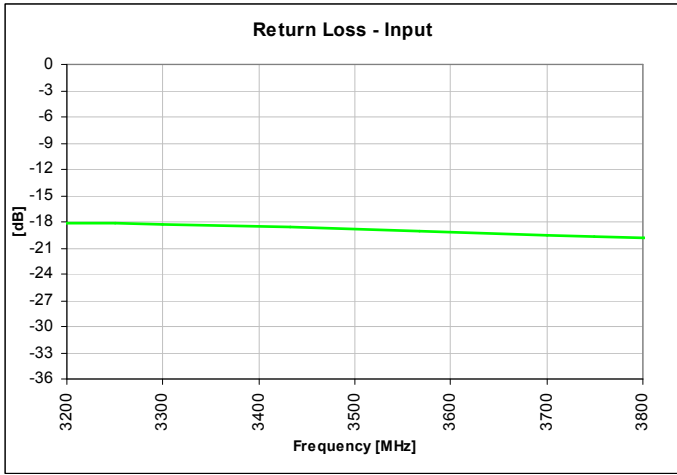

**Definition of Measured Specifications**

Parameter	Definition	Mathematical Representation <i>i, j, k, m</i> is denoted as the port index of input, isolated, direct and coupled port for specific pin configuration shown in the table
<b>Return Loss</b>	The impedance match of the coupler to a 50Ω system. Return Loss is an alternate means to express VSWR.	$20 \log_{10}( S_{ii} )$
<b>Isolation</b>	The input power divided by the sum of the power at the two output ports.	$20 \log_{10} S_{ji} $
<b>Insertion Loss</b>	The input power divided by the sum of the power at the two output ports.	$10 \log_{10}( S_{mi} ^2 +  S_{ki} ^2)$
<b>Amplitude Balance</b>	The difference in power between the two outputs.	$20 \log_{10}\left(\frac{ S_{ki} }{ S_{mi} }\right)$
<b>Phase Balance</b>	The difference in phase angle between the two output ports.	$\angle S_{ki} - \angle S_{mi} + 90^\circ$
<b>Group Delay</b>	Group delay is defined as the average of the mean group delay of the coupling path and the mean group delay of the direct path.	Group delay (ns) = $\frac{Mean(GD(S_{mi})) + Mean(GD(S_{ki}))}{2}$ where "Mean" is the arithmetic mean of the group delay over a frequency band.

\*100% RF test is performed per spec definition for pin configuration 1 and port 1 (input port) is connected to pin1, port 2 (isolated port) is connected to pin 3, port 3 (direct port) is connected to pin 4 and port 4 (isolated) is connected to pin 6.

### Mounting Configuration:

In order for Xinger surface mount components to work optimally, the proper impedance transmission lines must be used to connect to the RF ports. If this condition is not satisfied, insertion loss, Isolation and VSWR may not meet published specifications.

All of the Xinger components are constructed from organic PTFE based composites which possess excellent electrical and mechanical stability. Xinger components are compliant to a variety of ROHS and Green standards and ready for Pb-free soldering processes. Pads are Gold plated with a Nickel barrier.

An example of the PCB footprint used in the testing of these parts is shown below. In specific designs, the transmission line widths need to be adjusted to the unique dielectric coefficients and thicknesses as well as varying pick and place equipment tolerances.

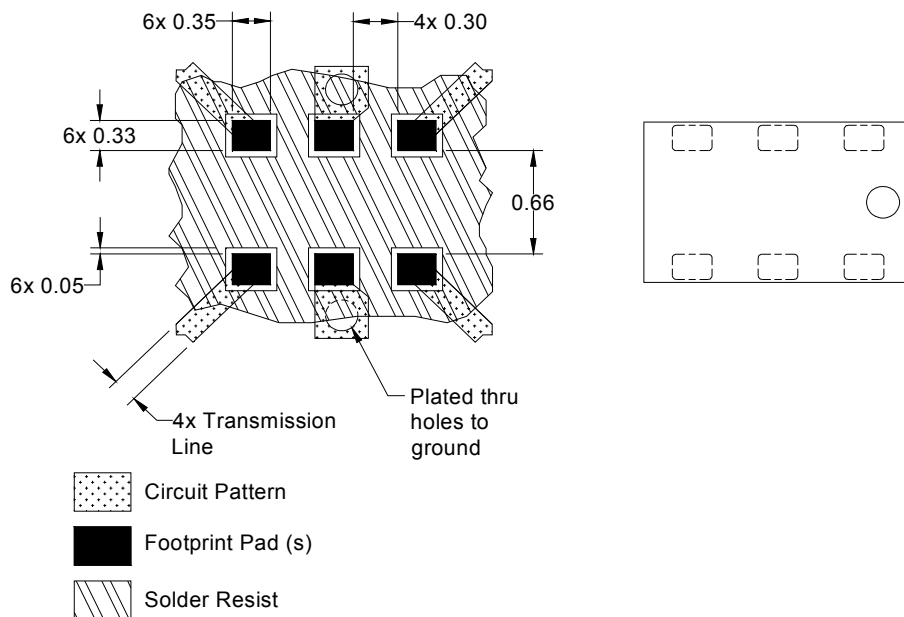

Dimensions are in Millimeters  
Mounting Footprint

## Packaging and Ordering Information

Parts are available in reel and are packaged per EIA 481-D. Parts are oriented in tape and reel as shown below. Minimum order quantities are 4000 per reel.

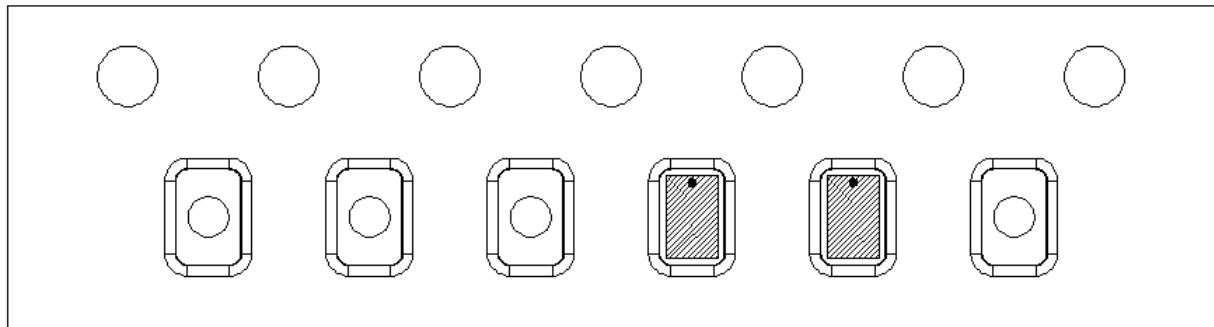

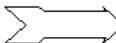
Direction of Part Feed (Unloading) 

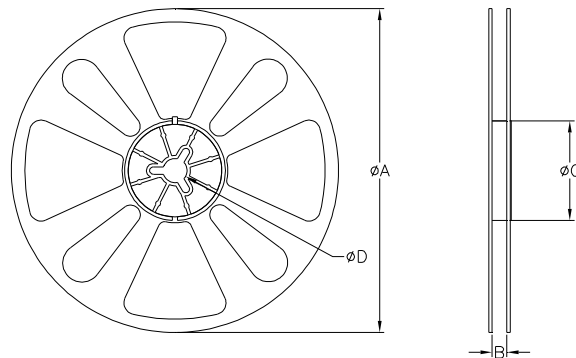

TABLE 1		
QUANTITY/REEL	REEL DIMENSIONS mm	
4000	$\phi A$	177.80
	B	8.00
	$\phi C$	50.80
	$\phi D$	13.00