

Xinger®

Ultra Low Profile 0805 Power Divider 75Ω to 75Ω

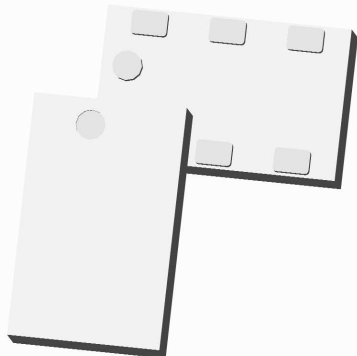

Description

The PD0922J7575D2HF is a low profile, sub-miniature Wilkinson power divider in an easy to use surface mount package and is ideal for high volume manufacturing while delivering higher performances than traditional printed and lumped element solutions. It has been designed for the following markets: DVB-S, GSM, DCS, PCS, WCDMA, GPS, 802.11a+g, Bluetooth, and Zigbee USA.

The PD0922J7575D2HF is matched to 75Ω and has a height profile of 0.8 mm. A two section Wilkinson design results in increased isolation performance. Two external resistors are required for operation. Components are available on tape and reel for high volume manufacturing pick and place.

Detailed Electrical Specifications: Specifications subject to change without notice.

| Features: | Parameter | ROOM (25°C) | | | Unit | |
|---|--------------------------|-------------|------|------|---------|----|
| | | Min. | Typ. | Max | | |
| <ul style="list-style-type: none"> • 950 – 2150 MHz • 16 dB Isolation (output ports) • Good Return Loss • 0.8mm Height Profile • 75Ω Outputs/Inputs • External resistors required • Low Insertion Loss • Surface Mountable • Tape & Reel • Non-conductive Surface • RoHS Compliant • Halogen Free | Frequency | 950 | | 2150 | MHz | |
| | Input Port Impedance | | 75 | | Ω | |
| | Output Port Impedance | | 75 | | Ω | |
| | Return Loss | 9.5 | 11 | | dB | |
| | Insertion Loss* | | 0.8 | 1.0 | dB | |
| | Amplitude Balance | | 0.4 | 0.7 | dB | |
| | Phase Balance | | 2 | 3 | Degrees | |
| | Isolation (Output Ports) | 14 | 16 | | dB | |
| | Power Handling | | | 2 | Watts | |
| | Operating Temperature | | -55 | | +85 | °C |

* Insertion Loss stated at room temperature (Insertion Loss is approximately 0.1 dB higher at +85 °C)

Outline Drawing

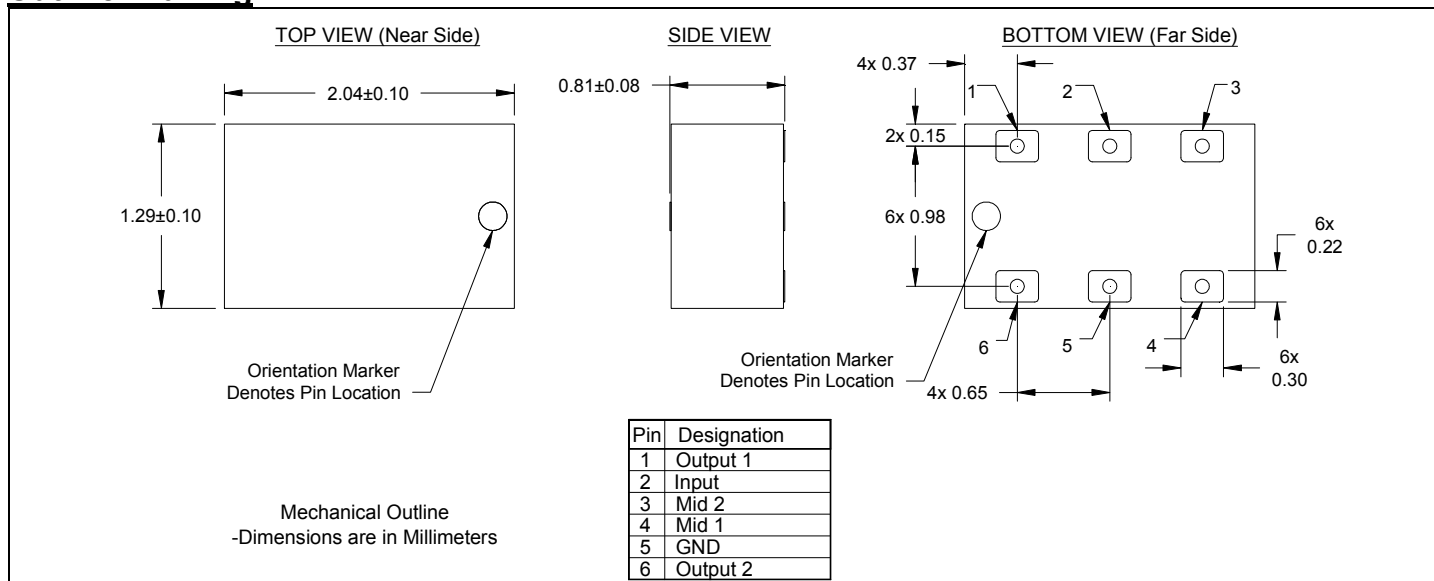

Typical Broadband Performance: 500 MHz. to 8.0 GHz.

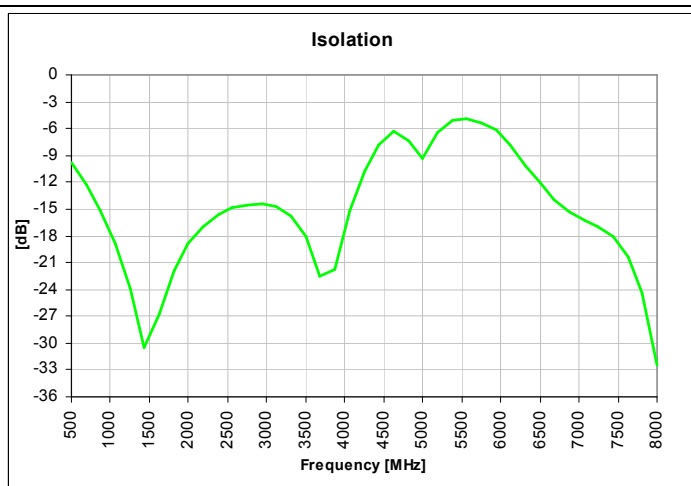
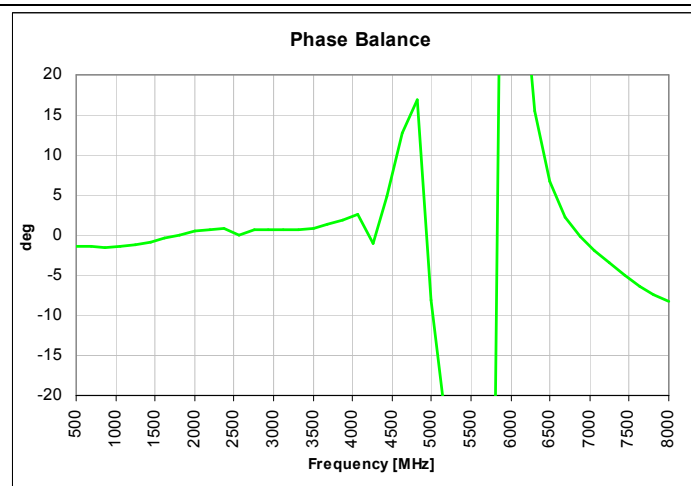
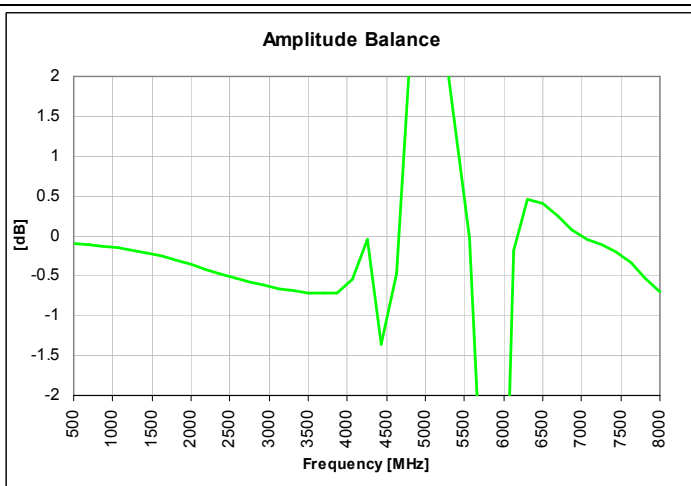
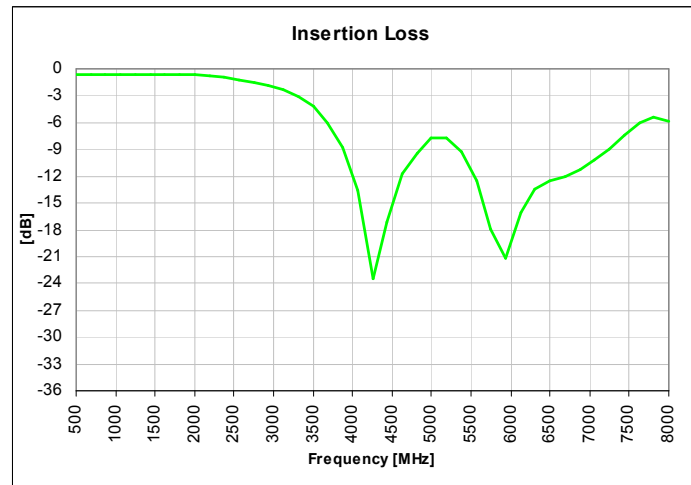
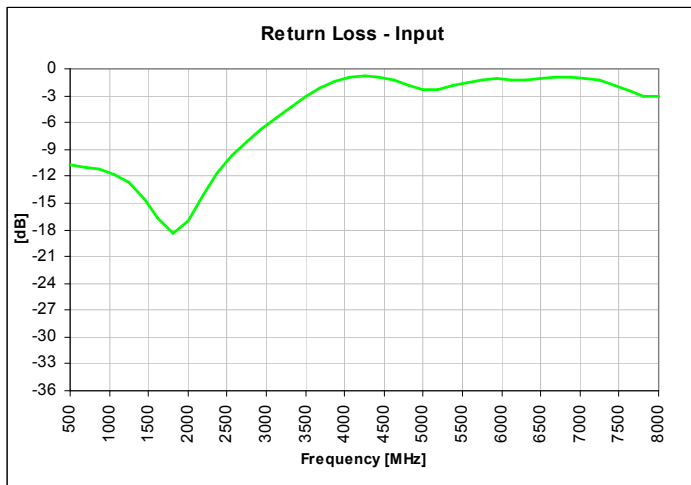

Typical Performance: 900 MHz. to 2200 MHz.

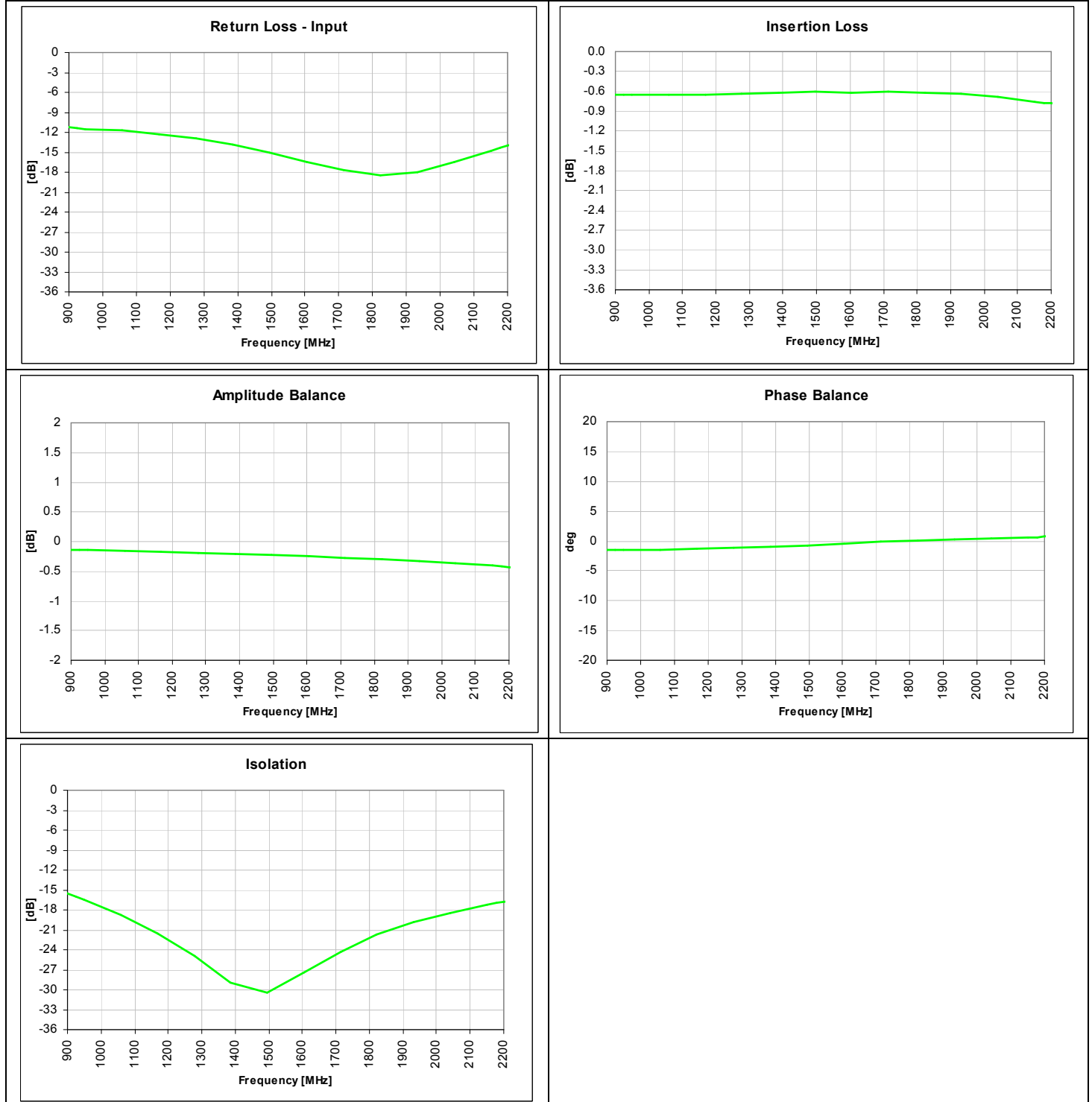

Mounting Configuration:

In order for Xinger surface mount components to work optimally, the proper impedance transmission lines must be used to connect to the RF ports. If this condition is not satisfied, insertion loss, Isolation and VSWR may not meet published specifications.

All of the Xinger components are constructed from organic PTFE based composites which possess excellent electrical and mechanical stability. Xinger components are compliant to a variety of ROHS and Green standards and ready for Pb-free soldering processes. Pads are Gold plated with a Nickel barrier.

An example of the PCB footprint used in the testing of these parts is shown below. In specific designs, the transmission line widths need to be adjusted to the unique dielectric coefficients and thicknesses as well as varying pick and place equipment tolerances. In addition, since the PD0922J7575D2HF is a Wilkinson power divider, external 0402 150Ω and 300Ω resistors must be mounted in locations R1 and R2 respectively, as shown in the Figure below.

Pad Footprint w/ 0402 Resistor Locations

 Circuit Pattern

 Footprint Pad (s)

 Solder Resist

Dimensions are in Millimeters
Mounting Footprint

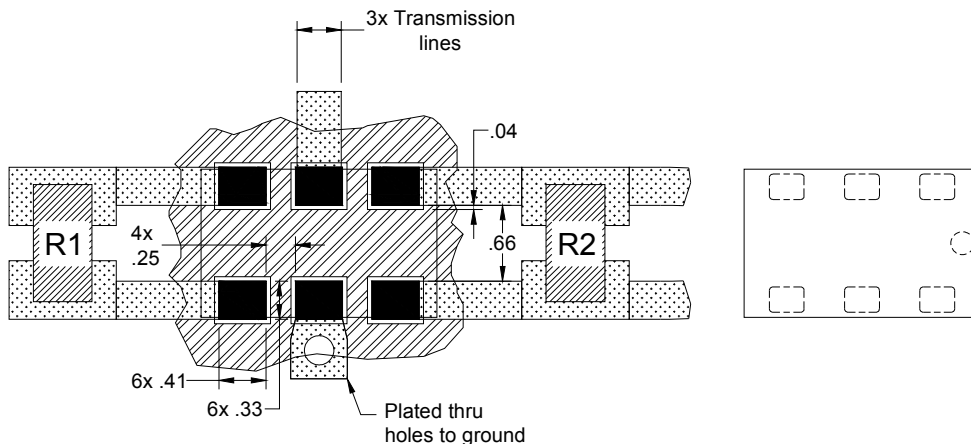

Packaging and Ordering Information

Parts are available in reel and are packaged per EIA 481-2. Parts are oriented in tape and reel as shown below. Minimum order quantities are 4000 per reel. See Model Numbers below for further ordering information.

