

- **Three-Channel RGB Color Sensor**
- **Converts Light Intensity to Voltage**
- **Single-Voltage Supply Operation — 4.5 V to 5.5 V**
- **Rail-to-Rail Output**
- **Programmable gain settings:**
 - TCS3103 (2×, 4×)
 - TCS3104 (4×, 1×)
- **Low Supply Current — 270 μ A Typical**
- **Fast Response Time — Rise Time = 12 μ s Typical**
- **Low Dark Offset**

PACKAGE FN
DUAL FLAT NO-LEAD
(TOP VIEW)

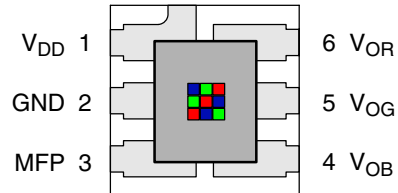

Description

The TCS3103 and TCS3104 RGB Light-to-Voltage Converters combine three photodiodes with optical filters, amplifiers, and gain-switching circuitry on a single chip. The output of each channel is a voltage that is linearly proportional to light intensity (irradiance) on the corresponding photodiode element. Gain is switchable via a digital input pin from 1× to 4× on the TCS3104, and from 2× to 4× on the TCS3103 (as compared to 1× of TCS3104).

Each channel on the device consists of a photodiode with a red, green, or blue optical filter, a current-to-voltage converter, and gain control elements. The voltage from each of the red, green, and blue channels is output on the V_{OR} , V_{OG} , and V_{OB} pins, respectively. The single MFP pin controls the gain for all three channels. Each of the three photodiode channels is split into three elements, which are dispersed in a 3×3 array. This makes the device less sensitive to non-uniform illumination across the sensing area. The overall photodiode active area is $378 \mu\text{m} \times 378 \mu\text{m}$. Each channel is factory-trimmed for low dark offset voltage and uniform sensitivity from device-to-device.

The TCS3103 and TCS3104 are intended for use in a variety of applications including color-point feedback control in solid-state illumination and backlight systems, color adjustment in printers, process controls, diagnostic systems, paper and product handling, toys, and games.

Functional Block Diagram

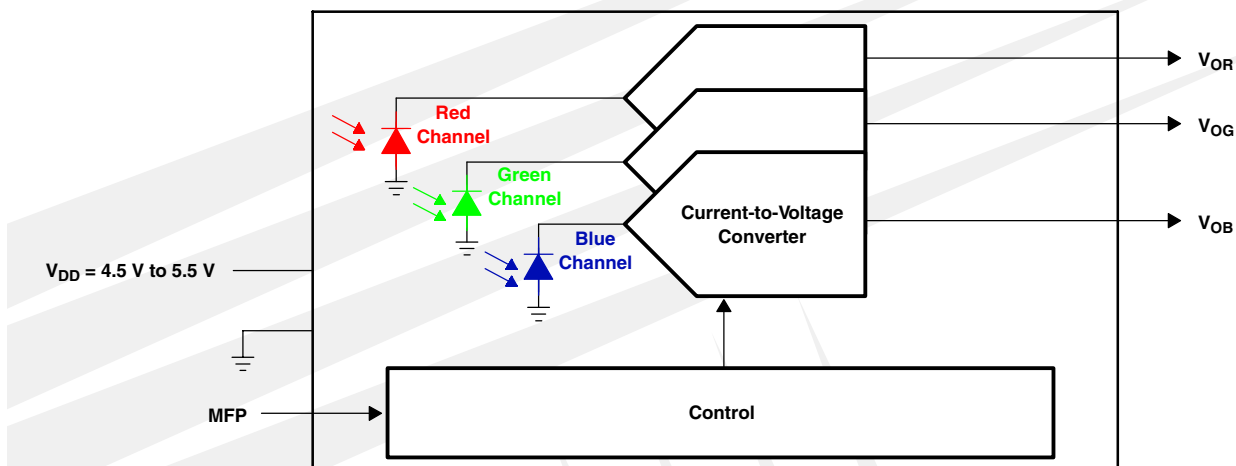

TCS3103, TCS3104 LIGHT-TO-VOLTAGE COLOR SENSOR

TAOS108B – JULY 2010

Detailed Description

The TCS3103 and TCS3104 devices output a voltage that is linearly proportional to light intensity in the spectral range of interest on each of the three sensor channels. Figure 2 shows how each sensor responds to light of various wavelengths. The peak response of each of the three channels roughly corresponds to blue, green, and red portions of the visible light spectrum. Thus, when light impinges upon the three elements, each element gives an output that corresponds to the blue, green, and red components of the light. By measuring the amplitude and ratios of the three channels, information about the color of the light can be obtained.

Each channel responds linearly to light intensity from a range of near zero light to a maximum value that is determined by the gain and the supply voltage of the device. The output of the device can swing from near ground level to near the supply voltage of the device. The dark voltage, or output of the device with no light input, is determined by internal amplifier offsets and is factory-trimmed to be a minimum value. If very accurate, low-level light measurement is required, the dark voltage value for each channel can be measured and subtracted from subsequent light readings to obtain a more accurate light measurement.

The Multifunction Pin (MFP) on each device can be used for selecting gain mode (Table 1).

Table 1. Device Programming Option

Device	Mode	Details
TCS3103	GSM (Gain Select Mode)	2× (MFP = 0) or 4× (MFP = 1)
TCS3104	GSM (Gain Select Mode)	4× (MFP = 0) or 1× (MFP = 1)

Terminal Functions

TERMINAL NAME	NO.	TYPE	DESCRIPTION
GND	2	Power	Power supply ground. All voltages are referenced to GND.
MFP	3	I	Multi-function logic input.
V _{DD}	1	Power	Supply voltage.
V _{OB}	4	O	Blue channel voltage output.
V _{OG}	5	O	Green channel voltage output.
V _{OR}	6	O	Red channel voltage output.

Available Options

DEVICE	Gain	PACKAGE – LEADS	PACKAGE DESIGNATOR	ORDERING NUMBER
TCS3103	2×, 4×	Dual Flat No-Lead – 6	FN	TCS3103FN
TCS3104	4×, 1×	Dual Flat No-Lead – 6	FN	TCS3104FN

Absolute Maximum Ratings over operating free-air temperature range (unless otherwise noted)†

Supply voltage, V_{DD} (see Note 1)	6 V
Storage temperature range, T_{stg}	–40°C to 85°C
ESD tolerance, human body model	2000 V
Moisture sensitivity level	3
Solder conditions in accordance with JEDEC J–STD–020A, maximum temperature	260°C

† Stresses beyond those listed under “absolute maximum ratings” may cause permanent damage to the device. These are stress ratings only, and functional operation of the device at these or any other conditions beyond those indicated under “recommended operating conditions” is not implied. Exposure to absolute-maximum-rated conditions for extended periods may affect device reliability.

NOTE 1: All voltages are with respect to GND.

Recommended Operating Conditions

		MIN	NOM	MAX	UNIT
Supply voltage, V_{DD}		4.5	5	5.5	V
Operating free-air temperature, T_A		–30		70	°C
Input low voltage on MFP pin, V_{IL}	$V_{DD} = 5\text{ V}$	–0.5		1.5	V
Input high voltage on MFP pin, V_{IH}	$V_{DD} = 5\text{ V}$	3.5		5.5	V
Load capacitance, C_L	$V_{DD} = 5\text{ V}$			100	pF

Electrical Characteristics $V_{DD} = 5\text{ V}$, $T_A = 25^\circ\text{C}$, $R_L = 10\text{ k}\Omega$ (unless otherwise noted)

PARAMETER	TEST CONDITIONS	MIN	TYP	MAX	UNIT
V_D Dark voltage, V_{OR} , V_{OG} , V_{OB}	$E_e = 0$	0		10	mV
V_{OM} Maximum output voltage	$V_{DD} = 5\text{ V}$	4.8			V
I_{DD} Supply current	$V_{DD} = 5\text{ V}$, $E_e = 0$		270	500	μA
R_{eR} Irradiance responsivity, V_{OR}	$\lambda_p = 470\text{ nm}$, Gain select = 1X		0.02		mV/ ($\mu\text{W}/\text{cm}^2$)
	$\lambda_p = 524\text{ nm}$, Gain select = 1X		0.09		
	$\lambda_p = 640\text{ nm}$, Gain select = 1X	0.3	0.4	0.5	
R_{eG} Irradiance responsivity, V_{OG}	$\lambda_p = 470\text{ nm}$, Gain select = 1X		0.13		mV/ ($\mu\text{W}/\text{cm}^2$)
	$\lambda_p = 524\text{ nm}$, Gain select = 1X	0.18	0.25	0.31	
	$\lambda_p = 640\text{ nm}$, Gain select = 1X		0.06		
R_{eB} Irradiance responsivity, V_{OB}	$\lambda_p = 470\text{ nm}$, Gain select = 1X	0.15	0.2	0.25	mV/ ($\mu\text{W}/\text{cm}^2$)
	$\lambda_p = 524\text{ nm}$, Gain select = 1X		0.13		
	$\lambda_p = 640\text{ nm}$, Gain select = 1X		0.12		
Gain scaling, 1X to 2X		1.9	2	2.1	
Gain scaling, 1X to 4X		3.8	4	4.2	
T_C Temperature coefficient of output voltage	$\lambda_p \leq 700\text{ nm}$, $-30^\circ\text{C} \leq T_A \leq 70^\circ\text{C}$		± 360		ppm/°C

Dynamic Characteristics, $V_{DD} = 5\text{ V}$, $T_A = 25^\circ\text{C}$, $R_L = 10\text{ k}\Omega$ (unless otherwise noted)

PARAMETER	TEST CONDITIONS	MIN	TYP	MAX	UNIT
t_r Output pulse rise time, 10% to 90% of final value	Gain select = 1X		12		μs
	Gain select = 2X		24		μs
	Gain select = 4X		40		μs
t_f Output pulse fall time, 90% to 10% of final value	Gain select = 1X		15		μs
	Gain select = 2X		28		μs
	Gain select = 4X		44		μs
Integrated noise voltage	$f = \text{DC to } 1\text{ kHz}$, $E_e = 0$		200		μVrms
t_{pZX} Propagation delay, output active	V_{DD} ramp 0 V to 5 V			50	ms

TCS3103, TCS3104 LIGHT-TO-VOLTAGE COLOR SENSOR

TAOS108B – JULY 2010

PARAMETER MEASUREMENT INFORMATION

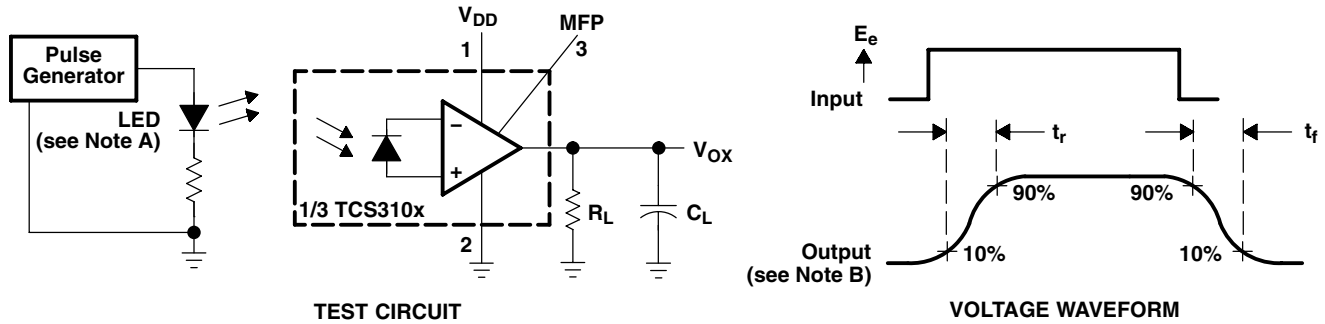

- NOTES: A. The input irradiance is supplied by a pulsed AlInGaP light-emitting diode with the following characteristics: $\lambda_p = 640 \text{ nm}$, $t_r < 1 \mu\text{s}$, $t_f < 1 \mu\text{s}$.
- B. The output waveform is monitored on an oscilloscope with the following characteristics: $t_r < 100 \text{ ns}$, $Z_i \geq 1 \text{ M}\Omega$, $C_i \leq 20 \text{ pF}$.

Figure 1. Switching Times

TYPICAL CHARACTERISTICS

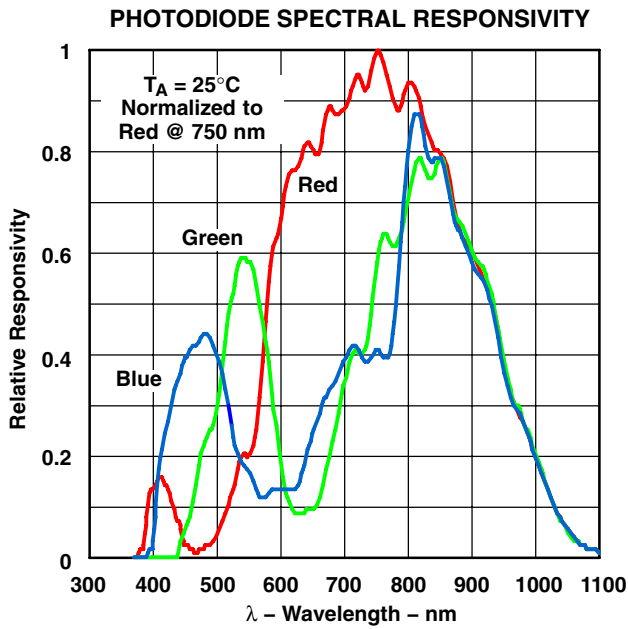

Figure 2

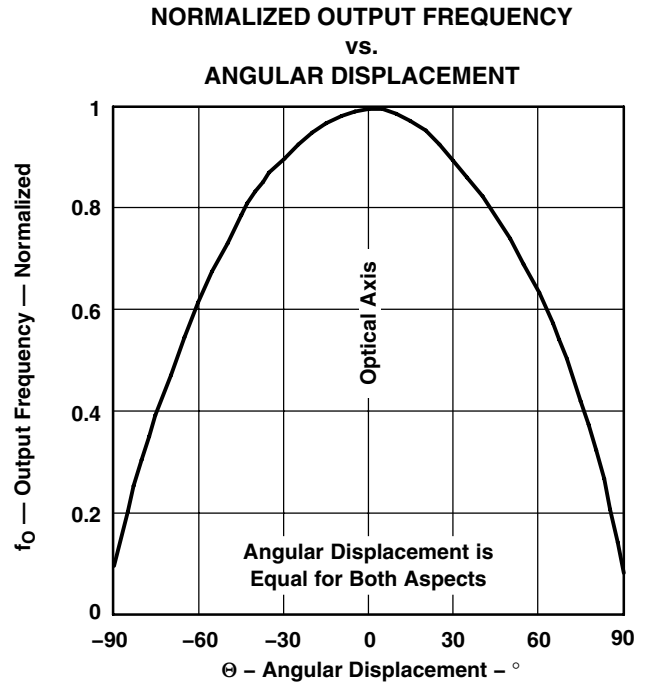

Figure 3

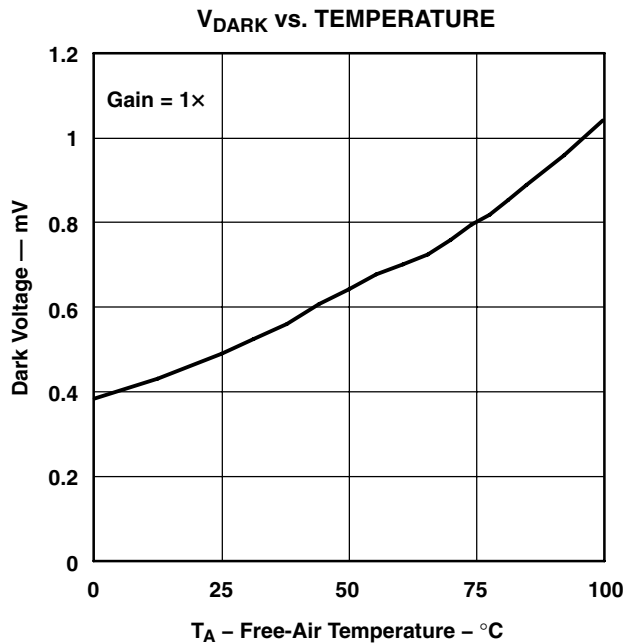

Figure 4

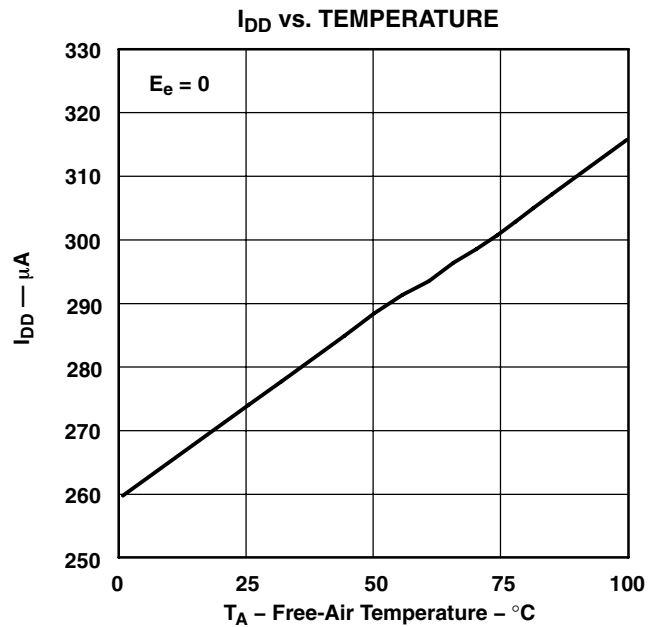

Figure 5

TCS3103, TCS3104 LIGHT-TO-VOLTAGE COLOR SENSOR

TAOS108B – JULY 2010

APPLICATION INFORMATION

Power Supply Considerations

The power supply lines (V_{DD} and GND) should be bypassed by placing an 0.1- μ F capacitor with low ESR and short leads (ideally, a surface mount ceramic type) as close as possible to the device package.

Output Interface

Although the output of the device can be connected to a comparator for simple threshold measurements, or to another amplifier stage, most applications will require that the three channels be connected to analog-to-digital converters (ADCs) so that the light and color information can be processed by a microcontroller, computer, or other device. In many cases, the outputs can be directly connected to the ADC inputs. In some cases, for example if the light is modulated, it may be desirable to insert active or passive low-pass filters on the channels prior to the ADC, to smooth out the modulation ripple that would otherwise result in noisy measurements. The cutoff frequency of the filters would, of course, depend upon the modulation frequency of the incoming light. With a pulse-width modulated (PWM) input light signal, it may be possible to synchronize the ADC sampling with the on-time of the PWM signal. In this case, a low-pass filter would not be required because the device output would be sampled only during the on time of the input light source. A recommendation for minimum pulse width would be $3 \times$ the rise time of the device under the chosen gain setting.

Device Power Up

The TCS310x should use the following power up sequence: A stable ground reference from the system should be applied first, followed by the V_{DD} power applied second. This means V_{DD} cannot be applied while the GND pin is floating or without a ground reference. Afterward, the MFP pin may be biased or driven. The MFP pin must always have a valid logic reference level. The pin may be biased or driven to a logical high or logical low level.

PCB Pad Layout

Suggested PCB pad layout guidelines for the Dual Flat No-Lead (FN) surface mount package are shown in Figure 6.

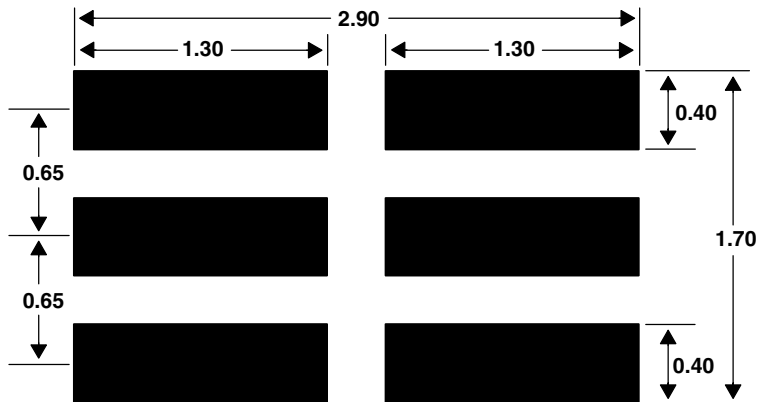

- NOTES: A. All linear dimensions are in millimeters.
B. This drawing is subject to change without notice.

Figure 6. Suggested FN Package PCB Layout

MECHANICAL DATA

PACKAGE FN
TOP VIEW

Dual Flat No-Lead

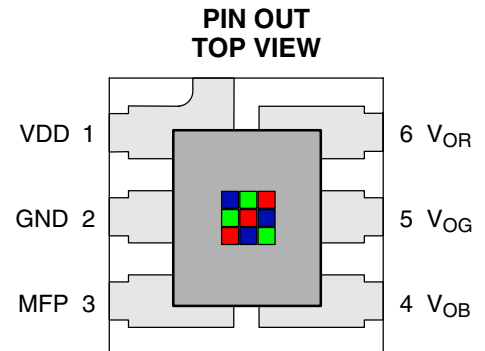
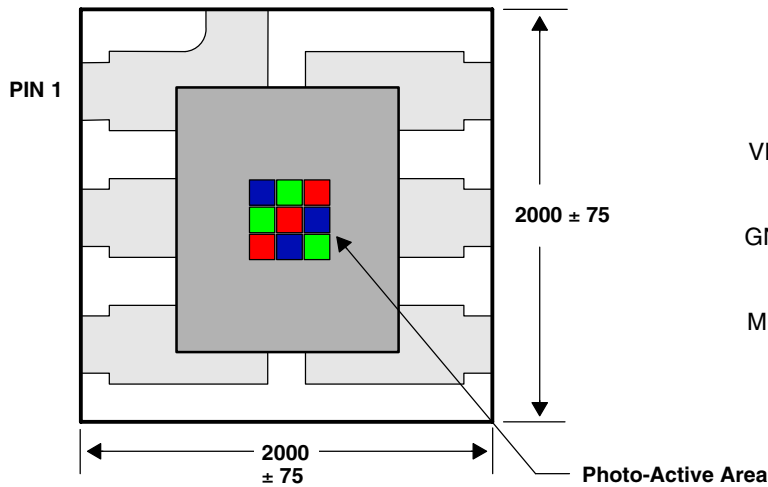

END VIEW

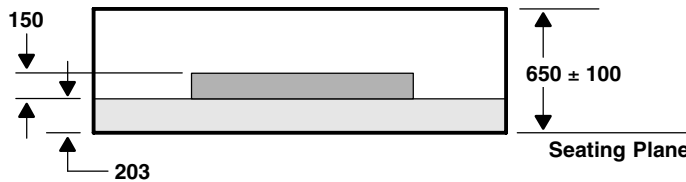

SIDE VIEW

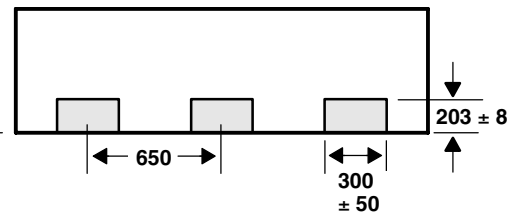

BOTTOM VIEW

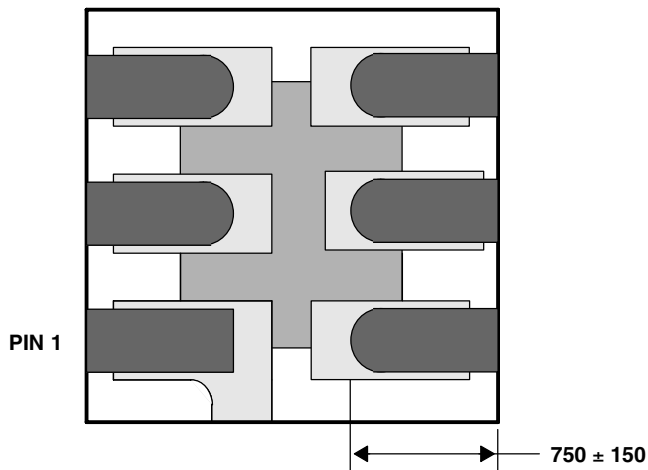

Lead Free

- NOTES: A. All linear dimensions are in micrometers. Dimension tolerance is $\pm 20 \mu\text{m}$ unless otherwise noted.
 B. The photo-active area is $378 \mu\text{m}$ by $378 \mu\text{m}$, centered vertically and horizontally with a $\pm 75 \mu\text{m}$ tolerance.
 C. Package top surface is molded with an electrically nonconductive clear plastic compound having an index of refraction of 1.55.
 D. Contact finish is copper alloy A194 with pre-plated NiPdAu lead finish.
 E. This package contains no lead (Pb).
 F. This drawing is subject to change without notice.

Figure 7. Package FN — Dual Flat No-Lead Packaging Configuration

TCS3103, TCS3104 LIGHT-TO-VOLTAGE COLOR SENSOR

TAOS108B – JULY 2010

MECHANICAL DATA

TOP VIEW

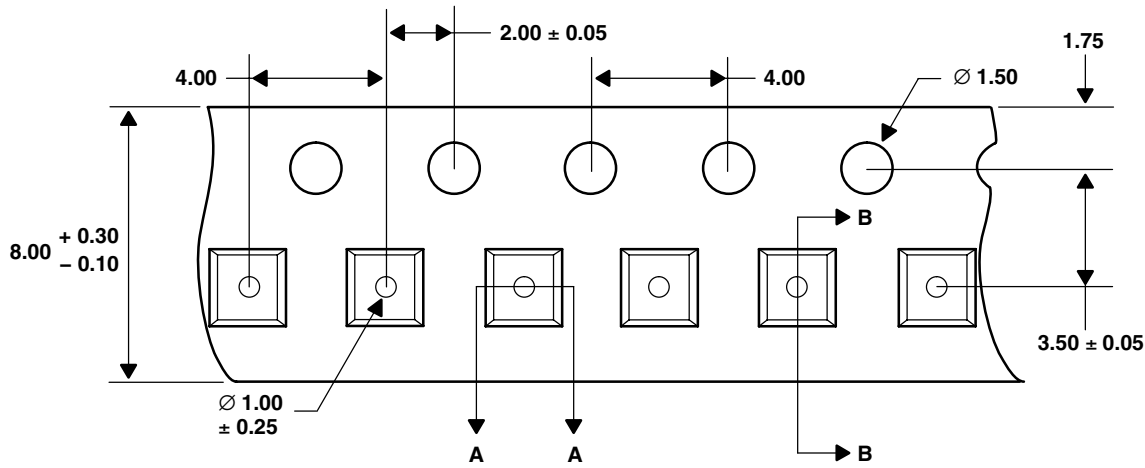

DETAIL A

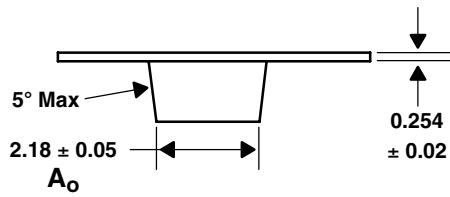

DETAIL B

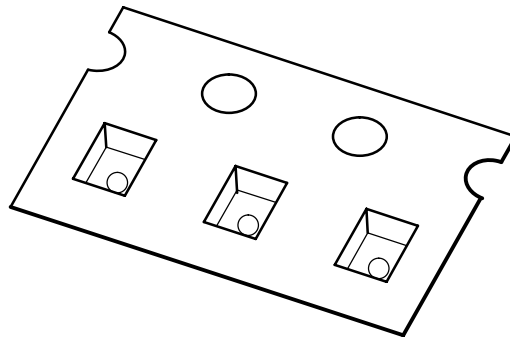
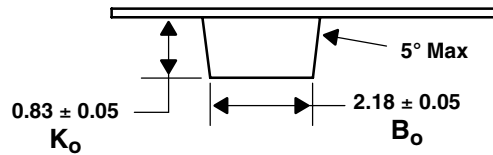

- NOTES: A. All linear dimensions are in millimeters. Dimension tolerance is ± 0.10 mm unless otherwise noted.
 B. The dimensions on this drawing are for illustrative purposes only. Dimensions of an actual carrier may vary slightly.
 C. Symbols on drawing A_o , B_o , and K_o are defined in ANSI EIA Standard 481-B 2001.
 D. Each reel is 178 millimeters in diameter and contains 3500 parts.
 E. TAOS packaging tape and reel conform to the requirements of EIA Standard 481-B.
 F. In accordance with EIA standard, device pin 1 is located next to the sprocket holes in the tape.
 G. This drawing is subject to change without notice.

Figure 8. Package FN Carrier Tape

MANUFACTURING INFORMATION

The FN package has been tested and has demonstrated an ability to be reflow soldered to a PCB substrate. The process, equipment, and materials used in these test are detailed below.

The solder reflow profile describes the expected maximum heat exposure of components during the solder reflow process of product on a PCB. Temperature is measured on top of component. The components should be limited to a maximum of three passes through this solder reflow profile.

Table 2. TCS310x Solder Reflow Profile

PARAMETER	REFERENCE	TCS310x
Average temperature gradient in preheating		2.5°C/sec
Soak time	t_{soak}	2 to 3 minutes
Time above 217°C	t_1	Max 60 sec
Time above 230°C	t_2	Max 50 sec
Time above $T_{peak} - 10^\circ\text{C}$	t_3	Max 10 sec
Peak temperature in reflow	T_{peak}	260°C
Temperature gradient in cooling		Max $-5^\circ\text{C}/\text{sec}$

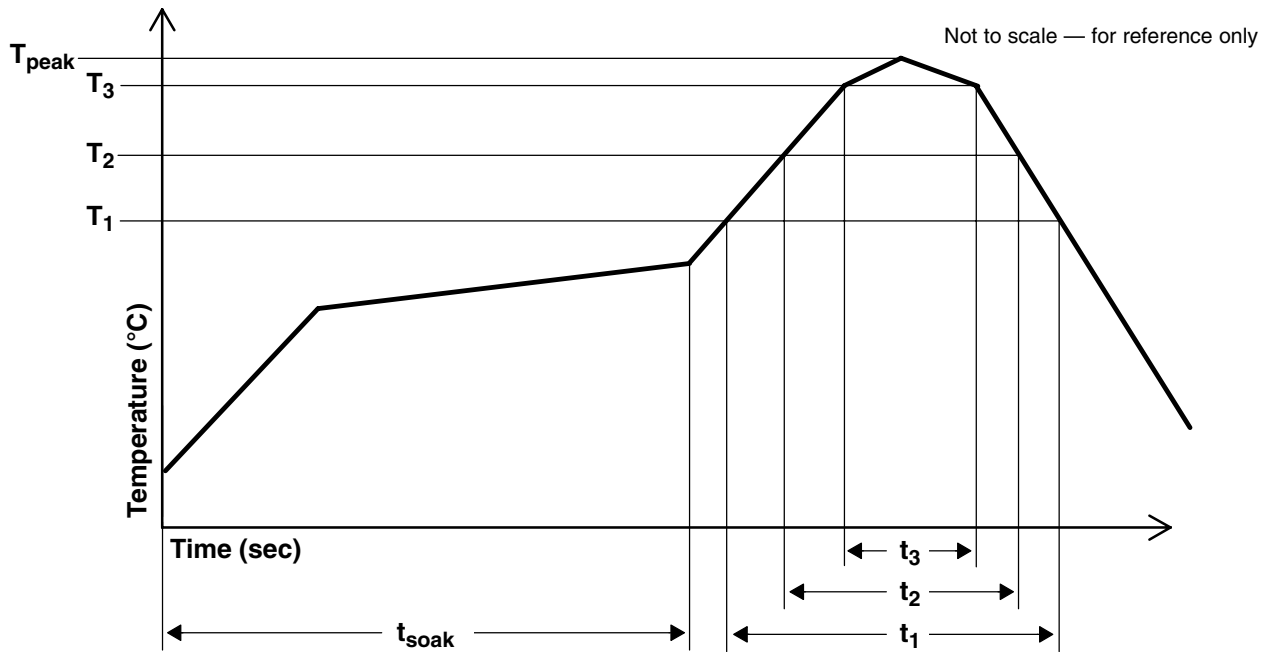

Figure 9. TCS310x Solder Reflow Profile Graph

TCS3103, TCS3104 LIGHT-TO-VOLTAGE COLOR SENSOR

TAOS108B – JULY 2010

MANUFACTURING INFORMATION

Moisture Sensitivity

Optical characteristics of the device can be adversely affected during the soldering process by the release and vaporization of moisture that has been previously absorbed into the package molding compound. To ensure the package molding compound contains the smallest amount of absorbed moisture possible, each device is dry-baked prior to being packed for shipping. Devices are packed in a sealed aluminized envelope with silica gel to protect them from ambient moisture during shipping, handling, and storage before use.

The FN package has been assigned a moisture sensitivity level of MSL 3 and the devices should be stored under the following conditions:

Temperature Range	5°C to 50°C
Relative Humidity	60% maximum
Total Time	6 months from the date code on the aluminized envelope — if unopened
Opened Time	168 hours or fewer

Rebaking will be required if the devices have been stored unopened for more than 6 months or if the aluminized envelope has been open for more than 168 hours. If rebaking is required, it should be done at 50°C for 12 hours.

PRODUCTION DATA — information in this document is current at publication date. Products conform to specifications in accordance with the terms of Texas Advanced Optoelectronic Solutions, Inc. standard warranty. Production processing does not necessarily include testing of all parameters.

LEAD-FREE (Pb-FREE) and GREEN STATEMENT

Pb-Free (RoHS) TAOS' terms *Lead-Free* or *Pb-Free* mean semiconductor products that are compatible with the current RoHS requirements for all 6 substances, including the requirement that lead not exceed 0.1% by weight in homogeneous materials. Where designed to be soldered at high temperatures, TAOS Pb-Free products are suitable for use in specified lead-free processes.

Green (RoHS & no Sb/Br) TAOS defines *Green* to mean Pb-Free (RoHS compatible), and free of Bromine (Br) and Antimony (Sb) based flame retardants (Br or Sb do not exceed 0.1% by weight in homogeneous material).

Important Information and Disclaimer The information provided in this statement represents TAOS' knowledge and belief as of the date that it is provided. TAOS bases its knowledge and belief on information provided by third parties, and makes no representation or warranty as to the accuracy of such information. Efforts are underway to better integrate information from third parties. TAOS has taken and continues to take reasonable steps to provide representative and accurate information but may not have conducted destructive testing or chemical analysis on incoming materials and chemicals. TAOS and TAOS suppliers consider certain information to be proprietary, and thus CAS numbers and other limited information may not be available for release.

NOTICE

Texas Advanced Optoelectronic Solutions, Inc. (TAOS) reserves the right to make changes to the products contained in this document to improve performance or for any other purpose, or to discontinue them without notice. Customers are advised to contact TAOS to obtain the latest product information before placing orders or designing TAOS products into systems.

TAOS assumes no responsibility for the use of any products or circuits described in this document or customer product design, conveys no license, either expressed or implied, under any patent or other right, and makes no representation that the circuits are free of patent infringement. TAOS further makes no claim as to the suitability of its products for any particular purpose, nor does TAOS assume any liability arising out of the use of any product or circuit, and specifically disclaims any and all liability, including without limitation consequential or incidental damages.

TEXAS ADVANCED OPTOELECTRONIC SOLUTIONS, INC. PRODUCTS ARE NOT DESIGNED OR INTENDED FOR USE IN CRITICAL APPLICATIONS IN WHICH THE FAILURE OR MALFUNCTION OF THE TAOS PRODUCT MAY RESULT IN PERSONAL INJURY OR DEATH. USE OF TAOS PRODUCTS IN LIFE SUPPORT SYSTEMS IS EXPRESSLY UNAUTHORIZED AND ANY SUCH USE BY A CUSTOMER IS COMPLETELY AT THE CUSTOMER'S RISK.

LUMENOLOGY, TAOS, the TAOS logo, and Texas Advanced Optoelectronic Solutions are registered trademarks of Texas Advanced Optoelectronic Solutions Incorporated.

TCS3103, TCS3104 LIGHT-TO-VOLTAGE COLOR SENSOR

TAOS108B – JULY 2010
