

AS1325

300mA Step-Up DC-DC Converter

Data Sheet

1 General Description

The AS1325 is a high-efficiency step-up DC-DC converter designed to generate a fixed output voltage of +3.3V or +5V.

The AS1325 achieves an efficiency of up to 96% and the minimum input voltage is 1.5V. The AS1325-BSTT-33 delivers up to 300mA output current at the fixed output voltage of +3.3V (@ 2V V_{BATT}). With the fixed output voltage of +5V the AS1325-BSST-50 supplies up to 185mA output current (@ 2V V_{BATT}).

In order to save power the AS1325 features a shutdown mode, where it draws less than 1 μ A. In shutdown mode the battery is connected directly to the output enabling the supply of real-time-clocks.

The AS1325 provides a power-on reset output that goes high-impedance when the output reaches 90% of its regulation point.

The SHDNN trip threshold of the AS1325 can be used as an input voltage detector that disables the device when the battery voltage falls to a predetermined level.

An internal synchronous rectifier is included.

The AS1325 is available in a 6-pin SOT23 package.

2 Key Features

- Fixed Output Voltage:
 - 3.3V (AS1325-BSTT-33) or 5V (AS1325-BSST-50)
- Output Current:
 - Up to 300mA (AS1325-BSTT-33) @ 2V V_{BATT}
 - Up to 185mA (AS1325-BSST-50) @ 2V V_{BATT}
- Internal Synchronous Rectifier
- Shutdown Mode Supply Current: Less Than 1 μ A
- Efficiency: Up to 96%
- Minimum Input Voltage: +1.5V
- Accurate Shutdown Low-Battery Cutoff Threshold
- Battery Input Connected to Pin OUT in Shutdown Mode for Backup Power
- Antiringing Control Minimizes EMI
- Ripple Reduction at Light Loads
- 6-pin SOT23 Package

3 Applications

The AS1325 is ideal for low-power applications where ultra-small size is critical as in medical diagnostic equipment, hand-held instruments, pagers, digital cameras, remote wireless transmitters, cordless phones, and PC cards. The device is also perfect as a local supply or as a battery backup.

Figure 1. Application Diagram

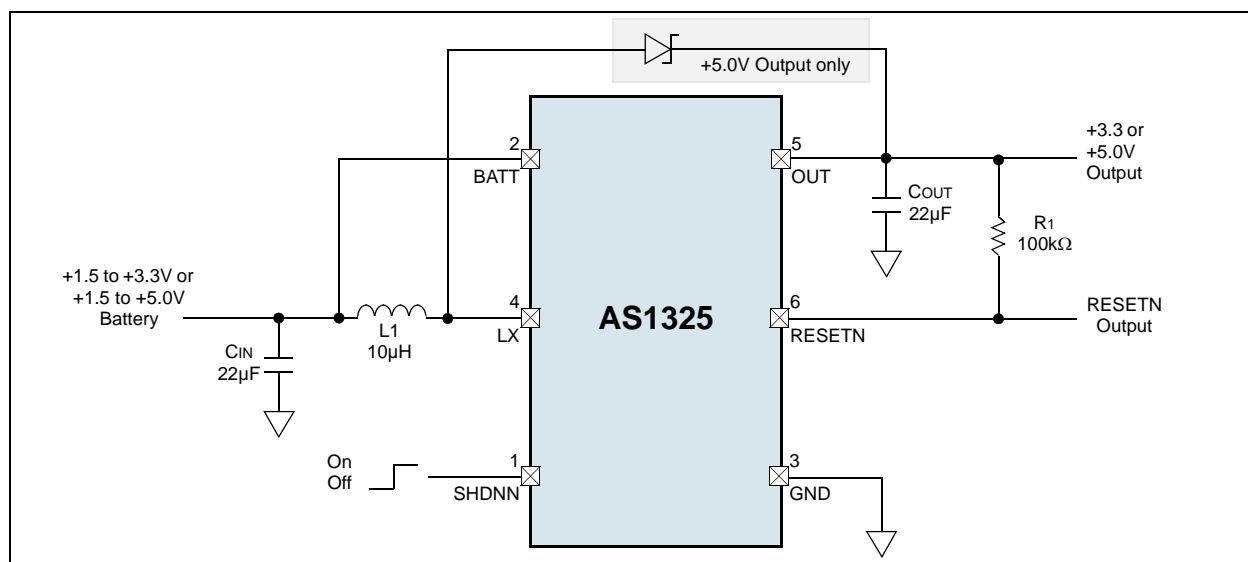

4 Pinout

Pin Assignments

Figure 2. Pin Assignments (Top View)

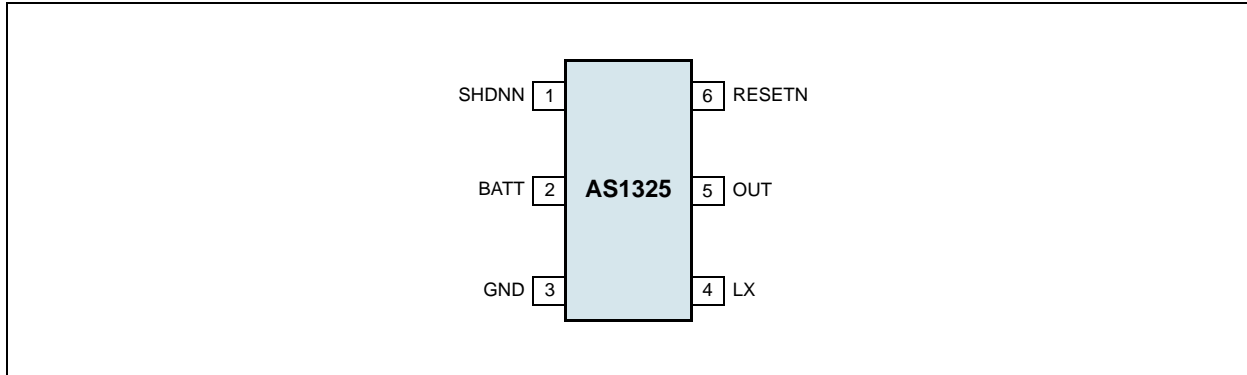

Pin Descriptions

Table 1. Pin Descriptions

Name	Pin Number	Description
SHDNN	1	Active-Low Logic Shutdown Input 0 = The AS1325 is off and the supply current is $\leq 1\mu\text{A}$ (typ). 1 = The AS1325 is on.
BATT	2	Battery Voltage Input
GND	3	Ground
LX	4	External Inductor Connection
OUT	5	Output Voltage
RESETN	6	Active-Low reset output

5 Absolute Maximum Ratings

Stresses beyond those listed in [Table 2](#) may cause permanent damage to the device. These are stress ratings only, and functional operation of the device at these or any other conditions beyond those indicated in [Section 6 Electrical Characteristics on page 4](#) is not implied. Exposure to absolute maximum rating conditions for extended periods may affect device reliability.

Table 2. Absolute Maximum Ratings

Parameter	Min	Max	Units	Comments
All Pins to GND	-0.3	7	V	
LX Current		1	A	
Latch-Up	-100	100	mA	JEDEC 78
Package Power Dissipation ($T_{AMB} = +70^{\circ}\text{C}$)		500	mW	($\Theta_{JA} = 9.1\text{mW}/^{\circ}\text{C}$ above $+70^{\circ}\text{C}$)
Operating Temperature Range	-40	+85	$^{\circ}\text{C}$	
Electrostatic Discharge	-500	+500	V	HBM MIL-Std. 883E 3015.7 methods
Humidity (Non-Condensing)	5	85	%	
Storage Temperature Range	-55	125	$^{\circ}\text{C}$	
Junction Temperature		150	$^{\circ}\text{C}$	
Package Body Temperature		260	$^{\circ}\text{C}$	The reflow peak soldering temperature (body temperature) specified is in compliance with IPC/JEDEC J-STD-020C "Moisture/ Reflow Sensitivity Classification for Non-Hermetic Solid State Surface Mount Devices".

6 Electrical Characteristics

3.3V Output

$T_{AMB} = -40$ to $+85^{\circ}\text{C}$, $V_{BATT} = +2\text{V}$, $V_{OUT} = +3.3$, $V_{SHDNN} = +1.5\text{V}$ (unless otherwise specified). Typ values @ $T_{AMB} = +25^{\circ}\text{C}$.

Table 3. Electrical Characteristics

Parameter	Symbol	Conditions	Min	Typ	Max	Unit
Battery Input Range	V_{BATT}		1.5		3.5	V
Startup Battery Input Voltage ¹	V_{SU}	$R_{LOAD} = 47\Omega$, $T_{AMB} = +25^{\circ}\text{C}$		1.22	1.5	V
		$R_{LOAD} = 47\Omega$, $T_{AMB} = -40$ to $+85^{\circ}\text{C}$		1.24		
Output Voltage ²	V_{OUT}	$T_{AMB} = +25^{\circ}\text{C}$	3.267	3.300	3.333	V
		$T_{AMB} = -40$ to $+85^{\circ}\text{C}$	3.217		3.373	
N-Channel On-Resistance	R_{NCH}	$I_{LX} = 100\text{mA}$, $T_{AMB} = +25^{\circ}\text{C}$		0.3	1.2	Ω
		$I_{LX} = 100\text{mA}$, $T_{AMB} = -40$ to $+85^{\circ}\text{C}$			1.5	
P-Channel On-Resistance	R_{PCH}	$I_{LX} = 100\text{mA}$, $T_{AMB} = +25^{\circ}\text{C}$		0.4	1.3	Ω
		$I_{LX} = 100\text{mA}$, $T_{AMB} = -40$ to $+85^{\circ}\text{C}$			1.6	
Light Load N-Channel Switch Current Limit				400		mA
Maximum N-Channel Switch Current Limit ¹	I_{MAX}	$T_{AMB} = +25^{\circ}\text{C}$	550	700	850	mA
		$T_{AMB} = -40$ to $+85^{\circ}\text{C}$	450		950	
N-Channel Maximum On-Time	t_{ON}	$T_{AMB} = +25^{\circ}\text{C}$	5	7	9	μs
		$T_{AMB} = -40$ to $+85^{\circ}\text{C}$	4		10	
P-Channel Minimum On-Time				2		μs
Synchronous Rectifier Zero-Crossing Current		$T_{AMB} = +25^{\circ}\text{C}$	8	30	60	mA
		$T_{AMB} = -40$ to $+85^{\circ}\text{C}$	0		65	
Quiescent Current into OUT		$V_{OUT} = +3.5\text{V}$, $T_{AMB} = +25^{\circ}\text{C}$		35	55	μA
		$V_{OUT} = +3.5\text{V}$, $T_{AMB} = -40$ to $+85^{\circ}\text{C}$			60	
Shutdown Current into OUT		$V_{SHDNN} = 0\text{V}$, $T_{AMB} = +25^{\circ}\text{C}$		0.01	1	μA
		$V_{SHDNN} = 0\text{V}$, $T_{AMB} = -40$ to $+85^{\circ}\text{C}$			2	
Shutdown Current into BATT		$V_{SHDNN} = 0\text{V}$, $T_{AMB} = +25^{\circ}\text{C}$		0.01	1	μA
		$V_{SHDNN} = 0\text{V}$, $T_{AMB} = -40$ to $+85^{\circ}\text{C}$			2	
SHDNN Logic Low ¹		$V_{BATT} = +1.5$ to $+3.5\text{V}$			0.3	V
SHDNN Threshold		Rising Edge, $T_{AMB} = +25^{\circ}\text{C}$	1.185	1.228	1.271	V
		Rising Edge, $T_{AMB} = -40$ to $+85^{\circ}\text{C}$	1.170		1.286	
SHDNN Threshold Hysteresis				0.02		V
RESETN Threshold		Falling Edge, $T_{AMB} = +25^{\circ}\text{C}$	2.830	3.000	3.110	V
		Falling Edge, $T_{AMB} = -40$ to $+85^{\circ}\text{C}$	2.800		3.140	
RESETN Voltage Low		$I_{RESETN} = 1\text{mA}$, $V_{OUT} = +2.5\text{V}$, $T_{AMB} = +25^{\circ}\text{C}$			0.15	V
		$I_{RESETN} = 1\text{mA}$, $V_{OUT} = +2.5\text{V}$, $T_{AMB} = -40$ to $+85^{\circ}\text{C}$			0.2	
RESETN Leakage Current		$V_{RESETN} = +5.5\text{V}$, $T_{AMB} = +25^{\circ}\text{C}$		0.1	100	nA
		$V_{RESETN} = +5.5\text{V}$, $T_{AMB} = +85^{\circ}\text{C}$		1		
LX Leakage Current		$T_{AMB} = +25^{\circ}\text{C}$		0.1	1000	nA
		$T_{AMB} = +85^{\circ}\text{C}$		10		
Maximum Load Current	I_{LOAD}	$V_{BATT} = +2\text{V}$		300		mA
Efficiency	η	$V_{BATT} = +3\text{V}$, $I_{LOAD} = 100\text{mA}$		96		%

1. Guaranteed by design.

2. Voltage which triggers next loading cycle. Ripple and rms value depend on external components.

5.0V Output

$T_{AMB} = -40$ to $+85^{\circ}\text{C}$, $V_{BATT} = +2\text{V}$, $V_{OUT} = +5.0$, $V_{SHDNN} = +1.5\text{V}$ (unless otherwise specified). Typ values @ $T_{AMB} = +25^{\circ}\text{C}$.

Table 4. Electrical Characteristics

Parameter	Symbol	Conditions	Min	Typ	Max	Unit
Battery Input Range	V_{BATT}		1.5		5.0	V
Startup Battery Input Voltage ¹	V_{SU}	$R_{LOAD} = 100\Omega$, $T_{AMB} = +25^{\circ}\text{C}$		1.22	1.5	V
		$R_{LOAD} = 100\Omega$, $T_{AMB} = -40$ to $+85^{\circ}\text{C}$		1.24		
Output Voltage ²	V_{OUT}	$T_{AMB} = +25^{\circ}\text{C}$	4.950	5.000	5.050	V
		$T_{AMB} = -40$ to $+85^{\circ}\text{C}$	4.875		5.125	
N-Channel On-Resistance	R_{NCH}	$I_{LX} = 100\text{mA}$, $T_{AMB} = +25^{\circ}\text{C}$		0.3	1.2	Ω
		$I_{LX} = 100\text{mA}$, $T_{AMB} = -40$ to $+85^{\circ}\text{C}$			1.5	
P-Channel On-Resistance	R_{PCH}	$I_{LX} = 100\text{mA}$, $T_{AMB} = +25^{\circ}\text{C}$		0.4	1.3	Ω
		$I_{LX} = 100\text{mA}$, $T_{AMB} = -40$ to $+85^{\circ}\text{C}$			1.6	
Light Load N-Channel Switch Current Limit				400		mA
N-Channel Switch Current Limit ¹	I_{MAX}	$T_{AMB} = +25^{\circ}\text{C}$	550	700	850	mA
		$T_{AMB} = -40$ to $+85^{\circ}\text{C}$	450		950	
Switch Maximum On-Time	t_{ON}	$T_{AMB} = +25^{\circ}\text{C}$	5	7	9	μs
		$T_{AMB} = -40$ to $+85^{\circ}\text{C}$	4		10	
P-Channel Minimum On-Time				1		μs
Synchronous Rectifier Zero-Crossing Current		$T_{AMB} = +25^{\circ}\text{C}$	8	30	60	mA
		$T_{AMB} = -40$ to $+85^{\circ}\text{C}$	0		65	
Quiescent Current into OUT		$V_{OUT} = +5.5\text{V}$, $T_{AMB} = +25^{\circ}\text{C}$		35	55	μA
		$V_{OUT} = +5.5\text{V}$, $T_{AMB} = -40$ to $+85^{\circ}\text{C}$			60	
Shutdown Current into OUT		$V_{SHDNN} = 0\text{V}$, $T_{AMB} = +25^{\circ}\text{C}$		0.01	1	μA
		$V_{SHDNN} = 0\text{V}$, $T_{AMB} = -40$ to $+85^{\circ}\text{C}$			2	
Shutdown Current into BATT		$V_{SHDNN} = 0\text{V}$, $T_{AMB} = +25^{\circ}\text{C}$		0.01	1	μA
		$V_{SHDNN} = 0\text{V}$, $T_{AMB} = -40$ to $+85^{\circ}\text{C}$			2	
SHDNN Logic Low ¹		$V_{BATT} = +1.5$ to $+5.0\text{V}$			0.3	V
SHDNN Threshold		Rising Edge, $T_{AMB} = +25^{\circ}\text{C}$	1.185	1.228	1.271	V
		Rising Edge, $T_{AMB} = -40$ to $+85^{\circ}\text{C}$	1.170		1.286	
SHDNN Threshold Hysteresis				0.02		V
RESETN Threshold		Falling Edge, $T_{AMB} = +25^{\circ}\text{C}$	4.288	4.500	4.712	V
		Falling Edge, $T_{AMB} = -40$ to $+85^{\circ}\text{C}$	4.242		4.758	
RESETN Voltage Low		$I_{RESETN} = 1\text{mA}$, $V_{OUT} = +2.5\text{V}$, $T_{AMB} = +25^{\circ}\text{C}$			0.15	V
		$I_{RESETN} = 1\text{mA}$, $V_{OUT} = +2.5\text{V}$, $T_{AMB} = -40$ to $+85^{\circ}\text{C}$			0.2	
RESETN Leakage Current		$V_{RESETN} = +5.5\text{V}$, $T_{AMB} = +25^{\circ}\text{C}$		0.1	100	nA
		$V_{RESETN} = +5.5\text{V}$, $T_{AMB} = +85^{\circ}\text{C}$		1		
LX Leakage Current		$T_{AMB} = +25^{\circ}\text{C}$		0.1	1000	nA
		$T_{AMB} = +85^{\circ}\text{C}$		10		
Maximum Load Current	I_{LOAD}	$V_{BATT} = +2\text{V}$		185		mA
Efficiency	η	$V_{BATT} = +3\text{V}$, $I_{LOAD} = 100\text{mA}$		91		%

1. Guaranteed by design.

2. Voltage which triggers next loading cycle. Ripple and rms value depend on external components.

7 Typical Operating Characteristics

3.3V Characteristics

$V_{OUT} = 3.3V$, $V_{BATT} = +2V$, $T_{AMB} = +25^{\circ}C$, $10\mu H$ (MOS6020-103ML) Inductor, $22\mu F$ (C1210C226K9PAK) C_{IN} and C_{OUT}

Figure 3. V_{OUT} vs. V_{BATT} ; On, 16Ω

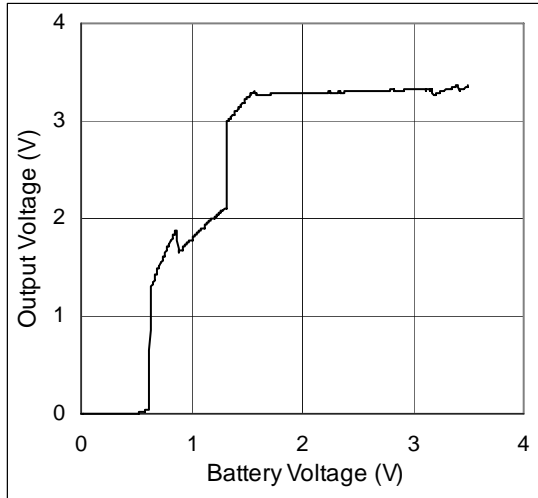

Figure 4. V_{OUT} vs. V_{BATT} ; On, 330Ω

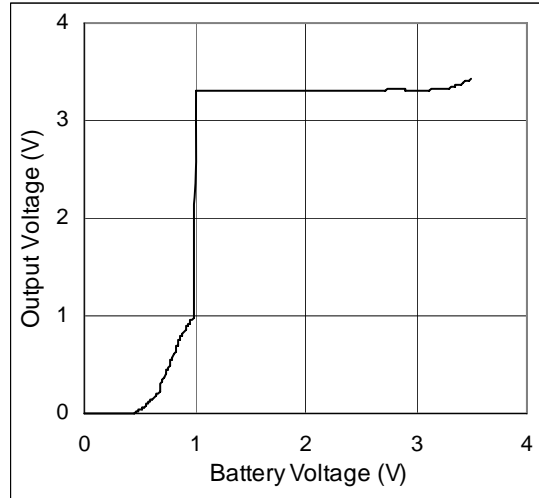

Figure 5. V_{OUT} vs. V_{BATT} ; Shutdown, $300mA$ Load

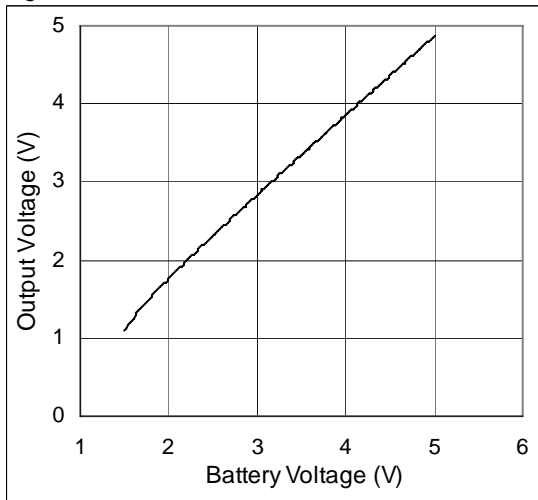

Figure 6. V_{OUT} vs. V_{BATT} ; Shutdown, No Load

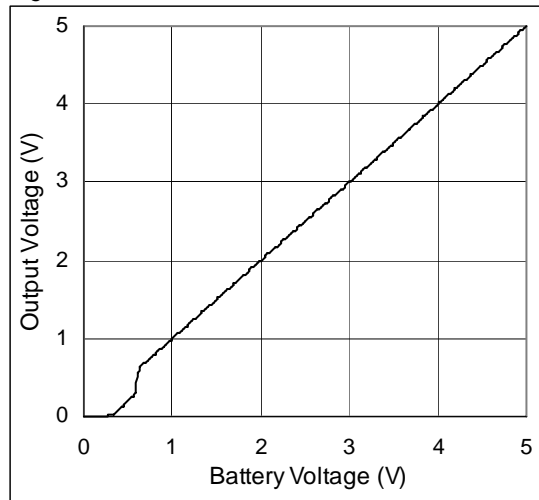

Figure 7. Maximum Output Current vs. V_{BATT}

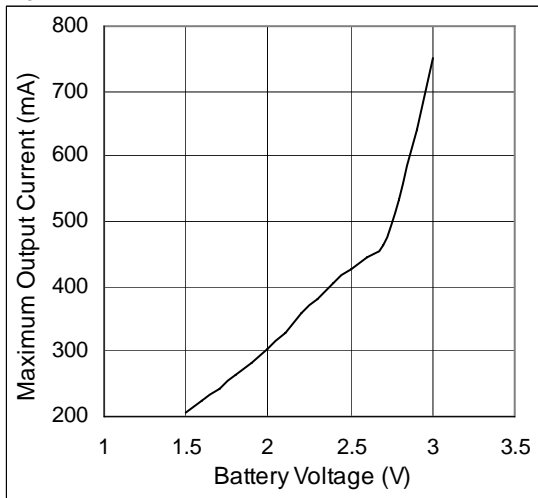

Figure 8. Startup Voltage vs. Load Resistance

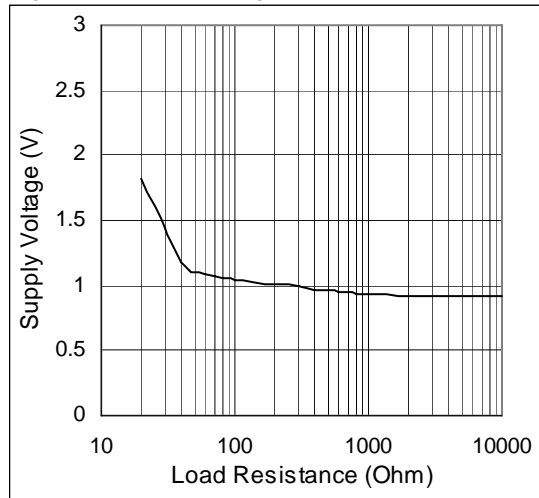

Figure 9. Line Transient

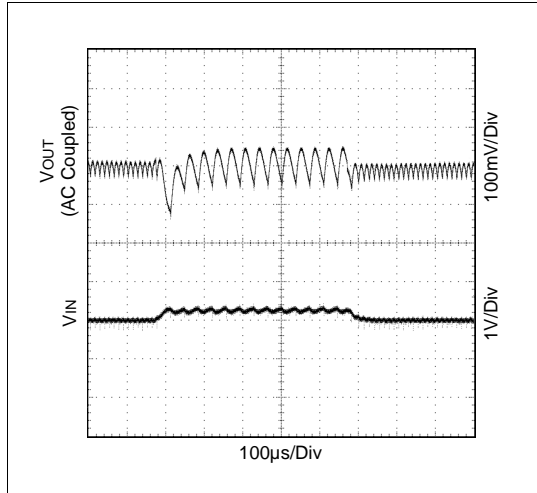

Figure 10. Load Transient

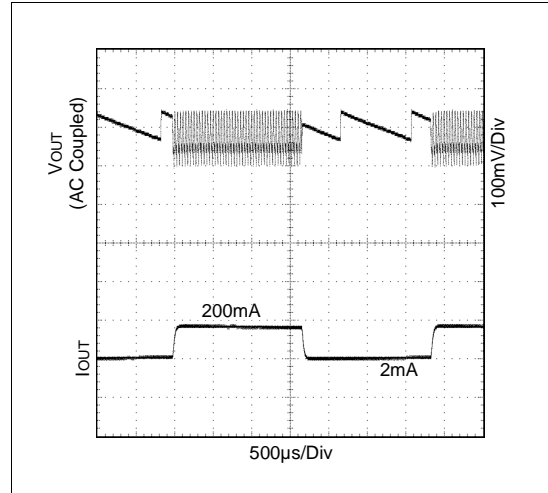

Figure 11. On/Off Response; $R_{LOAD} = 33\Omega$

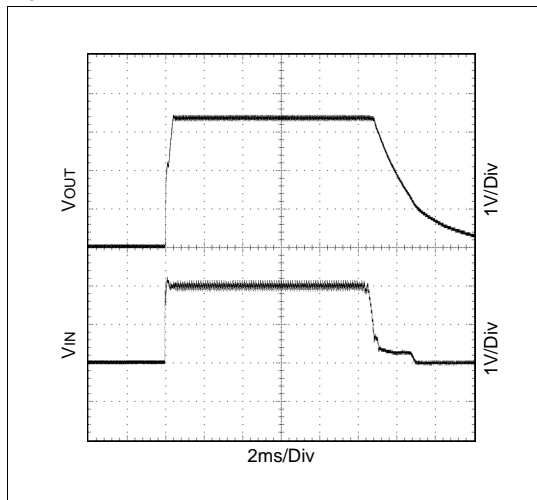

Figure 12. Shutdown Response; $R_{LOAD} = 33\Omega$

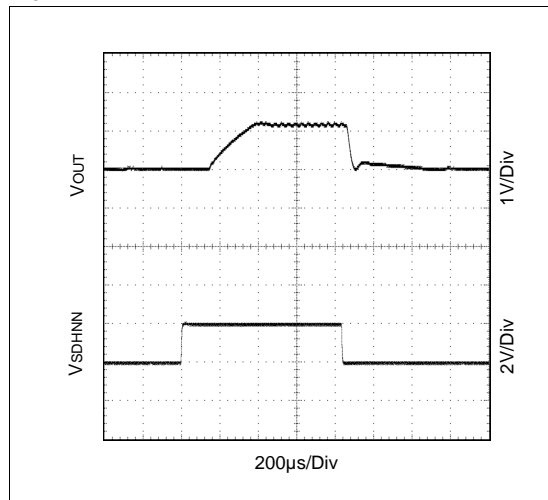

Figure 13. Waveforms; $R_{LOAD} = 33\Omega$

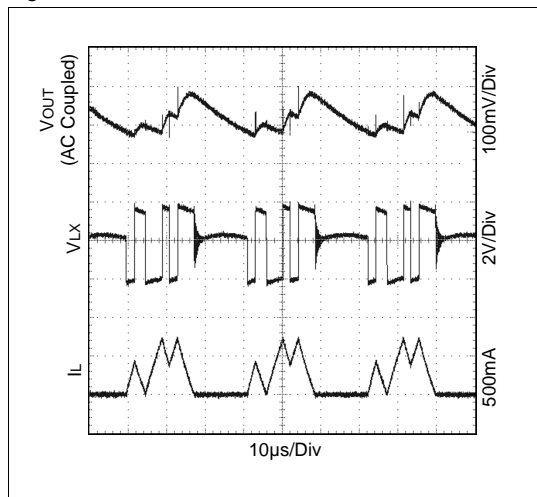
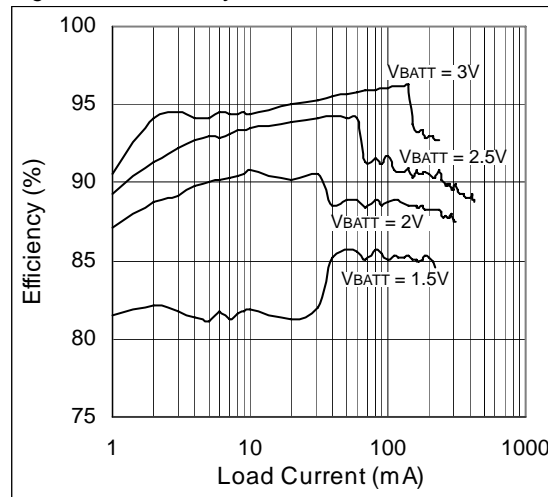

Figure 14. Efficiency vs. Load Current



5.0V Characteristics

$V_{OUT} = 5.0V$, $V_{BATT} = +2V$, $T_{AMB} = +25^{\circ}C$, $10\mu H$ (MOS6020-103ML) Inductor, $22\mu F$ (C1210C226K9PAK) C_{IN} and C_{OUT}

Figure 15. V_{OUT} vs. V_{BATT} ; On, 39Ω

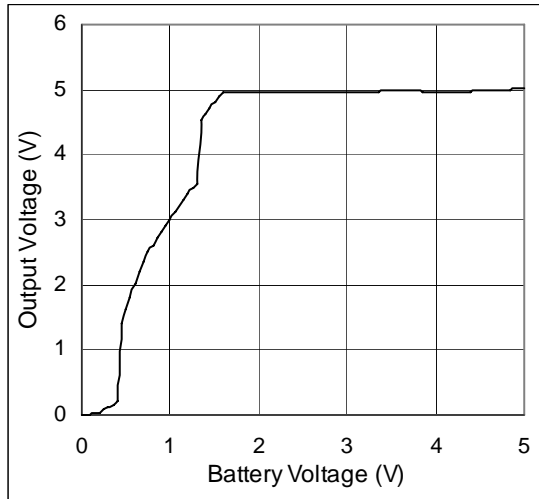

Figure 16. V_{OUT} vs. V_{BATT} ; On, 470Ω

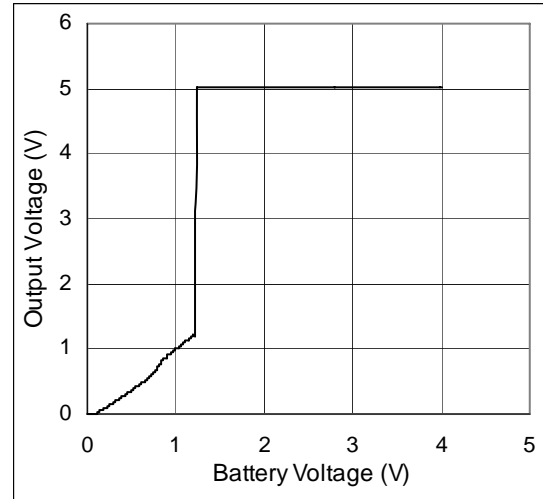

Figure 17. V_{OUT} vs. V_{BATT} ; Shutdown, $180mA$ Load

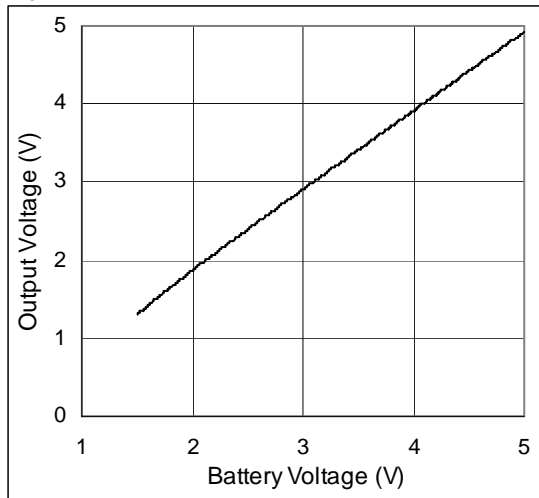

Figure 18. V_{OUT} vs. V_{BATT} ; Shutdown, No Load

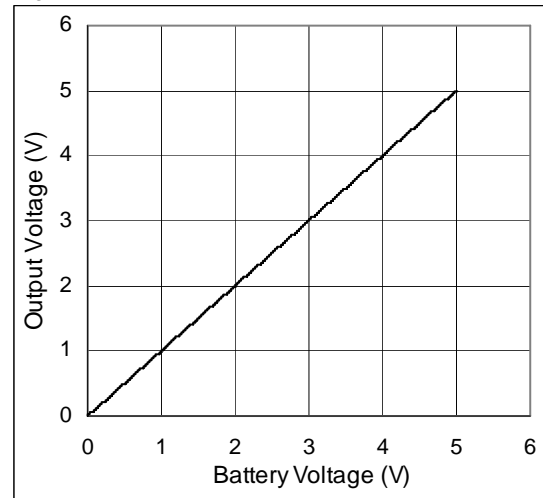

Figure 19. Maximum Output Current vs. V_{BATT}

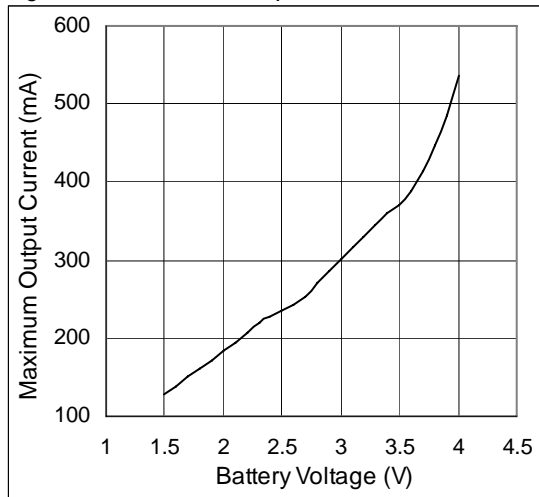

Figure 20. Startup Voltage vs. Load Resistance

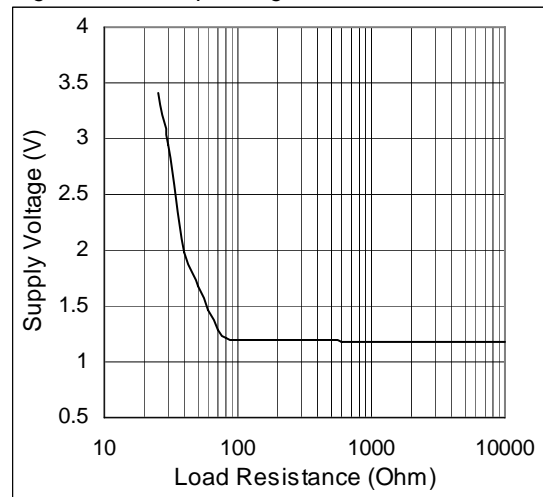

Figure 21. Line Transient

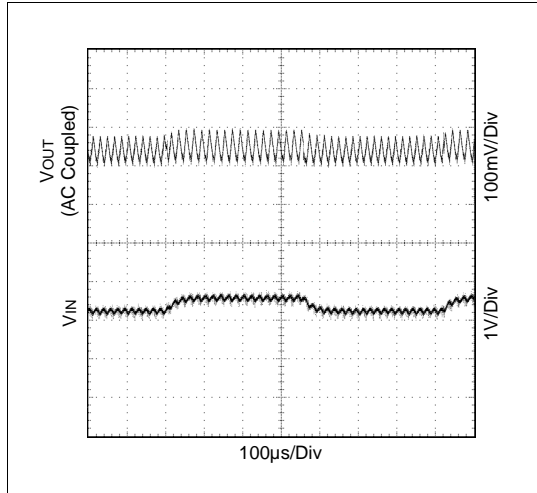

Figure 22. Load Transient

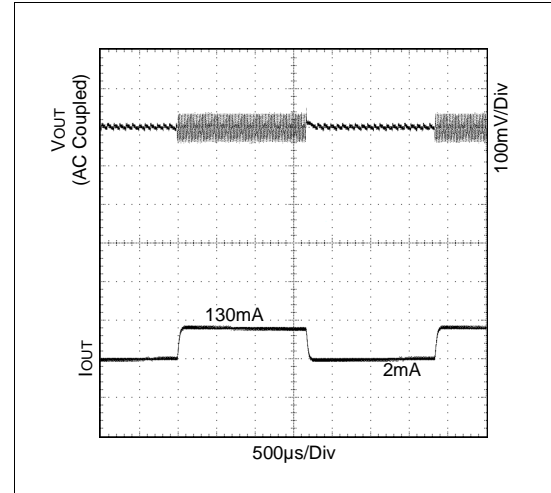

Figure 23. On/Off Response; $R_{LOAD} = 100\Omega$

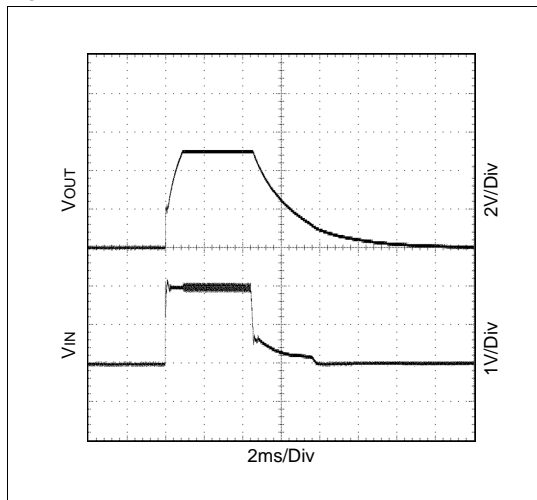

Figure 24. Shutdown Response; $R_{LOAD} = 100\Omega$

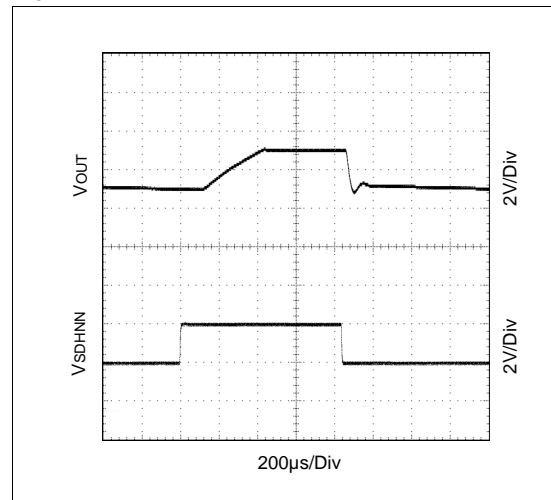

Figure 25. Waveforms; $R_{LOAD} = 68\Omega$

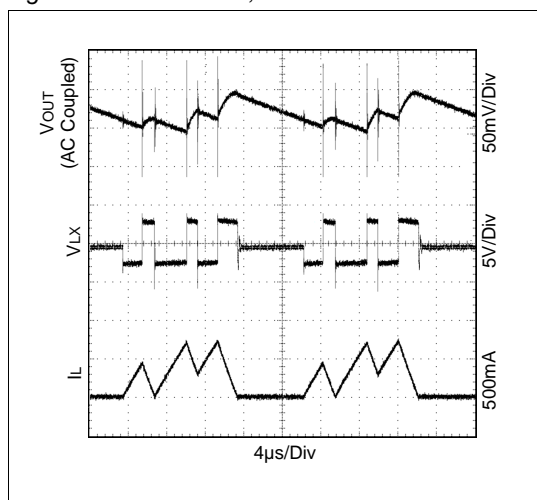
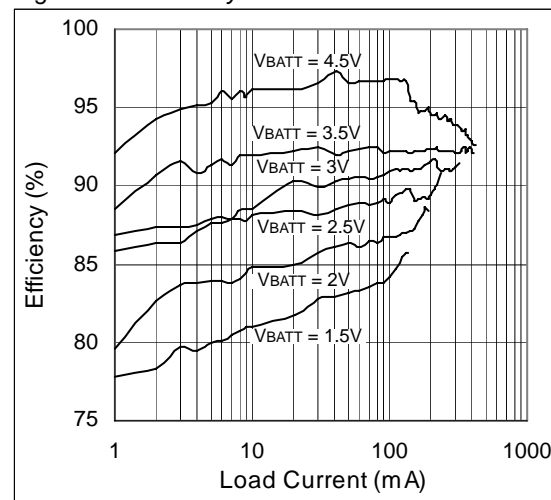

Figure 26. Efficiency vs. Load Current



8 Detailed Description

The AS1325 is a high-efficiency, compact step-up converter with 35 μ A quiescent supply current which ensures the highest efficiency over a wide load range. With a minimum of +1.5V input voltage, the device is well suited for applications with one- or two-cells, such as lithium ion (Li+), nickel-metal-hydride (NiMH), or alkaline.

Figure 27. Block Diagram

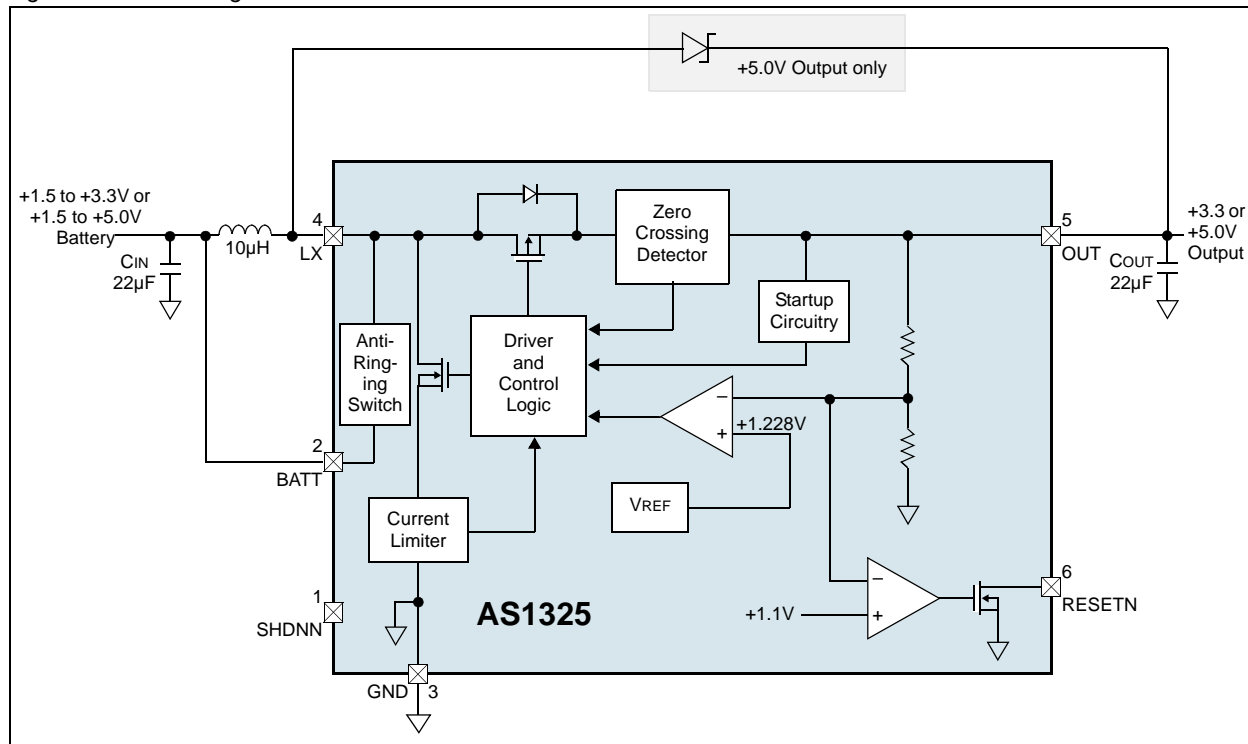

The input battery is connected to the device through an inductor and an internal P-FET when pin SHDNN is low. In this state, the step-up converter is off and the voltage drop across the P-FET body diode is eliminated, and the input battery can be used as a battery-backup or real-time-clock supply.

The built-in synchronous rectifier significantly improves efficiency.

Control Circuitry

The AS1325 integrated current-limited key circuitry provides low quiescent current and extremely-high efficiency over a wide V_{OUT} range without the need for an oscillator.

Light Loads:

Inductor current is limited by the 0.4A N-channel current limit or by the 7 μ s switch maximum on-time. The lower current limit reduces the ripple of the output voltage. At each cycle, the inductor current must ramp down to zero before the next cycle may start. When the error comparator senses that the output has fallen below the regulation threshold, another cycle begins.

Higher Loads:

If after the first light load cycle the output voltage has not reached its target value of 3.3V or 5.0V, the inductor current limit is increased to 0.7A. After the P-channel minimum on-time the next loading cycle is started if the output voltage is still below its target value. If the target value is reached, the inductor current must ramp down to zero before the next cycle may start. When the error comparator senses that the output has fallen below the regulation threshold, another load cycle begins (see [Figure 13 on page 7](#) and [Figure 25 on page 9](#)).

Shutdown

When pin SHDNN is low the AS1325 is switched off and no current is drawn from battery; when pin SHDNN is high the device is switched on. If SHDNN is driven from a logic-level output, the logic high-level (on) should be referenced to VOUT to avoid intermittently switching the device on.

Note: If pin SHDNN is not used, it should be connected directly to pin OUT.

In shutdown the battery input is connected to the output through the inductor and the internal synchronous rectifier P-FET. This allows the input battery to provide backup power for devices such as an idle microcontroller, memory, or real-time-clock, without the usual diode forward drop. In this way a separate backup battery is not needed.

In cases where there is residual voltage during shutdown, some small amount of energy will be transferred from pin OUT to pin BATT immediately after shutdown, resulting in a momentary spike of the voltage at pin BATT. The ratio of CIN and COUT partly determine the size and duration of this spike, as does the current-sink ability of the input device.

Low-Battery Cutoff

The AS1325 SHDNN trip threshold (1.228V) can be used as an input voltage detector that disables the device when the battery input voltage falls to a pre-set level. An external resistor-divider network can be used to set the battery-detection voltage (see Figure 28).

Figure 28. Low-Battery Cutoff Application Diagram

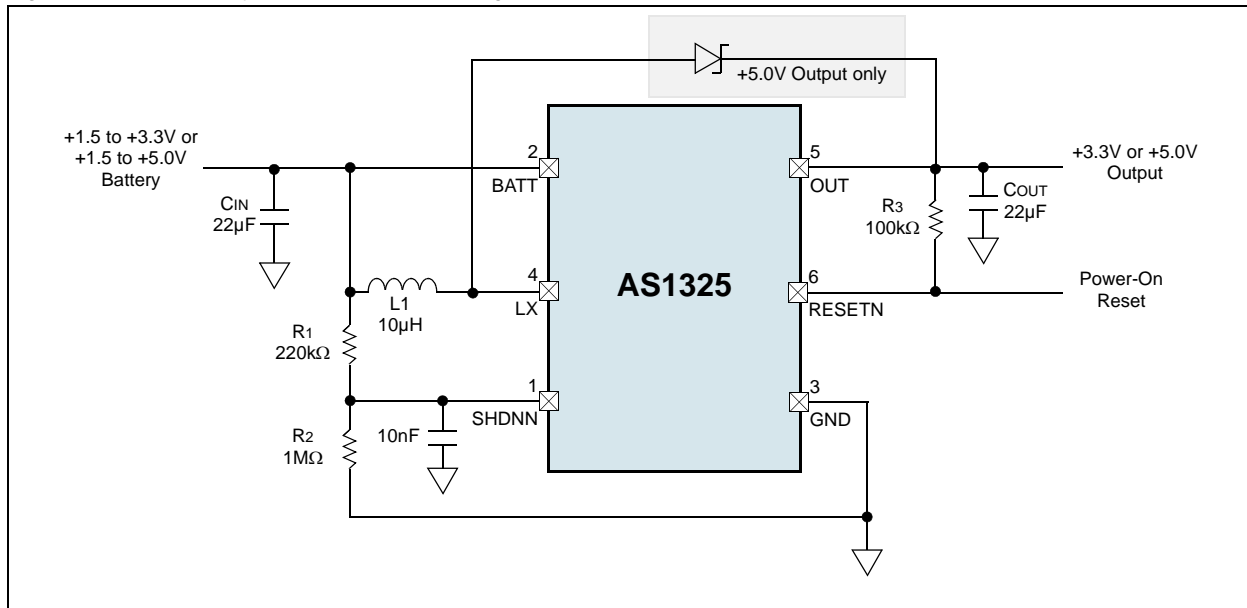

For the resistor-divider network shown in Figure 28, calculate the value for R1 by:

$$R1 = R2 \times ((V_{OFF}/V_{SHDNN}) - 1) \quad (EQ 1)$$

Where:

V_{OFF} is the battery voltage at which the AS1325 shuts down.

$V_{SHDNN} = 1.228V$

The value of R2 should be between 100kΩ and 1MΩ to minimize battery drain.

Note: Input ripple can cause false shutdowns, therefore to minimize the effect of ripple, a low-value capacitor from SHDNN to GND should be used to filter out input noise. The value of the capacitor should be such that the R/C time constant is $> 2ms$.

Power-On Reset

The AS1325 provides a power-on reset output (RESETN) that goes high-impedance when the output reaches 90% of its regulation point. RESETN goes low when the output is below 90% of the regulation point. A 100k Ω to 1M Ω pullup resistor between pin RESETN and pin OUT can provide a microprocessor logic control signal.

Note: Connect pin RESETN to GND when the power-on reset feature is not used.

Antiringing Control

If the inductor current falls to zero, an internal 100 Ω (typ) antiringing switch is connected from LX to BATT to minimize EMI. The antiringing control can be deactivated by not connecting the pin BATT. The device is supplied by the pin OUT - no supply current flows into pin BATT.

9 Application Information

Inductor Selection

The control circuitry of the AS1325 permits a wide range of inductor values to be selected – from 4.7 to 22 μ H; The system is optimized for 10 μ H.

The intended application should dictate the value of L. The trade-off between required PCB surface area and desired output ripple are the determining factors: smaller values for L require less PCB space, larger values of L reduce output ripple. If the value of L is large enough to prevent I_{MAX} from being reached before t_{ON} expires, the AS1325 output power will be reduced.

Note: Coils should be able to handle 500mARMS and have a I_{SAT} \geq 1A and should have a R_{IND} \leq 100m Ω .

Table 5. Recommended Inductors

Part Number	L	DCR	Current Rating	Dimensions (L/W/T)	Manufacturer
MOS6020-103ML	10 μ H	93m Ω	1A	6.8x6.0x2.4mm	Coilcraft www.coilcraft.com
MOS6020-472ML	4.7 μ H	50m Ω	1.5A	6.8x6.0x2.4mm	
MOS6020-332ML	3.3 μ H	46m Ω	1.8A	6.8x6.0x2.4mm	
CDRH4D18-100	10 μ H	200m Ω	0.61A	6.9x5.0x2.0mm	Sumida www.sumida.com
CDRH4D18-6R8	6.8 μ H	200m Ω	0.76A	6.9x5.0x2.0mm	
CR43-6R8	6.8 μ H	131.2m Ω	0.95A	4.8x4.3x3.5mm	
CDRH4D18-4R7	4.7 μ H	162m Ω	0.84A	6.9x5.0x2.0mm	
SD0403-6R8M	6.8 μ H	132m Ω	0.95A	4.9x4.5x3.2mm	ACT www.act1.com
SD0403-4R7M	4.7 μ H	109m Ω	1.15A	4.9x4.5x3.2mm	

Figure 29. Efficiency Comparison of Different Inductors; V_{IN} = 2.5V, V_{OUT} = 3.3V

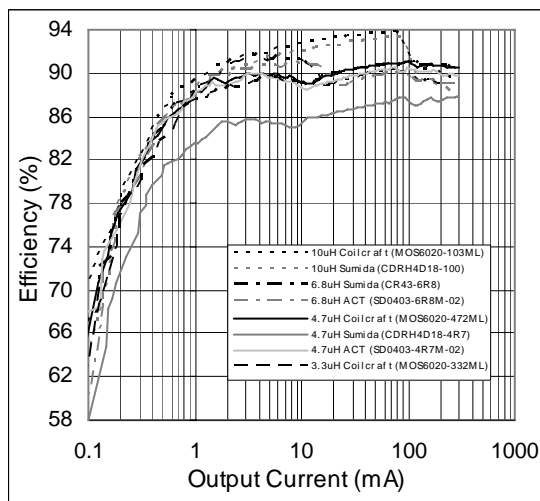
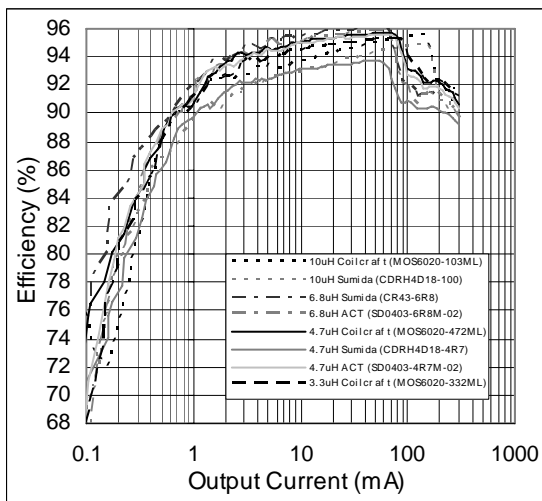

Figure 30. Efficiency Comparison of Different Inductors; V_{IN} = 3.0V, V_{OUT} = 3.3V



Capacitor Selection

Low ESR capacitors (X5R or X7R) should be used to minimize the output voltage ripple.

C_{OUT} Selection

Choose a C_{OUT} value to achieve the desired output ripple. A 22 μ F ceramic capacitor is a good initial value. A larger value for C_{OUT} can be used to further reduce ripple and improve AS1325 efficiency.

Table 6. Recommended Output Capacitor

Part Number	C	TC Code	Rated Voltage	Dimensions (L/W/T)	Manufacturer
C1210C226K9PAK	22 μ F \pm 10%	X5R	6.3V	3.2x2.5x1.5mm	Kemet www.kemet.com
JMK212BJ226MG-T	22 μ F \pm 20%	X5R	6.3V	2x1.3x1.3mm	Taiyo Yuden www.t-yuden.com

C_{IN} Selection

C_{IN} reduces the peak current drawn from the battery and can be the same value as C_{OUT}.

Table 7. Recommended Input Capacitor

Part Number	C	TC Code	Rated Voltage	Dimensions (L/W/T)	Manufacturer
C1210C226K9PAK	22 μ F \pm 10%	X5R	6.3V	3.2x2.5x1.5mm	Kemet www.kemet.com
GRM31CR70J106KA01L	10 μ F \pm 10%	X7R	6.3V	3.2x1.6x1.6mm	Murata www.murata.com

External Diode (5V Output only)

An external Schottky diode must be connected, in parallel with the on-chip synchronous rectifier, from LX to OUT. Use diodes such as MBR0520L, EP05Q03L, or the generic 1N5817. The diode should be rated for 500mA, since it carries current during startup and after the synchronous rectifier turns off. The Schottky diode must be connected as close to the IC as possible. Ordinary rectifier diodes must not be used, since the slow recovery rate will compromise efficiency.

PC Board Layout and Grounding

Well-designed printed circuit-board layout is important for minimizing ground bounce and noise.

- Place pin GND lead and the ground leads of C_{IN} and C_{OUT} as close to the device as possible.
- Keep the lead to pin LX as short as possible.
- To maximize output power and efficiency and minimize output ripple voltage, use a ground plane and solder the GND pin directly to the ground plane.

10 Package Drawings and Markings

The AS1325 is available in a 6-pin SOT23 package.

Figure 31. 6-pin SOT23 Package

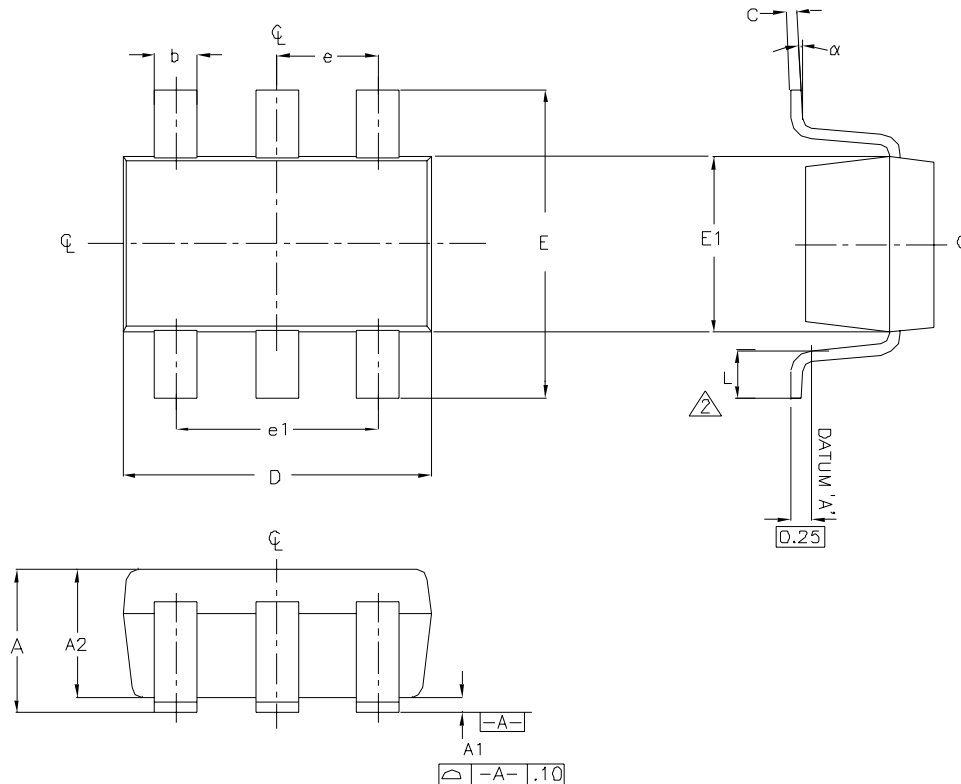

Notes:

1. All dimensions are in millimeters.
2. Foot length is measured at the intercept point between datum A and lead surface.
3. Package outline exclusive of mold flash and metal burr.
4. Pin 1 is the lower left pin when reading the top mark from left to right.
5. Pin 1 identifier dot is 0.3mm.φ min and is located above pin 1.
6. Meets JEDEC MO178.

Symbol	Min	Max
A	0.90	1.45
A1	0.00	0.15
A2	0.90	1.30
b	0.35	0.50
C	0.08	0.20
D	2.80	3.00
E	2.60	3.00
E1	1.50	1.75
L	0.35	0.55
e	0.95 REF	
α	0°	10°

11 Ordering Information

The AS1325 is available as the standard products shown in [Table 8](#).

Table 8. Ordering Information

Part	Marking	Description	Delivery Form	Package
AS1325-BSTT-33	ASKY	300mA Step-Up DC-DC Converter	Tape and Reel	6-pin SOT23
AS1325-BSTT-50	ASK6	185mA Step-Up DC-DC Converter	Tape and Reel	6-pin SOT23

Copyrights

Copyright © 1997-2007, austriamicrosystems AG, Schloss Premstaetten, 8141 Unterpremstaetten, Austria-Europe. Trademarks Registered ®. All rights reserved. The material herein may not be reproduced, adapted, merged, translated, stored, or used without the prior written consent of the copyright owner.

All products and companies mentioned are trademarks or registered trademarks of their respective companies.

Disclaimer

Devices sold by austriamicrosystems AG are covered by the warranty and patent indemnification provisions appearing in its Term of Sale. austriamicrosystems AG makes no warranty, express, statutory, implied, or by description regarding the information set forth herein or regarding the freedom of the described devices from patent infringement. austriamicrosystems AG reserves the right to change specifications and prices at any time and without notice. Therefore, prior to designing this product into a system, it is necessary to check with austriamicrosystems AG for current information. This product is intended for use in normal commercial applications. Applications requiring extended temperature range, unusual environmental requirements, or high reliability applications, such as military, medical life-support or life-sustaining equipment are specifically not recommended without additional processing by austriamicrosystems AG for each application. For shipments of less than 100 parts the manufacturing flow might show deviations from the standard production flow, such as test flow or test location.

The information furnished here by austriamicrosystems AG is believed to be correct and accurate. However, austriamicrosystems AG shall not be liable to recipient or any third party for any damages, including but not limited to personal injury, property damage, loss of profits, loss of use, interruption of business or indirect, special, incidental or consequential damages, of any kind, in connection with or arising out of the furnishing, performance or use of the technical data herein. No obligation or liability to recipient or any third party shall arise or flow out of austriamicrosystems AG rendering of technical or other services.



Contact Information

Headquarters

austriamicrosystems AG
A-8141 Schloss Premstaetten, Austria

Tel: +43 (0) 3136 500 0
Fax: +43 (0) 3136 525 01

For Sales Offices, Distributors and Representatives, please visit:

<http://www.austriamicrosystems.com/contact>