

# AS1374

## Dual 200mA, Low-Noise, High-PSRR, Low Dropout Regulators

### 1 General Description

The AS1374 is a low-noise, low-dropout linear regulator with two separated outputs. Designed to deliver 200mA continuous output current at each output pin, the LDOs can achieve a low 120mV dropout for 200mA load current and are designed and optimized to work with low-cost, small-capacitance ceramic capacitors.

An integrated P-channel MOSFET pass transistor allows the devices to maintain extremely low quiescent current (30µA).

The AS1374 uses an advanced architecture to achieve ultra-low output voltage noise of 20µV<sub>RMS</sub> and a power-supply rejection-ratio of better than 85dB (@ 1kHz).

Two active-High enable pins allows to switch on or off each output independently from each other.

The AS1374 requires only 1µF output capacitor for stability at any load.

The device is available in a 6-bump WLP package.

### 2 Key Features

- Preset Output Voltages: 1.2V to 3.6V (in 50mV steps)
- Output Noise: 20µV<sub>RMS</sub> @ 100Hz to 100kHz
- Power-Supply Rejection Ratio: 85dB @ 1kHz
- Low Dropout: 120mV @ 200mA Load
- Stable with 1µF Ceramic Capacitor for any Load
- Guaranteed 200mA output
- Pull-Down Option in Shutdown (factory set)
- Extremely-Low Quiescent Current: 30µA
- Excellent Load/Line Transient
- Overcurrent and Thermal Protection
- 6-bump WLP Package

### 3 Applications

The devices are ideal for mobile phones, wireless phones, PDAs, handheld computers, mobile phone base stations, Bluetooth portable radios and accessories, wireless LANs, digital cameras, personal audio devices, and any other portable, battery-powered application.

Figure 1. AS1374 - Typical Application Circuit

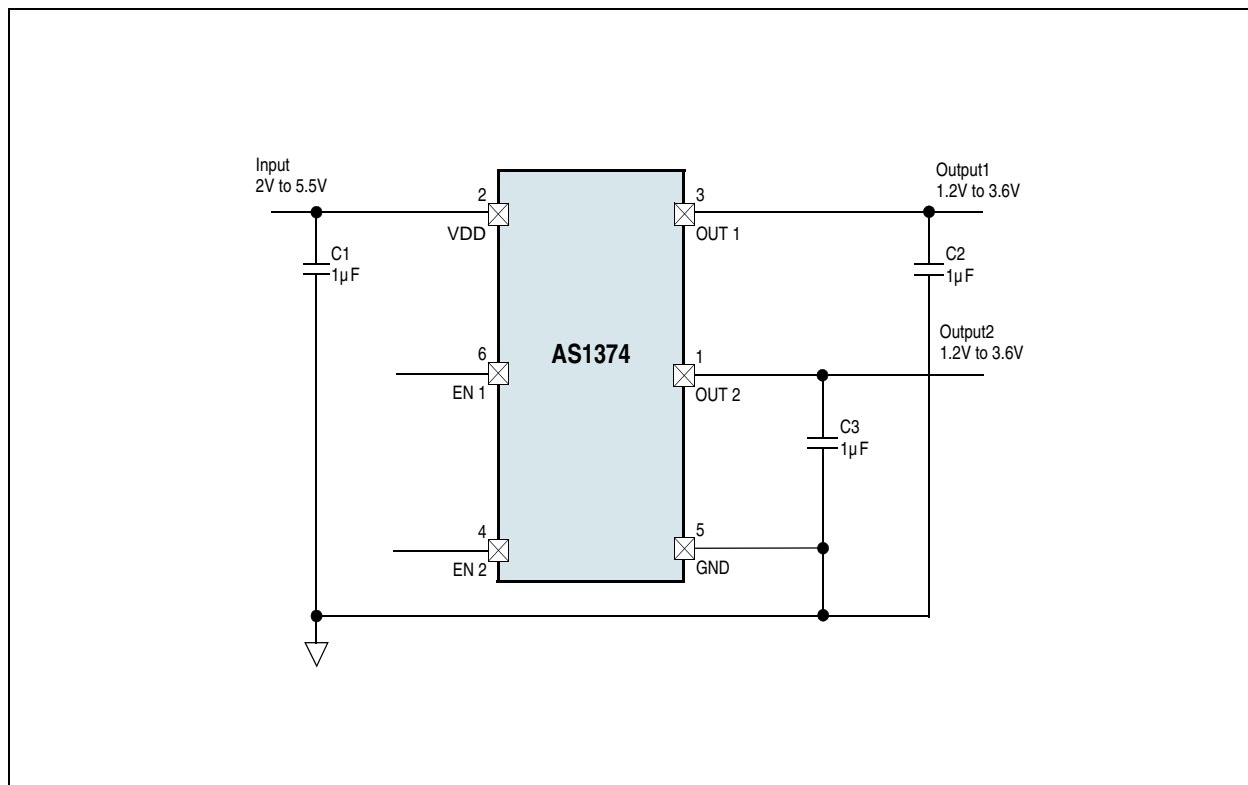

## 4 Pin Assignments

Figure 2. Pin Assignments (Top View)

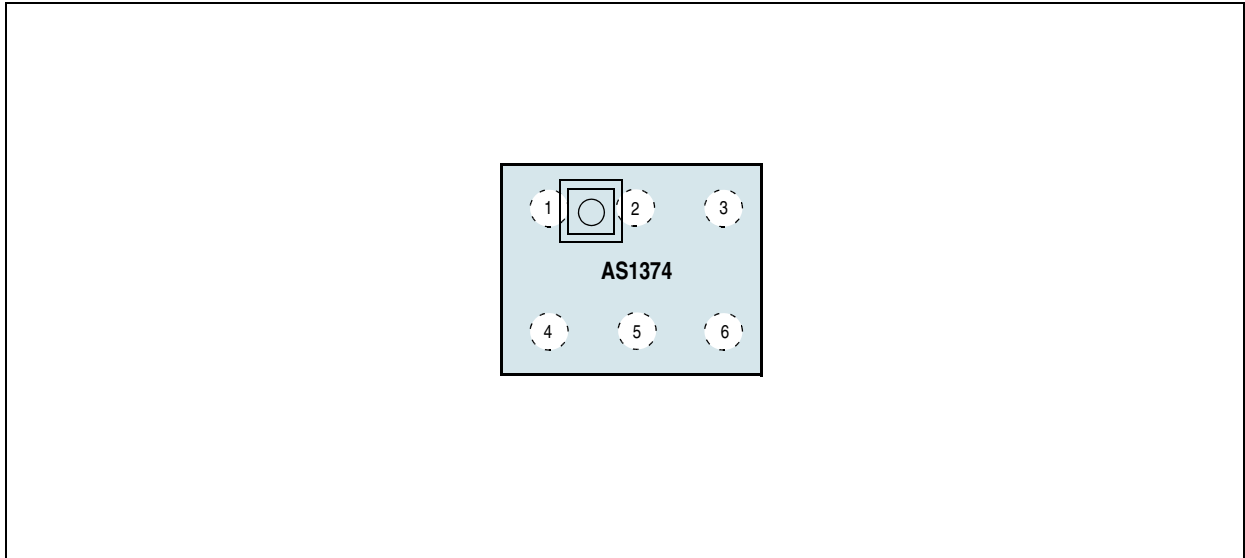

### 4.1 Pin Descriptions

Table 1. Pin Descriptions

Pin Number	Pin Name	Description
1	OUT 2	Regulated Output Voltage 2. Bypass this pin with a capacitor to GND. See <a href="#">Application Information</a> for capacitor selection.
2	VDD	Input Supply
3	OUT 1	Regulated Output Voltage 1. Bypass this pin with a capacitor to GND. See <a href="#">Application Information</a> for capacitor selection.
4	EN 2	Enable 2. Pull this pin to logic low to disable Regulated Output 2 voltage.
5	GND	Ground
6	EN 1	Enable 1. Pull this pin to logic low to disable Regulated Output 1 voltage.

## 5 Absolute Maximum Ratings

Stresses beyond those listed in [Table 2](#) may cause permanent damage to the device. These are stress ratings only, and functional operation of the device at these or any other conditions beyond those indicated in [Electrical Characteristics on page 4](#) is not implied. Exposure to absolute maximum rating conditions for extended periods may affect device reliability.

Table 2. Absolute Maximum Ratings

Parameter	Min	Max	Units	Comments
<b>Electrical Parameters</b>				
VDD to GND	-0.3	7	V	
All other pins to GND	-0.3	VDD + 0.3	V	
Output Short-Circuit Duration		Infinite		
Input Current (latch-up immunity)	-100	100	mA	Norm: JEDEC 78
<b>Electrostatic Discharge</b>				
Electrostatic Discharge HBM		2	kV	Norm: MIL 883 E method 3015
<b>Temperature Ranges and Storage Conditions</b>				
Thermal Resistance $\Theta_{JA}$		201.7	$^{\circ}\text{C}/\text{W}$	Junction-to-ambient thermal resistance is very dependent on application and board-layout. In situations where high maximum power dissipation exists, special attention must be paid to thermal dissipation during board design.
Junction Temperature		+125	$^{\circ}\text{C}$	
Storage Temperature Range	-55	+150	$^{\circ}\text{C}$	
Package Body Temperature		+260	$^{\circ}\text{C}$	The reflow peak soldering temperature (body temperature) specified is in accordance with <i>IPC/JEDEC J-STD-020 "Moisture/Reflow Sensitivity Classification for Non-Hermetic Solid State Surface Mount Devices"</i> .
Humidity non-condensing	5	85	%	

## 6 Electrical Characteristics

$V_{IN} = V_{OUT} + 0.5V$ ,  $V_{OUT} = 2.85V$ ,  $C_{IN} = C_{OUT} = 1\mu F$ , Typical values are at  $T_{AMB} = +25^{\circ}C$  (unless otherwise specified). All limits are guaranteed. The parameters with min and max values are guaranteed with production tests or SQC (Statistical Quality Control) methods.

Table 3. Electrical Characteristics

Symbol	Parameter	Condition	Min	Typ	Max	Unit
T <sub>AMB</sub>	Operating Temperature Range		-40		+85	°C
V <sub>IN</sub>	Input Voltage Range		2		5.5	V
ΔV <sub>OUT</sub>	Output Voltage Accuracy	I <sub>OUT</sub> = 1mA, T <sub>AMB</sub> = +25°C	-1		+1	%
		I <sub>OUT</sub> = 100μA to 200mA, T <sub>AMB</sub> = +25°C	-1.5		+1.5	
		I <sub>OUT</sub> = 100μA to 200mA	-2.5		+2.5	
I <sub>OUT</sub>	Maximum Output Current	Each channel	200			mA
I <sub>GND</sub>	Ground Current	One channel on, I <sub>OUT</sub> = 50μA		25	50	μA
		One channel on, I <sub>OUT</sub> = 200mA		30	55	μA
I <sub>LIMIT</sub>	Current Limit	OUT = short	210	300	400	mA
	Dropout Voltage <sup>1</sup>	2V ≤ V <sub>OUT</sub> < 2.5V, I <sub>OUT</sub> = 100mA		80	150	mV
I <sub>Q</sub>	Quiescent Current	Both channels on, I <sub>OUT</sub> = 0.05mA		30	90	μA
		Both channels ON, V <sub>IN</sub> = V <sub>OUTNOM</sub> - 0.1V, I <sub>OUT</sub> = 0mA		50		
V <sub>LNR</sub>	Line Regulation	V <sub>IN</sub> = (V <sub>OUT</sub> + 0.5V) to 5.5V, I <sub>OUT</sub> = 1mA		0.02		%/V
V <sub>LDR</sub>	Load Regulation	I <sub>OUT</sub> = 1 to 200mA		0.0005		%/mA
I <sub>SHDN</sub>	Shutdown Current	OUT 1 and OUT 2 disable		0.01	2	μA
PSRR	Ripple Rejection	f = 1kHz, I <sub>OUT</sub> = 10mA		85		dB
		f = 10kHz, I <sub>OUT</sub> = 10mA		65		
		f = 100kHz, I <sub>OUT</sub> = 10mA		50		
	Output Noise Voltage (RMS)	f = 100Hz to 100kHz, I <sub>LOAD</sub> = 20mA		20		μV
<b>Enable</b>						
	Enable Input Bias Current			0.01		μA
	Enable Exit Delay <sup>2</sup>	Both channels initially OFF		150		μs
		One channel initially OFF		200		
	Enable Logic Low Level				0.4	V
	Enable Logic High Level		1.4			V
<b>Thermal Protection</b>						
T <sub>SHDN</sub>	Thermal Shutdown Temperature			160		°C
ΔT <sub>SHDN</sub>	Thermal Shutdown Hysteresis			15		°C
C <sub>OUT</sub>	Output Capacitor	Load Capacitor Range	0.47		10	μF
		Maximum ESR Load			500	mΩ

1. Dropout is defined as V<sub>IN</sub> - V<sub>OUT</sub> when V<sub>OUT</sub> is 100mV below the value of V<sub>OUT</sub> for V<sub>IN</sub> = V<sub>OUT</sub> + 0.5V.

2. Time needed for V<sub>OUT</sub> to reach 90% of final value.

## 7 Typical Operating Characteristics

$V_{IN} = V_{OUT} + 0.5V$ ,  $V_{OUT} = 2.85V$ ,  $C_{IN} = C_{OUT} = 1\mu F$ ,  $T_{AMB} = 25^{\circ}C$  (unless otherwise specified).

Figure 3. Output Voltage vs. Temperature

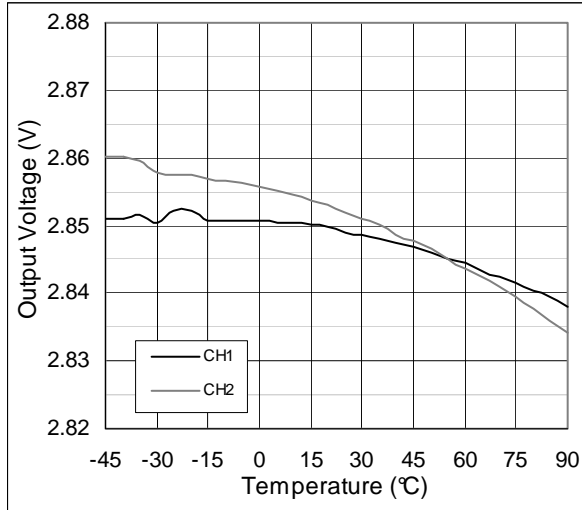

Figure 4. Output Voltage vs. Input Voltage

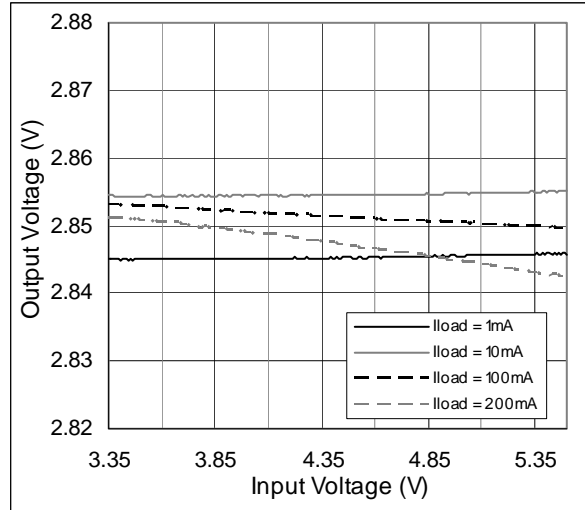

Figure 5. Output Voltage vs. Load Current

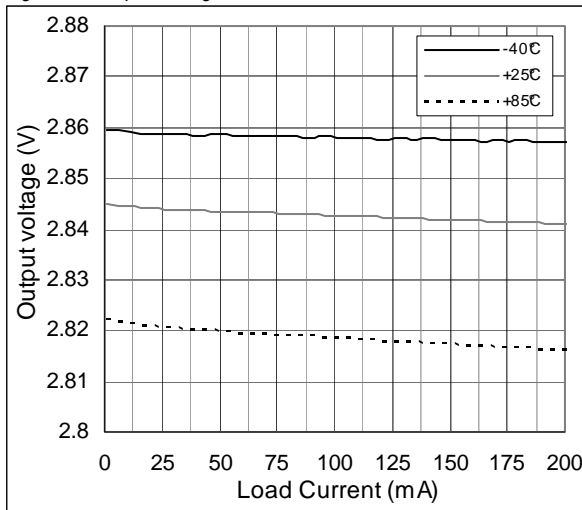

Figure 6. Output Voltage vs. Input Voltage - Dropout

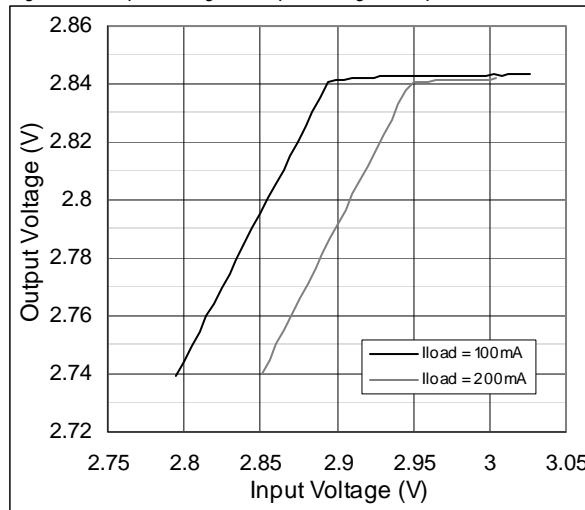

Figure 7. Dropout Voltage vs. Load Current

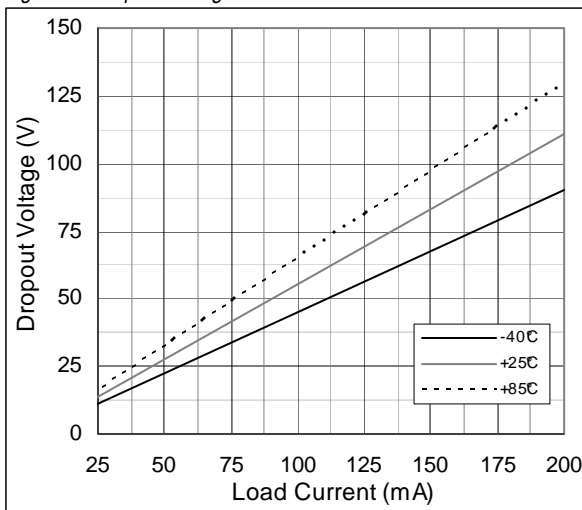

Figure 8. PSRR vs. Frequency

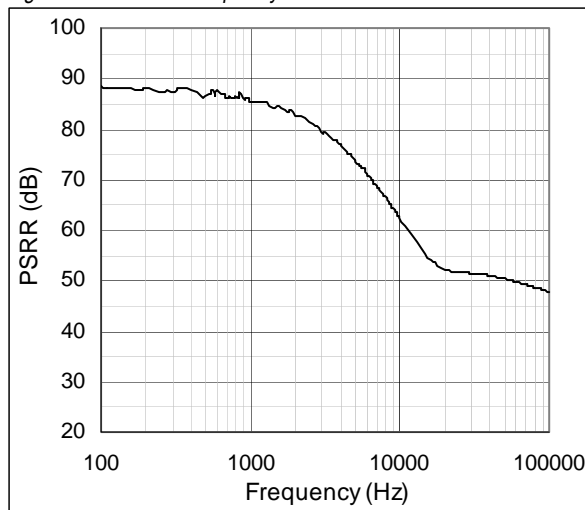

Figure 9. Ground Pin Current vs. Load Current

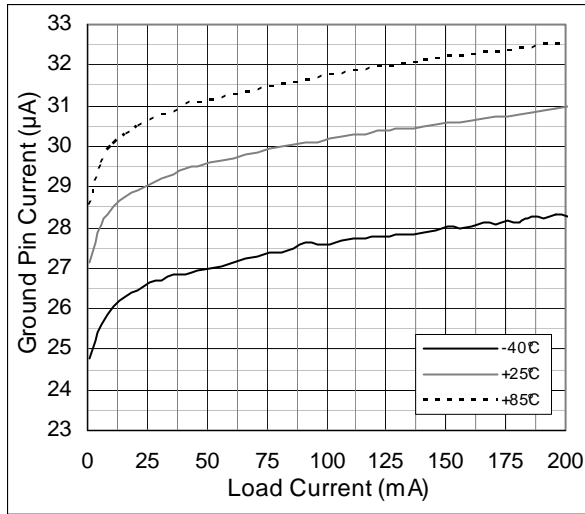

Figure 10. Ground Pin Current vs. Temperature

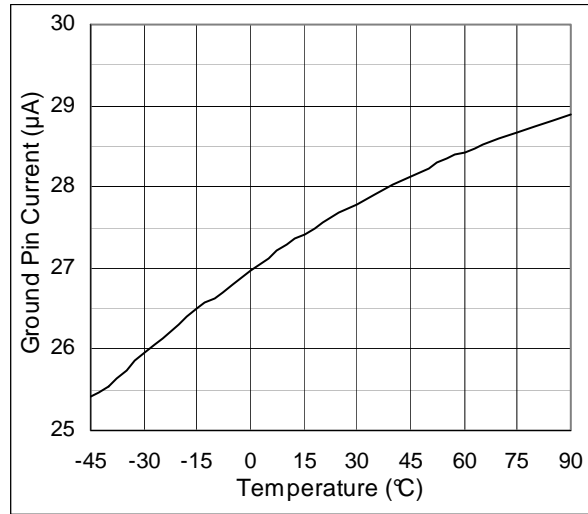

Figure 11. Ground Pin Current vs. Input Voltage; one Channel on, no Load

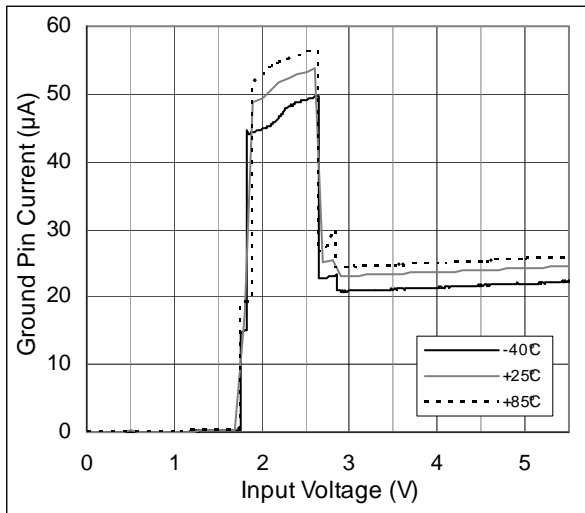

Figure 12. Ground Pin Current vs. Input Voltage; one Channel on, I<sub>LOAD</sub> = 200mA

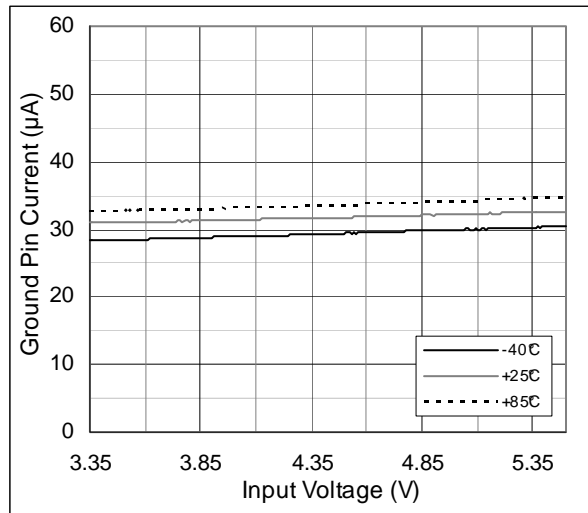

Figure 13. Ground Pin Current vs. Input Voltage; both Channels on, no Load

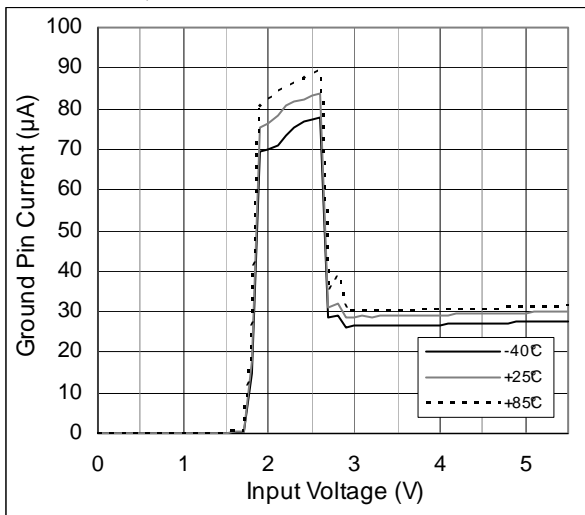

Figure 14. Ground Pin Current vs. Input Voltage; both Channels on, I<sub>LOAD</sub> = 200mA

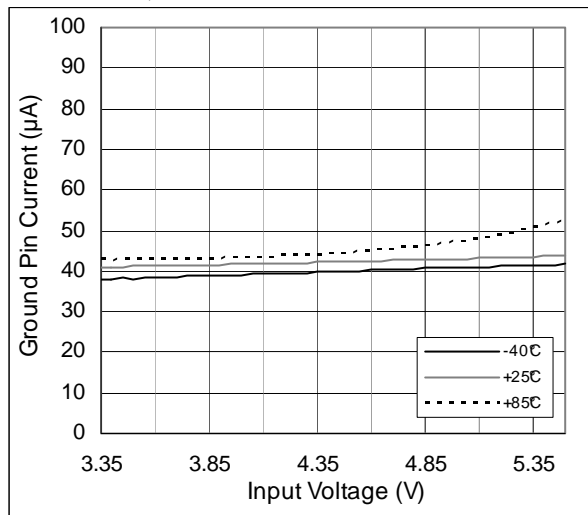

Figure 15. Shutdown Current vs. Input Voltage

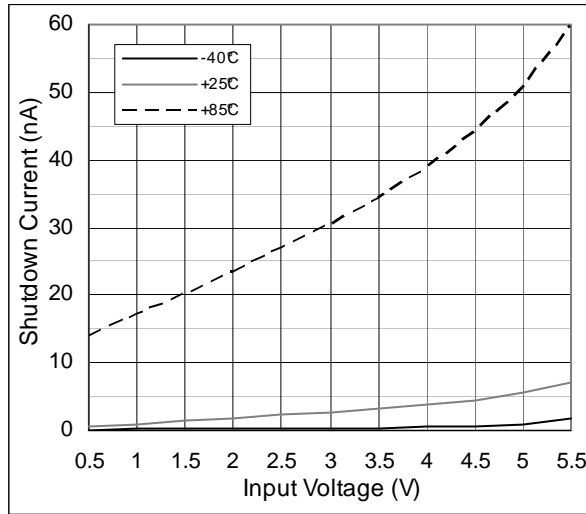

Figure 16. Load Regulation vs. Temperature

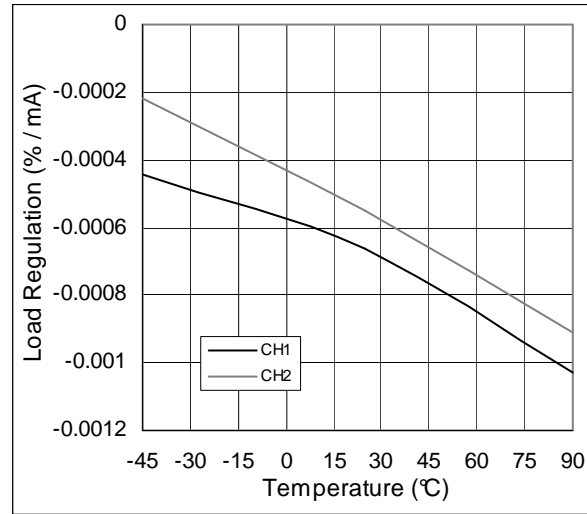

Figure 17. Line Regulation vs. Load Current

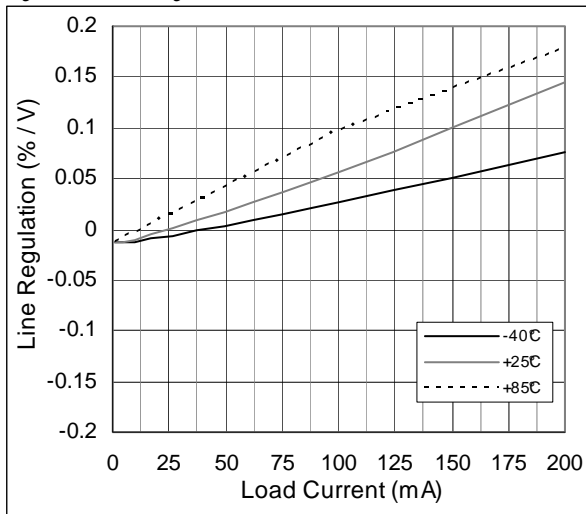

Figure 18. Line Regulation vs. Temperature

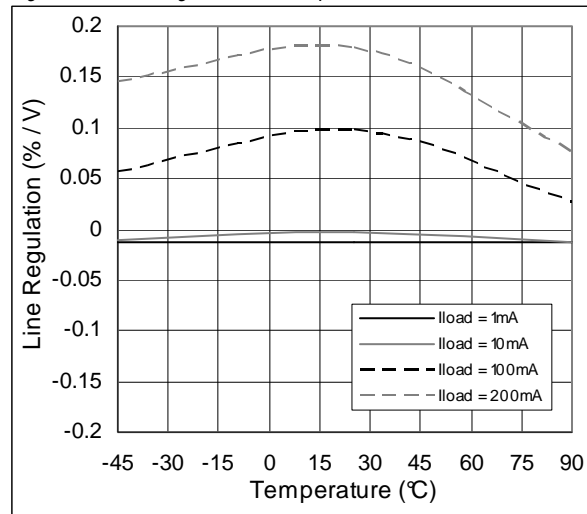

Figure 19. Load Transient Response, Crosstalk, between CH1 and CH2, I<sub>OUT</sub> = 200mA

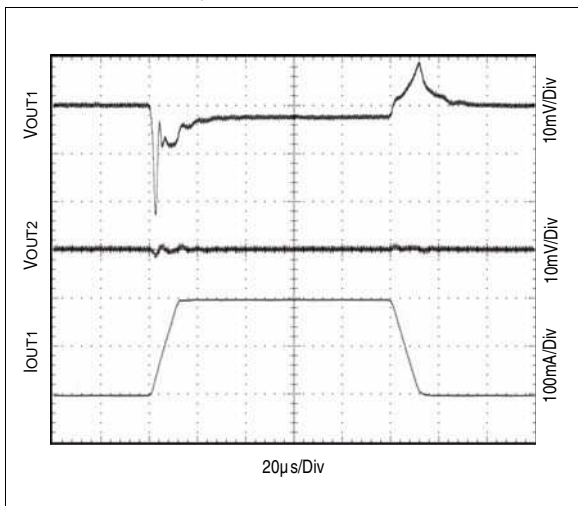

Figure 20. Load Transient Response near Dropout, I<sub>OUT</sub> = 200mA

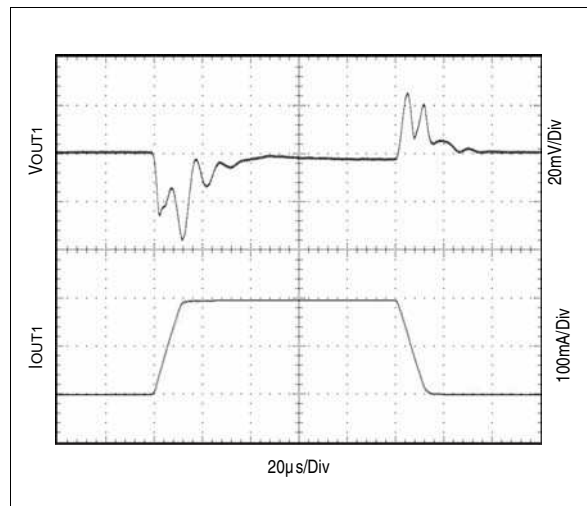

Figure 21. Line Transient Response

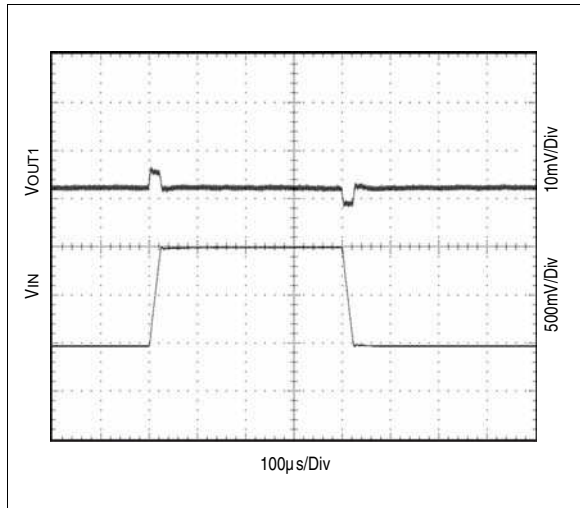

Figure 22. Shutdown

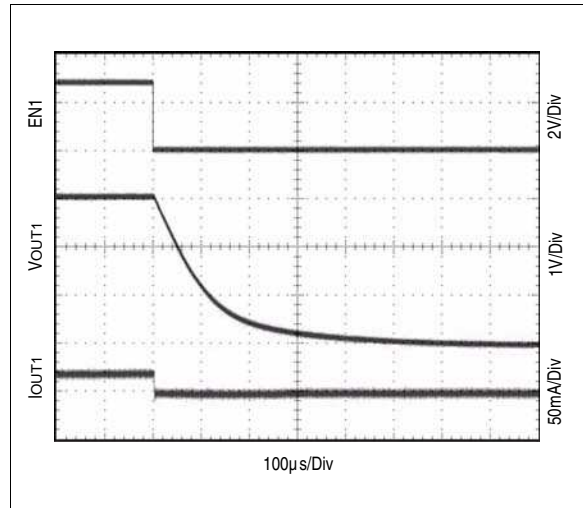

Figure 23. Startup of CH1 when CH2 is Off

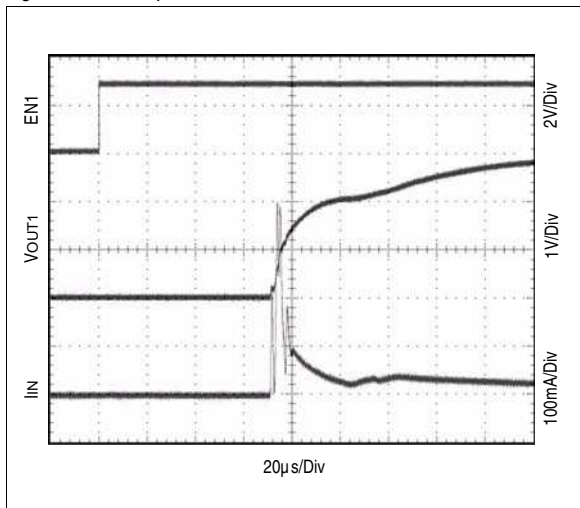
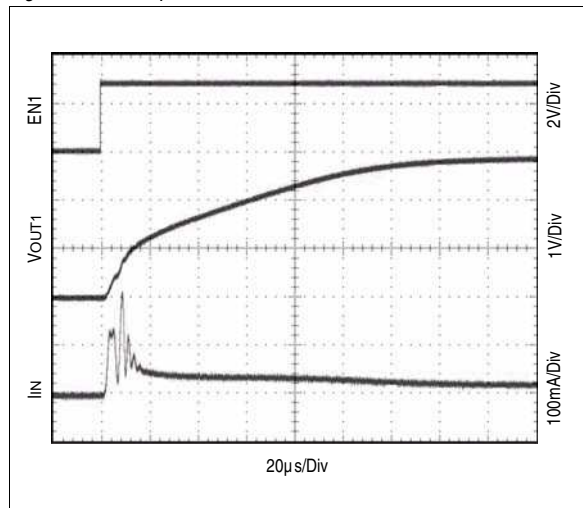

Figure 24. Startup of CH1 when CH2 is On





## 8 Detailed Description

Figure 25 shows the block diagram of the AS1374. It identifies the basics of a series linear regulator employing a P-Channel MOSFET as the control element. A stable voltage reference (REF in Figure 25) is compared with an attenuated sample of the output voltage. Any difference between the two voltages (reference and sample) creates an output from the error amplifier that drives the series control element to reduce the difference to a minimum. The error amplifier incorporates additional buffering to drive the relatively large gate capacitance of the series pass P-channel MOSFET, when additional drive current is required under transient conditions. Input supply variations are absorbed by the series element, and output voltage variations with loading are absorbed by the low output impedance of the regulator.

### 8.1 Output Voltage

The AS1374 deliver preset output voltages from 1.2V to 3.6V, in 50mV increments (see [Ordering Information on page 17](#)).

### 8.2 Enable

The AS1374 feature an active high enable mode to shutdown each output independently. Driving EN 1 low disables Output 1, driving EN 2 low disables Output 2. The disabled Output enters a high-impedance state.

Figure 25. AS1374 Block Diagram

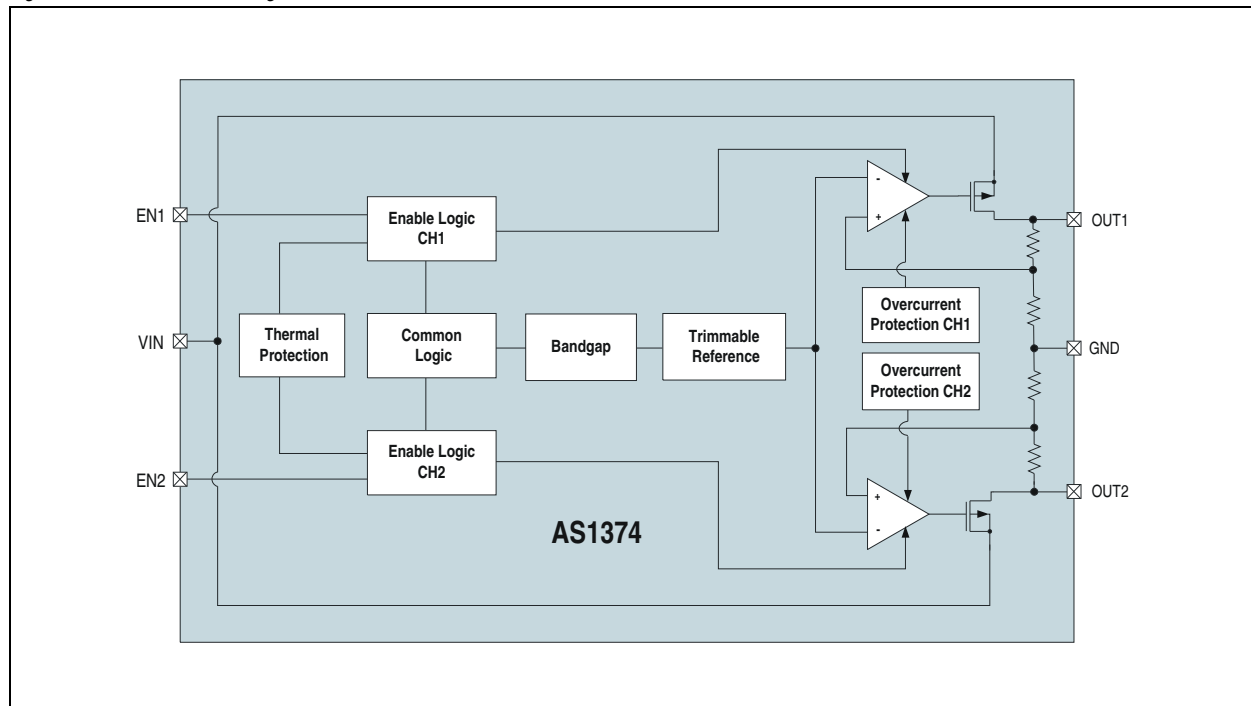

### 8.3 Current Limit

The AS1374 include a current limiting circuitry to monitor and control the P-channel MOSFET pass transistor's gate voltage, thus limiting the device output current to 300mA.

**Note:** See [Table 3 on page 4](#) for the recommended min and max current limits. The output can be shorted to ground indefinitely without causing damage to the device.

### 8.4 Thermal Protection

Integrated thermal protection circuitry limits total power dissipation in the AS1374. When the junction temperature ( $T_J$ ) exceeds  $+160^{\circ}\text{C}$ , the thermal sensor signals the shutdown logic, turning off the P-channel MOSFET pass transistor and allowing the device to cool down. The thermal sensor turns the pass transistor on again after the device's junction temperature drops by  $15^{\circ}\text{C}$ , resulting in a pulsed output during continuous thermal-overload conditions.

**Note:** Thermal protection is designed to protect the devices in the event of fault conditions. For continuous operation, do not exceed the absolute maximum junction temperature rating of  $+150^{\circ}\text{C}$ .

## 9 Application Information

### 9.1 Dropout Voltage

Dropout is the input to output voltage difference, below which the linear regulator ceases to regulate. At this point, the output voltage change follows the input voltage change. Dropout voltage may be measured at different load currents, but is usually specified at maximum output. As a result, the MOSFET maximum series resistance over temperature is obtained. More generally:

$$V_{DROPOUT} = I_{LOAD} \times R_{SERIES} \quad (EQ 1)$$

Dropout is probably the most important specification when the regulator is used in a battery application. The dropout performance of the regulator defines the useful “end of life” of the battery before replacement or re-charge is required.

Figure 26. Graphical Representation of Dropout Voltage

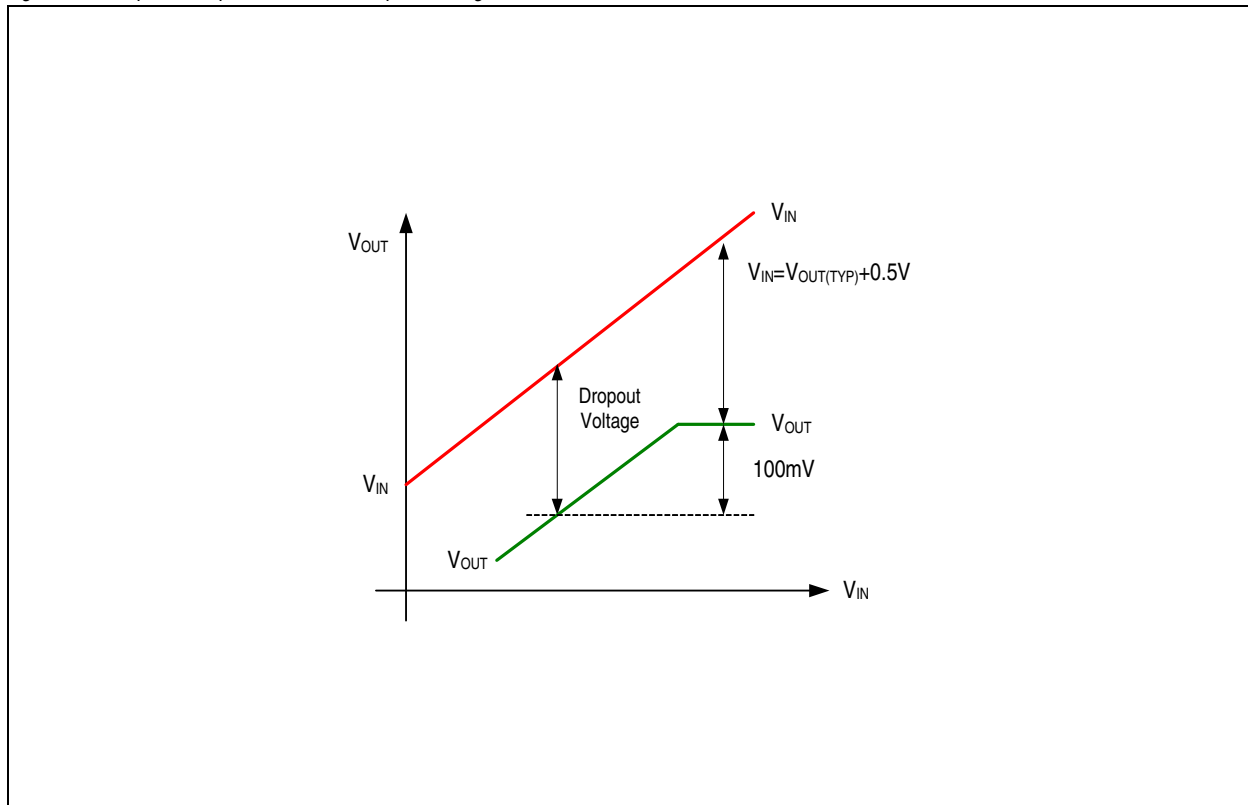

Figure 26 shows the variation of V<sub>OUT</sub> as V<sub>IN</sub> is varied for a certain load current. The practical value of dropout is the differential voltage (V<sub>OUT</sub> - V<sub>IN</sub>) measured at the point where the LDO output voltage has fallen by 100mV below the nominal, fully regulated output value. The nominal regulated output voltage of the LDO is that obtained when there is 500mV (or greater) input-output voltage differential.

### 9.2 Efficiency

Low quiescent current and low input-output voltage differential are important in battery applications amongst others, as the regulator efficiency is directly related to quiescent current and dropout voltage. Efficiency is given by:

$$Efficiency = \frac{V_{LOAD} \times I_{LOAD}}{V_{IN}(I_Q + I_{LOAD})} \times 100 \% \quad (EQ 2)$$

Where:

I<sub>Q</sub> = quiescent current of LDO

### 9.3 Power Dissipation

Maximum power dissipation (PD) of the LDO is the sum of the power dissipated by the internal series MOSFET and the quiescent current required to bias the internal voltage reference and the internal error amplifier, and is calculated as:

$$PD_{(MAX)}(Seriespass) = I_{LOAD(MAX)}(V_{IN(MAX)} - V_{OUT(MIN)}) \text{ Watts} \quad (EQ 3)$$

Internal power dissipation as a result of the bias current for the internal voltage reference and the error amplifier is calculated as:

$$PD_{(MAX)}(Bias) = V_{IN(MAX)}I_Q \text{ Watts} \quad (EQ 4)$$

Total LDO power dissipation is calculated as:

$$PD_{(MAX)}(Total) = PD_{(MAX)}(Seriespass) + PD_{(MAX)}(Bias) \text{ Watts} \quad (EQ 5)$$

### 9.4 Junction Temperature

Under all operating conditions, the maximum junction temperature should not be allowed to exceed 125°C (unless otherwise specified in the datasheet). Limiting the maximum junction temperature requires knowledge of the heat path from junction to case ( $\theta_{JC}$ °C/W fixed by the IC manufacturer), and adjustment of the case to ambient heat path ( $\theta_{CA}$ °C/W) by manipulation of the PCB copper area adjacent to the IC position.

Figure 27. Package Physical Arrangements

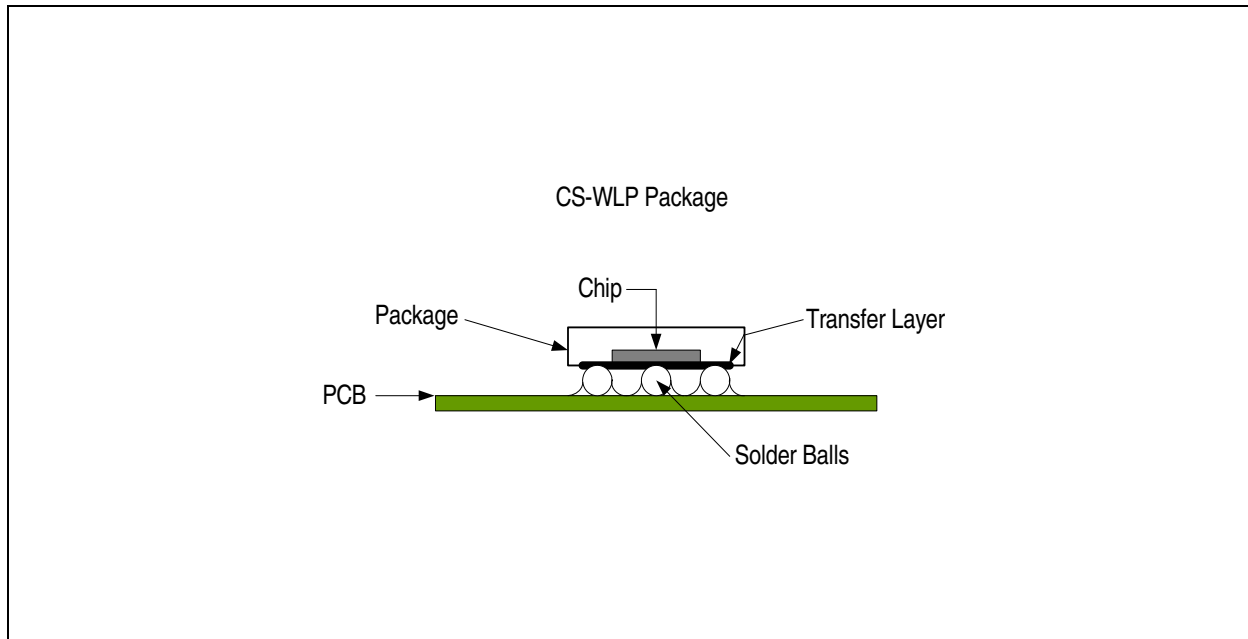
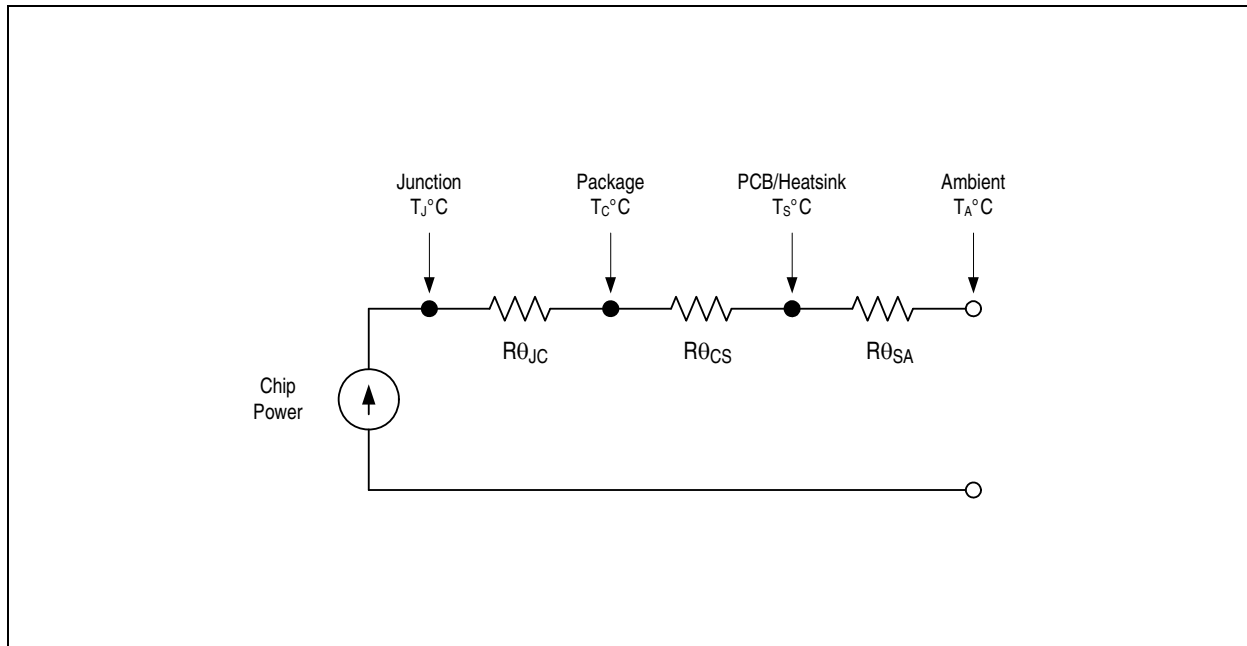

Figure 28. Steady State Heat Flow Equivalent Circuit



Total Thermal Path Resistance:

$$R\theta_{JA} = R\theta_{JC} + R\theta_{CS} + R\theta_{SA} \quad (\text{EQ 6})$$

Junction Temperature ( $T_J$  °C) is determined by:

$$T_J = (P_{D(\text{MAX})} \times R\theta_{JA}) + T_{\text{AMB}} \text{ °C} \quad (\text{EQ 7})$$

## 9.5 Explanation of Steady State Specifications

### 9.5.1 Line Regulation

Line regulation is defined as the change in output voltage when the input (or line) voltage is changed by a known quantity. It is a measure of the regulator's ability to maintain a constant output voltage when the input voltage changes. Line regulation is a measure of the DC open loop gain of the error amplifier. More generally:

$$\text{Line Regulation} = \frac{\Delta V_{OUT}}{\Delta V_{IN}} \text{ and is a pure number} \quad (\text{EQ 8})$$

In practise, line regulation is referred to the regulator output voltage in terms of % /  $V_{OUT}$ . This is particularly useful when the same regulator is available with numerous output voltage trim options.

$$\text{Line Regulation} = \frac{\Delta V_{OUT}}{\Delta V_{IN}} \times \frac{100}{V_{OUT}} \% / V \quad (\text{EQ 9})$$

### 9.5.2 Load Regulation

Load regulation is defined as the change of the output voltage when the load current is changed by a known quantity. It is a measure of the regulator's ability to maintain a constant output voltage when the load changes. Load regulation is a measure of the DC closed loop output resistance of the regulator. More generally:

$$\text{Load Regulation} = \frac{\Delta V_{OUT}}{\Delta I_{OUT}} \text{ and is units of ohms } (\Omega) \quad (\text{EQ 10})$$

In practise, load regulation is referred to the regulator output voltage in terms of % / mA. This is particularly useful when the same regulator is available with numerous output voltage trim options.

$$\text{Load Regulation} = \frac{\Delta V_{OUT}}{\Delta I_{OUT}} \times \frac{100}{V_{OUT}} \% / \text{mA} \quad (\text{EQ 11})$$

### 9.5.3 Setting Accuracy

Accuracy of the final output voltage is determined by the accuracy of the ratio of R1 and R2, the reference accuracy and the input offset voltage of the error amplifier. When the regulator is supplied pre-trimmed, the output voltage accuracy is fully defined in the output voltage specification.

When the regulator has a SET terminal, the output voltage may be adjusted externally. In this case, the tolerance of the external resistor network must be incorporated into the final accuracy calculation. Generally:

$$V_{OUT} = (V_{SET} \pm \Delta V_{SET}) \left( 1 + \frac{R1 \pm \Delta R1}{R2 \pm \Delta R2} \right) \quad (EQ 12)$$

The reference tolerance is given both at 25°C and over the full operating temperature range.

### 9.5.4 Total Accuracy

Away from dropout, total steady state accuracy is the sum of setting accuracy, load regulation and line regulation. Generally:

$$\text{Total \% Accuracy} = \text{Setting \% Accuracy} + \text{Load Regulation \%} + \text{Line Regulation \%} \quad (EQ 13)$$

## 9.6 Explanation of Dynamic Specifications

### 9.6.1 Power Supply Rejection Ratio (PSRR)

Known also as Ripple Rejection, this specification measures the ability of the regulator to reject noise and ripple beyond DC. PSRR is a summation of the individual rejections of the error amplifier, reference and AC leakage through the series pass transistor. The specification, in the form of a typical attenuation plot with respect to frequency, shows up the gain bandwidth compromises forced upon the designer in low quiescent current conditions. Generally:

$$PSRR = 20 \text{Log} \frac{\delta V_{OUT}}{\delta V_{IN}} \text{ dB using lower case } \delta \text{ to indicate AC values} \quad (EQ 14)$$

Power supply rejection ratio is fixed by the internal design of the regulator. Additional rejection must be provided externally. The AS1374 is designed to deliver low noise and high PSRR, with low quiescent currents in battery-powered systems. The power-supply rejection is 85dB at 1kHz and 50dB at 100kHz. When operating from sources other than batteries, improved supply-noise rejection and transient response are achieved by increasing the values of the input and output capacitors. Additional passive LC filtering at the input can provide enhanced rejection at high frequencies.

### 9.6.2 Output Capacitor ESR

The series regulator is a negative feedback amplifier, and as such is conditionally stable. The ESR of the output capacitor is usually used to cancel one of the open loop poles of the error amplifier in order to produce a single pole response. Excessive ESR values may actually cause instability by excessive changes to the closed loop unity gain frequency crossover point. The range of ESR values for stability is usually shown either by a plot of stable ESR versus load current, or a maximum value in the datasheet.

Some ceramic capacitors exhibit large capacitance and ESR variations with variations in temperature. Z5U and Y5V capacitors may be required to ensure stability at temperatures below  $T_{AMB} = -10^{\circ}\text{C}$ . With X7R or X5R capacitors, a 1μF capacitor should be sufficient at all operating temperatures.

Larger output capacitor values (10μF) help to reduce noise and improve load transient-response, stability and power-supply rejection.

### 9.6.3 Input Capacitor

An input capacitor at  $V_{IN}$  is required for stability. It is recommended that a 1.0μF capacitor be connected between the AS1369 power supply input pin  $V_{IN}$  and ground (capacitance value may be increased without limit subject to ESR limits). This capacitor must be located at a distance of not more than 1cm from the  $V_{IN}$  pin and returned to a clean analog ground. Any good quality ceramic, tantalum, or film capacitor may be used at the input.

### 9.6.4 Noise

The regulator output is a DC voltage with noise superimposed on the output. The noise comes from three sources; the reference, the error amplifier input stage, and the output voltage setting resistors. Noise is a random fluctuation and if not minimized in some applications, will produce system problems.

### 9.6.5 Transient Response

The series regulator is a negative feedback system, and therefore any change at the output will take a finite time to be corrected by the error loop. This “propagation time” is related to the bandwidth of the error loop. The initial response to an output transient comes from the output capacitance, and during this time, ESR is the dominant mechanism causing voltage transients at the output. More generally:

$$\delta V_{TRANSIENT} = \delta I_{OUTPUT} \times R_{ESR} \quad \text{Units are Volts, Amps, Ohms.} \quad (EQ 15)$$

Thus an initial +50mA change of output current will produce a -12mV transient when the ESR=240mΩ. Do remember to keep the ESR within stability recommendations when reducing ESR by adding multiple parallel output capacitors.

After the initial ESR transient, there follows a voltage droop during the time that the LDO feedback loop takes to respond to the output change. This drift is approx. linear in time and sums with the ESR contribution to make a total transient variation at the output of:

$$\delta V_{TRANSIENT} = \delta I_{OUTPUT} \times \left( R_{ESR} + \frac{T}{C_{LOAD}} \right) \quad \text{Units are Volts, Seconds, Farads, Ohms.} \quad (EQ 16)$$

Where:

C<sub>LOAD</sub> is output capacitor

T= Propagation Delay of the LDO

This shows why it is convenient to increase the output capacitor value for a better support for fast load changes. Of course the formula holds for  $t < \text{“propagation time”}$ , so that a faster LDO needs a smaller cap at the load to achieve a similar transient response. For instance 50mA load current step produces 50mV output drop if the LDO response is 1μsec and the load cap is 1μF.

There is also a steady state error caused by the finite output impedance of the regulator. This is derived from the load regulation specification discussed above.

### 9.6.6 Turn On Time

This specification defines the time taken for the LDO to awake from shutdown. The time is measured from the release of the enable pin to the time that the output voltage is within 5% of the final value. It assumes that the voltage at V<sub>IN</sub> is stable and within the regulator min and max limits. Shutdown reduces the quiescent current to very low, mostly leakage values (<1μA).

### 9.6.7 Thermal Protection

To prevent operation under extreme fault conditions, such as a permanent short circuit at the output, thermal protection is built into the device. Die temperature is measured, and when a 160°C threshold is reached, the device enters shutdown. When the die cools sufficiently, the device will restart (assuming input voltage exists and the device is enabled). Hysteresis of 15°C prevents low frequency oscillation between start-up and shutdown around the temperature threshold.

# 10 Package Drawings and Markings

The AS1374 is available in a 6-bump WLP package.

Figure 29. 6-bump WLP Package

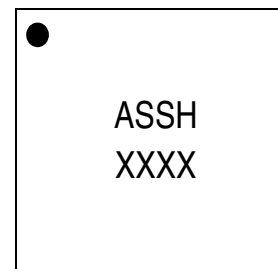
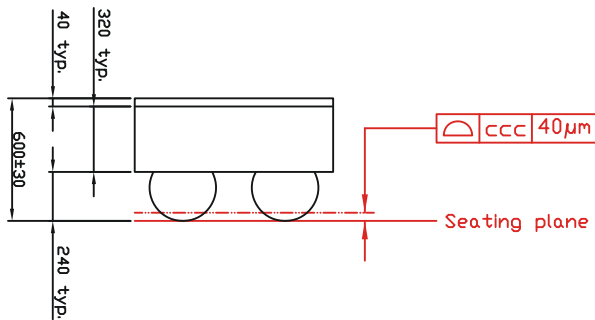
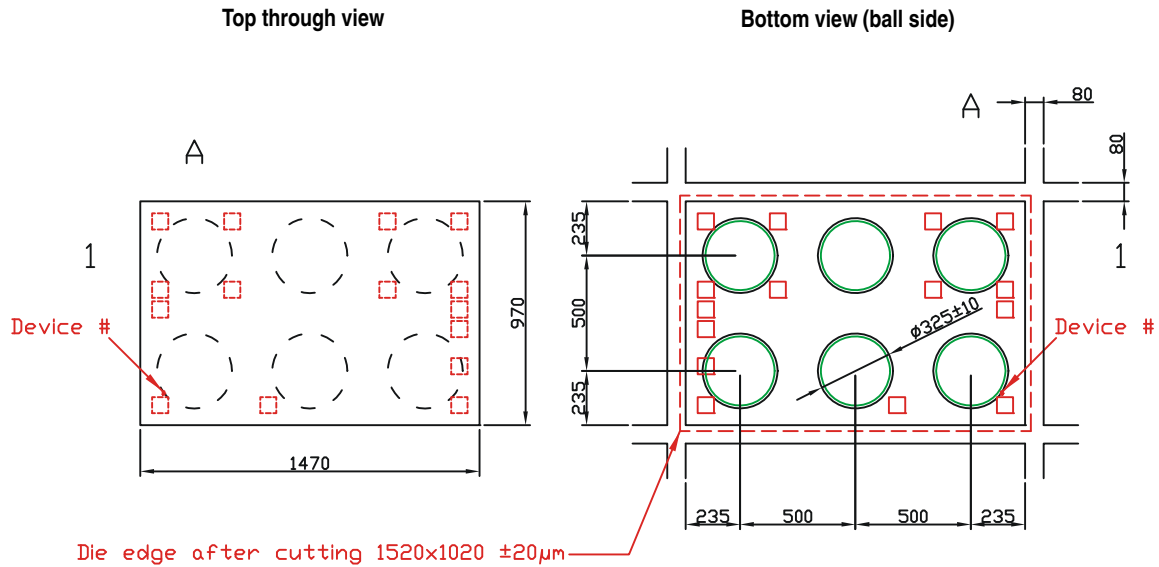

**Notes:**

1. ccc – Coplanarity
2. All dimensions are in μm.



## Revision History

Revision	Date	Owner	Description
			Initial revisions
1.7	11 Oct, 2011	afe	Changes made across the document
1.8	12 Dec, 2011		Updated equations in <a href="#">Power Dissipation</a> section

**Note:** Typos may not be explicitly mentioned under revision history.



## 11 Ordering Information

The devices are available as the standard products shown in [Table 4](#).

Table 4. Ordering Information

Ordering Code	Marking	Output Voltage 1	Output Voltage 2	Delivery Form	Package
AS1374-BWLT-285	ASSH	2.85V	2.85V	Tape and Reel	6-bump WLP
AS1374-BWLT1833	ASSJ	1.8V	3.3V	Tape and Reel	6-bump WLP
AS1374-BWLT1818	ASSP	1.8V	1.8V	Tape and Reel	6-bump WLP
AS1374-BWLT1218	ASSK	1.2V	1.8V	Tape and Reel	6-bump WLP
AS1374-BWLT1214	ASSY	1.2V	1.4V	Tape and Reel	6-bump WLP
AS1374-BWLT18285	ASSZ	1.8V	2.85V	Tape and Reel	6-bump WLP
AS1374-BWLT1212	ASSW	1.2V	1.2V	Tape and Reel	6-bump WLP
AS1374-BWLT1827	ASTB	1.8V	2.7V	Tape and Reel	6-bump WLP
AS1374-BWLT1533 <sup>1</sup>	ASTF	1.5V	3.3V	Tape and Reel	6-bump WLP
AS1374-BWLT1820 <sup>1</sup>	ASTG	1.8V	2.0V	Tape and Reel	6-bump WLP
AS1374-BWLT1821 <sup>1</sup>	ASTH	1.8V	2.1V	Tape and Reel	6-bump WLP
AS1374-BWLT2533 <sup>1</sup>	ASTI	2.5V	3.3V	Tape and Reel	6-bump WLP
AS1374-BWLT <sup>2</sup>	—	tbd	tbd	Tape and Reel	6-bump WLP

1. On request

2. Non-standard devices from 1.2V to 3.6V are available in 50mV steps.

For more information and inquiries contact <http://www.austriamicrosystems.com/contact>

**Note:** All products are RoHS compliant and austriamicrosystems green.

Buy our products or get free samples online at ICdirect: <http://www.austriamicrosystems.com/ICdirect>

Technical Support is available at <http://www.austriamicrosystems.com/Technical-Support>

For further information and requests, please contact us <mailto:sales@austriamicrosystems.com>  
or find your local distributor at <http://www.austriamicrosystems.com/distributor>

## Copyrights

Copyright © 1997-2011, austriamicrosystems AG, Tobelbaderstrasse 30, 8141 Unterpremstaetten, Austria-Europe. Trademarks Registered ®. All rights reserved. The material herein may not be reproduced, adapted, merged, translated, stored, or used without the prior written consent of the copyright owner.

All products and companies mentioned are trademarks or registered trademarks of their respective companies.

## Disclaimer

Devices sold by austriamicrosystems AG are covered by the warranty and patent indemnification provisions appearing in its Term of Sale. austriamicrosystems AG makes no warranty, express, statutory, implied, or by description regarding the information set forth herein or regarding the freedom of the described devices from patent infringement. austriamicrosystems AG reserves the right to change specifications and prices at any time and without notice. Therefore, prior to designing this product into a system, it is necessary to check with austriamicrosystems AG for current information. This product is intended for use in normal commercial applications. Applications requiring extended temperature range, unusual environmental requirements, or high reliability applications, such as military, medical life-support or life-sustaining equipment are specifically not recommended without additional processing by austriamicrosystems AG for each application. For shipments of less than 100 parts the manufacturing flow might show deviations from the standard production flow, such as test flow or test location.

The information furnished here by austriamicrosystems AG is believed to be correct and accurate. However, austriamicrosystems AG shall not be liable to recipient or any third party for any damages, including but not limited to personal injury, property damage, loss of profits, loss of use, interruption of business or indirect, special, incidental or consequential damages, of any kind, in connection with or arising out of the furnishing, performance or use of the technical data herein. No obligation or liability to recipient or any third party shall arise or flow out of austriamicrosystems AG rendering of technical or other services.



## Contact Information

### Headquarters

austriamicrosystems AG  
Tobelbaderstrasse 30  
A-8141 Unterpremstaetten, Austria

Tel: +43 (0) 3136 500 0  
Fax: +43 (0) 3136 525 01

For Sales Offices, Distributors and Representatives, please visit:  
<http://www.austriamicrosystems.com/contact>