

Optimal IV[®] Star Series

Mono-Color, Multi-LED Recessed Die Design (RDD)



OV4Zxxxx

- Designed for 4 1-watt chips in recessed cavity with an optical grade 5mm diameter lens
- Exceptional thermal resistance (1.8°C/W junction to heatsink)
- Solder Pads Au Plated
- Locating slots for M3 screws

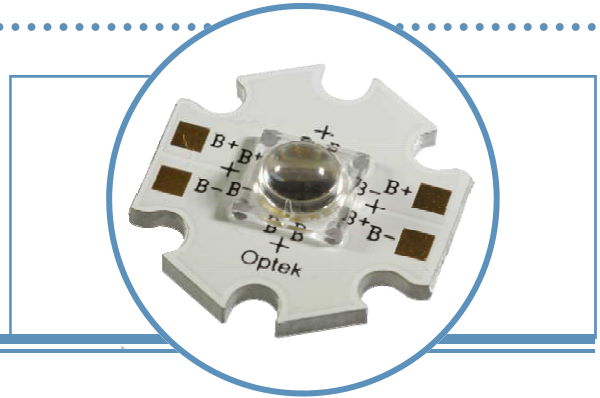

Part Number	Color	Material	Beam Angle	Typ. Dominant Wavelength (nm)	Typical Luminous Flux (lm)		Typical Forward Voltage (V _F)	
					350 mA	700mA	350 mA	700mA
OV4ZAAAA	Amber	AllnGaP	60°	590	109	170	8.6	9.35
OV4ZBBBB	Blue	InGaN		458	29	49	12.6	14.2
OV4ZGGGG	Green	InGaN		532	173	272	13.1	14.6
OV4ZRRRR	Red	AllnGaP		625	102	183	8.7	9.55

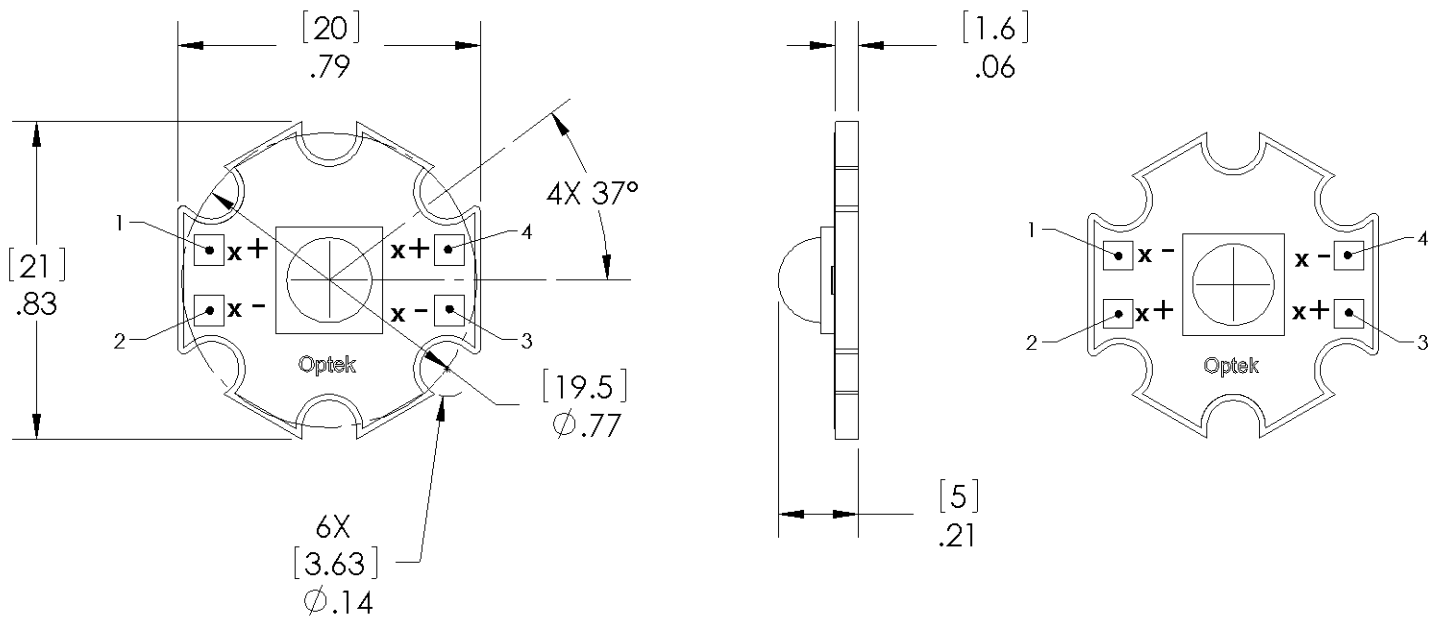

BLUE OR GREEN	
PIN #	DESIGNATOR
1, 4	ANODE
2, 3	CATHODE

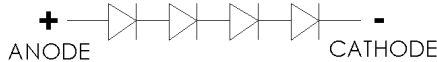

AMBER OR RED	
PIN #	DESIGNATOR
1, 4	CATHODE
2, 3	ANODE

Notes:

- Test conditions: I_F=350 mA / 700 mA; T_J @ 25°C
- Polarity Pads opposite for Red / Amber vs. Blue / Green
- All dimensions are in inches & [millimeters].
- Additional heat sinking required.



DO NOT LOOK DIRECTLY AT LED WITH UNSHIELDED EYES OR DAMAGE TO RETINA MAY OCCUR.

OPTEK reserves the right to make changes at any time in order to improve design and to supply the best product possible.

Absolute Maximum Ratings

DC Forward Current /die	700 mA
Peak Pulsed Forward Current ¹	6.0 A
Reverse Voltage	5 V
Maximum Allowable Junction Temperature ²	130°C
Storage and Operating Temperature	-50° ~ +100 °C
Electrostatic Discharge Classification (JEDEC-JESD22-A114F)	Class 1C

Notes:

1. Pulse width 1 ms maximum. Duty cycle 1/16.
2. Thermal Resistance junction to Board (T_{jhs}) is <2°C/W

Electrical Characteristics (I_F = 350 mA , T_J = 25°C)

SYMBOL	PARAMETER	TYP	MAX	UNITS
V _F	Forward Voltage (Amber)	8.6	10.0	V
	Forward Voltage (Blue)	12.6	13.7	V
	Forward Voltage (Green)	13.1	14.1	V
	Forward Voltage (Red)	8.7	10.1	V
	V _F -Temperature Co-efficient (Amber & Red)	-6.42	----	mV/°C
	V _F -Temperature Co-efficient (Blue)	-4.81	----	mV/°C
	V _F -Temperature Co-efficient (Green)	-4.95	----	mV/°C

Optical Characteristics (I_F = 350 mA, T_J = 25°C)

COLOR	LUMINOUS FLUX (lm) @ I _F = 350mA		DOMINANT WAVELENGTH			SPECTRAL HALF WIDTH	DOMINANT WAVELENGTH TEMPERATURE COEFFICIENT
	MIN	TYP	MIN	TYP	MAX		
Amber	55	109	585	590	595	16 nm	0.07 nm/°C
Blue	20	29	455	458	460	20 nm	0.04 nm/°C
Green	110	173	530	532	535	40 nm	0.04 nm/°C
Red	65	102	620	625	630	37 nm	0.05 nm/°C

Packaging: 10 Optimal IV[®] stars per tube

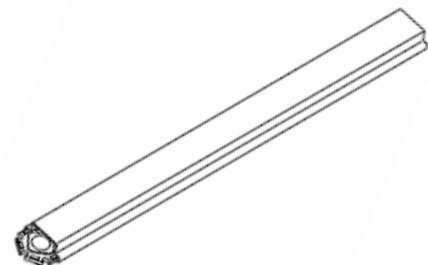
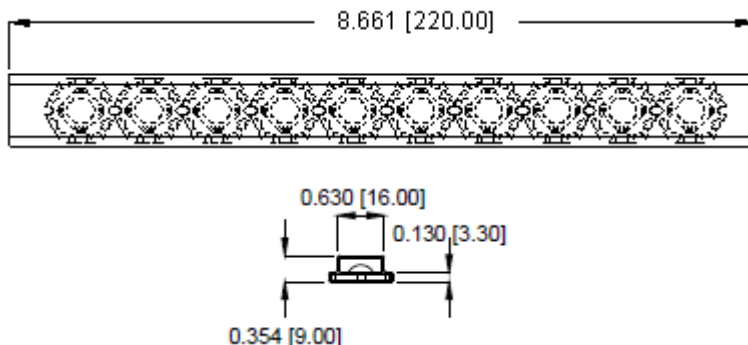

OPTEK reserves the right to make changes at any time in order to improve design and to supply the best product possible.

Relative Spectral Responses

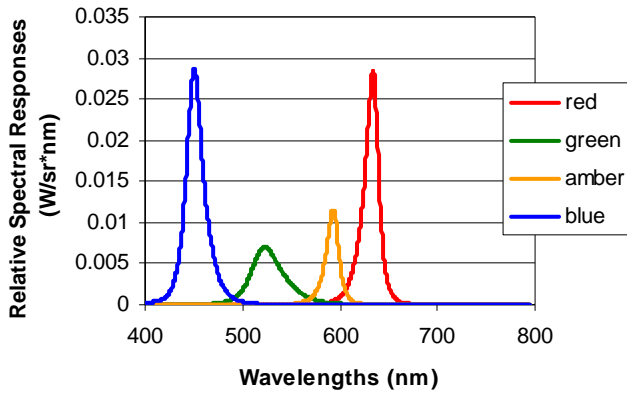

Dominant Wavelength vs IF

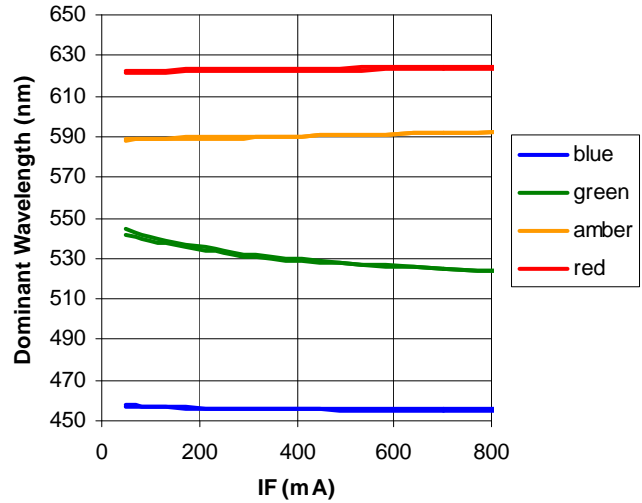

IF vs VF

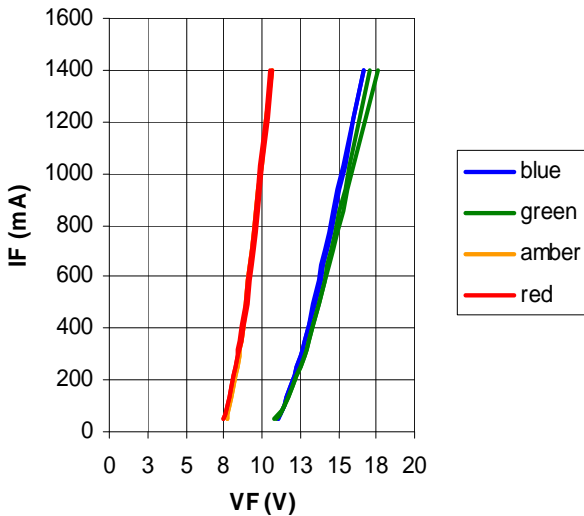

Total Luminous Flux vs IF

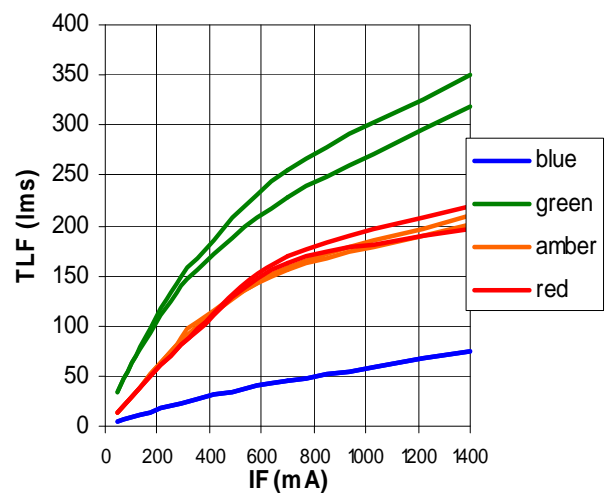

Duty Ratio vs. Allowable Forward Current
T = 1 ms & variable PW

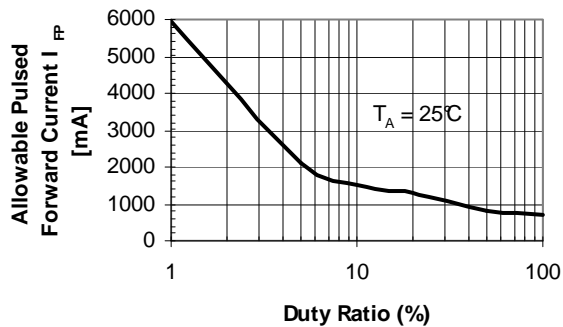

Derating Curve

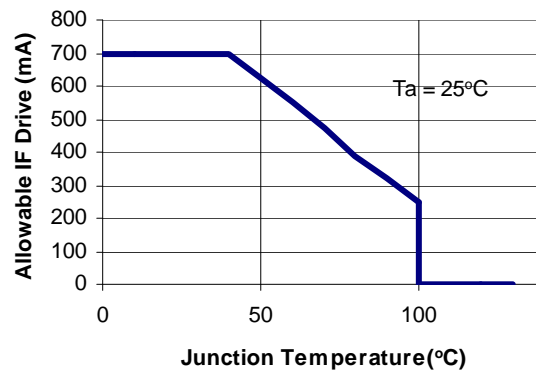

OPTEK reserves the right to make changes at any time in order to improve design and to supply the best product possible.