

TRIAC(Through Hole / Isolated)

TMG25C60J

SanRex Triac TMG25C60J is designed for full wave AC control applications. It can be used as an ON/OFF function or for phase control operation.

Typical Applications

- Home Appliances : Washing Machines, Vacuum Cleaners, Rice Cookers, Micro Wave Ovens, Hair Dryers, other control applications
- Industrial Use : SMPS, Copier Machines, Motor Controls, Dimmer, SSR, Heater Controls, Vending Machines, other control applications

Features

- $I_{T(RMS)}=25A$
- High Surge Current
- Low Voltage Drop
- Lead-Free Package

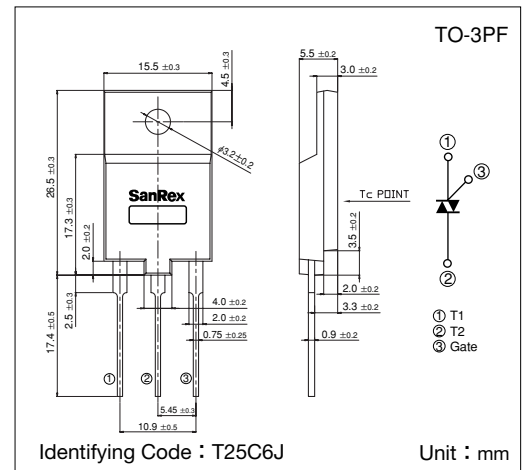

Maximum Ratings

($T_j=25^\circ C$ unless otherwise specified)

Symbol	Item	Reference	Ratings	Unit
V_{DRM}	Repetitive Peak Off-State Voltage		600	V
$I_{T(RMS)}$	R.M.S. On-State Current	$T_c=83^\circ C$	25	A
I_{TSM}	Surge On-State Current	One cycle, 50Hz/60Hz, Peak value non-repetitive	225/250	A
I^2t	I^2t (for fusing)		260	A^2S
PGM	Peak Gate Power Dissipation		5	W
$P_{G(AV)}$	Average Gate Power Dissipation		0.5	W
I_{GM}	Peak Gate Current		2	A
V_{GM}	Peak Gate Voltage		10	V
V_{ISO}	Isolation Breakdown Voltage (R.M.S.)	A.C. 1minute	1500	V
T_j	Operating Junction Temperature		$-40 \sim +125$	$^\circ C$
T_{stg}	Storage Temperature		$-40 \sim +150$	$^\circ C$
	Mass		5.6	g

Electrical Characteristics

Symbol	Item	Reference	Ratings			Unit	
			Min.	Typ.	Max.		
I_{DRM}	Repetitive Peak Off-State Current	$V_D=V_{DRM}$, Single phase, half wave, $T_j=125^\circ C$			5	mA	
V_{TM}	Peak On-State Voltage	$I_T=35A$, Inst. measurement			1.4	V	
I_{GT1}^+	Gate Trigger Current	$V_D=6V$, $R_L=10\Omega$			30	mA	
I_{GT1}^-					30		
I_{GT3}^+					—		
I_{GT3}^-					30		
V_{GT1}^+	Gate Trigger Voltage					1.5	V
V_{GT1}^-						1.5	
V_{GT3}^+						—	
V_{GT3}^-						1.5	
V_{GD}	Non-Trigger Gate Voltage	$T_j=125^\circ C$, $V_D=1/2 V_{DRM}$	0.2			V	
$(dv/dt)_c$	Critical Rate of Rise of Off-State Voltage at Commutation	$T_j=125^\circ C$, $(di/dt)_c=-12.5A/ms$, $V_D=2/3 V_{DRM}$	10			$V/\mu s$	
I_H	Holding Current			35		mA	
R_{th}	Thermal Resistance	Junction to case			1.4	$^\circ C/W$	

Trigger mode of the triac

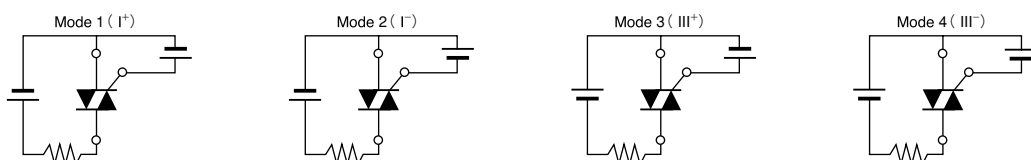

Gate Characteristics

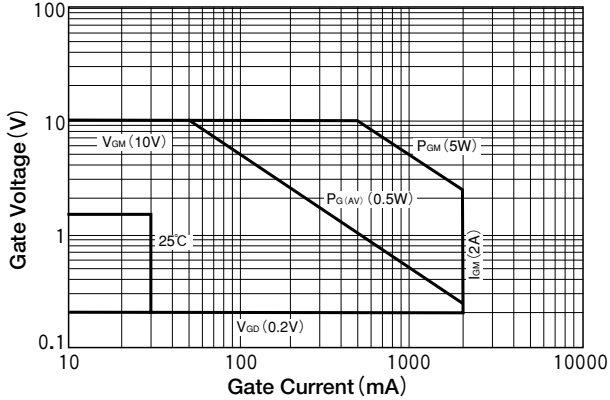

On-State Characteristics (MAX)

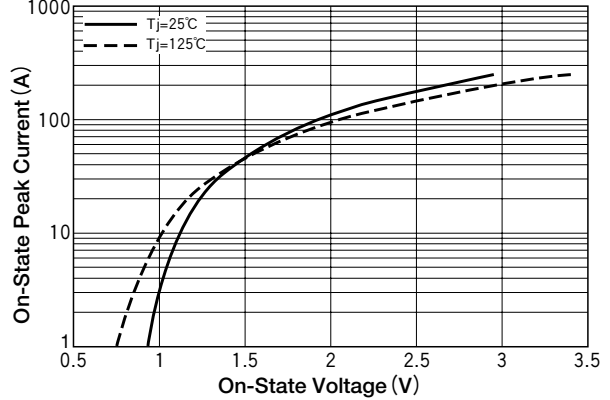

RMS On-State Current vs Maximum Power Dissipation

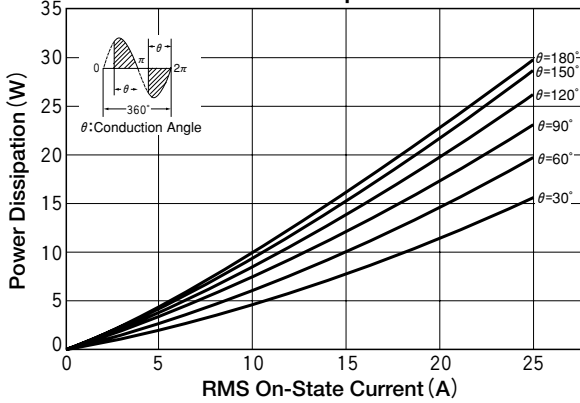

RMS On-State vs Allowable Case Temperature

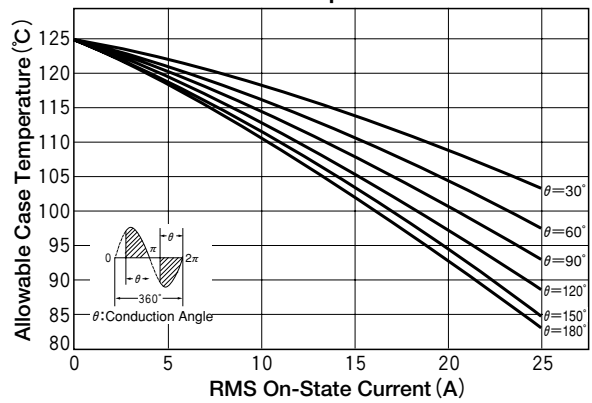

Surge On-State Current Rating (Non-Repetitive)

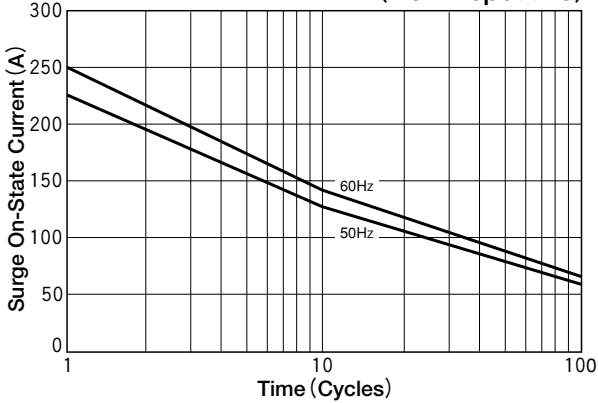

Transient Thermal Impedance

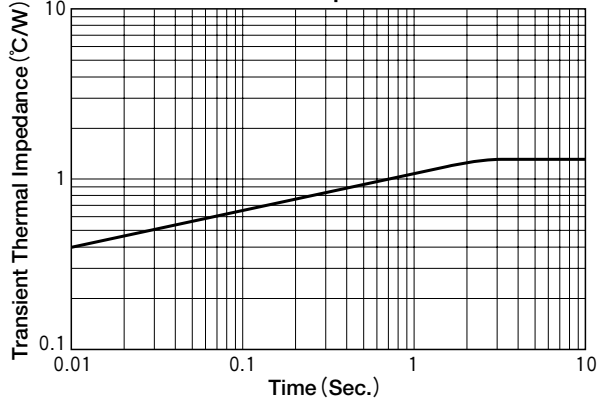

I_{GT} - T_j (Typical)

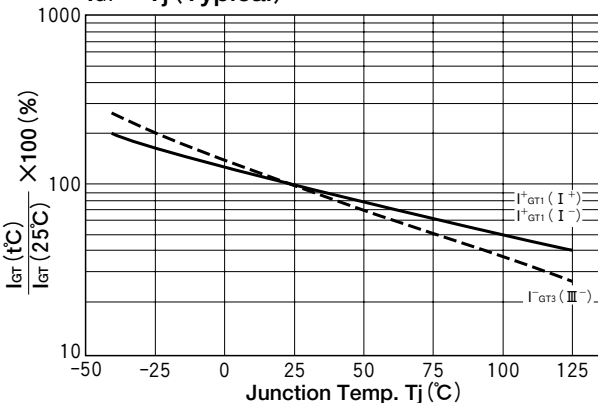

V_{GT} - T_j (Typical)

