

Part Nos. WMG60M, WMG60B

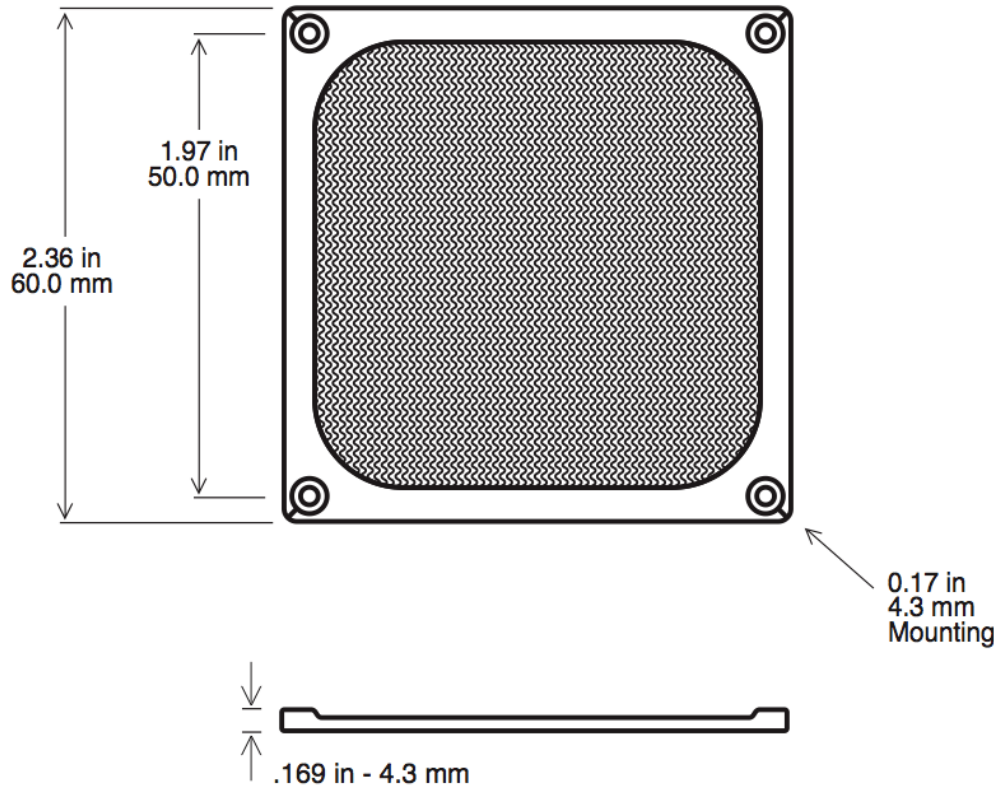

Wire Mesh Guard for 60mm Fan



Aluminum/Stainless filters offer high levels of air passage while efficiently filtering contaminants and shielding EMI/RFI.

Tightly woven stainless corrugated mesh screen
(30x30, 3/16" Pitch, 1/8" Deep)

Filters may be mounted directly onto the fan or to any other housing.

Finishes:
Mill - Natural Aluminum
(suffix "M")



Black Anodized
(suffix "B")



Part No.	Description
WMG60M	Aluminum Fan Filter, mill finish
WMG60B	Aluminum Fan Filter, black finish
WMG60M/PK	10-pack mill finish Aluminum filter, boxed
WMG60B/PK	10-pack black Aluminum filter, boxed