

Product Summary

- $V_R = 40V$
- $I_C = 2A$

Description and Applications

A surface mount Schottky Barrier Diode featuring low forward voltage drop suitable for high frequency rectification and reverse voltage protection.

- Mobile Telecomms
- DC – DC Converters
- High Frequency Rectification

Features and Benefits

- High current capability
- Low Forward Voltage
- Fast Recovery Time
- Small Package Size
- **Qualified to AEC-Q101 Standards for High Reliability**

Mechanical Data

- Case: SOT26
- Case Material: Molded Plastic, "Green" Molding Compound. UL Flammability Classification Rating 94V-0
- Moisture Sensitivity: Level 1 per J-STD-020
- Terminals: Matte Tin Finish annealed over Copper leadframe (Lead Free Plating) Solderable per MIL-STD-202, Method 208
- Weight: 0.016 grams (approximate)

SOT26



Top View

Device Symbol

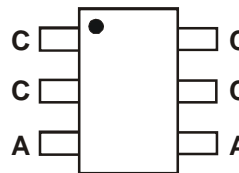

Top View
Pin Out

Ordering Information (Note 1)

Device	Packaging	Shipping
ZHCS2000TA	SOT26	3000/Tape & Reel

Notes: 1. For Packaging Details, go to our website at <http://www.diodes.com>.

Marking Information

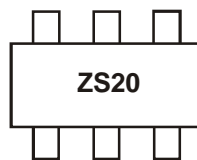

ZS20 = Product Type Marking Code

Maximum Ratings @T_A = 25°C unless otherwise specified

Characteristic	Symbol	Value	Units
Continuous Reverse Voltage	V _R	40	V
Continuous Forward Current	I _F	2	A
Average Peak Forward Current; D.C. = 50%	I _{FAV}	4	A
Non Repetitive Forward Current		t ≤ 100μs	A
		t ≤ 10ms	A

Thermal Characteristics

Characteristic	Symbol	Value	Unit
Power Dissipation, T _A = 25°C	P _D	1.1	W
Thermal Resistance, Junction to Ambient	R _{θJA}	(Note 2)	113
		(Note 3)	73
Junction Temperature	T _J	125	°C
Storage Temperature Range	T _{STG}	-55 to +150	°C

Notes: 2. For a device surface mounted on 25mm x 25mm FR4 PCB with high coverage of single sided 1oz copper, in still air conditions.
 3. For a device surface mounted on FR4 PCB measured at t ≤ 5 secs.

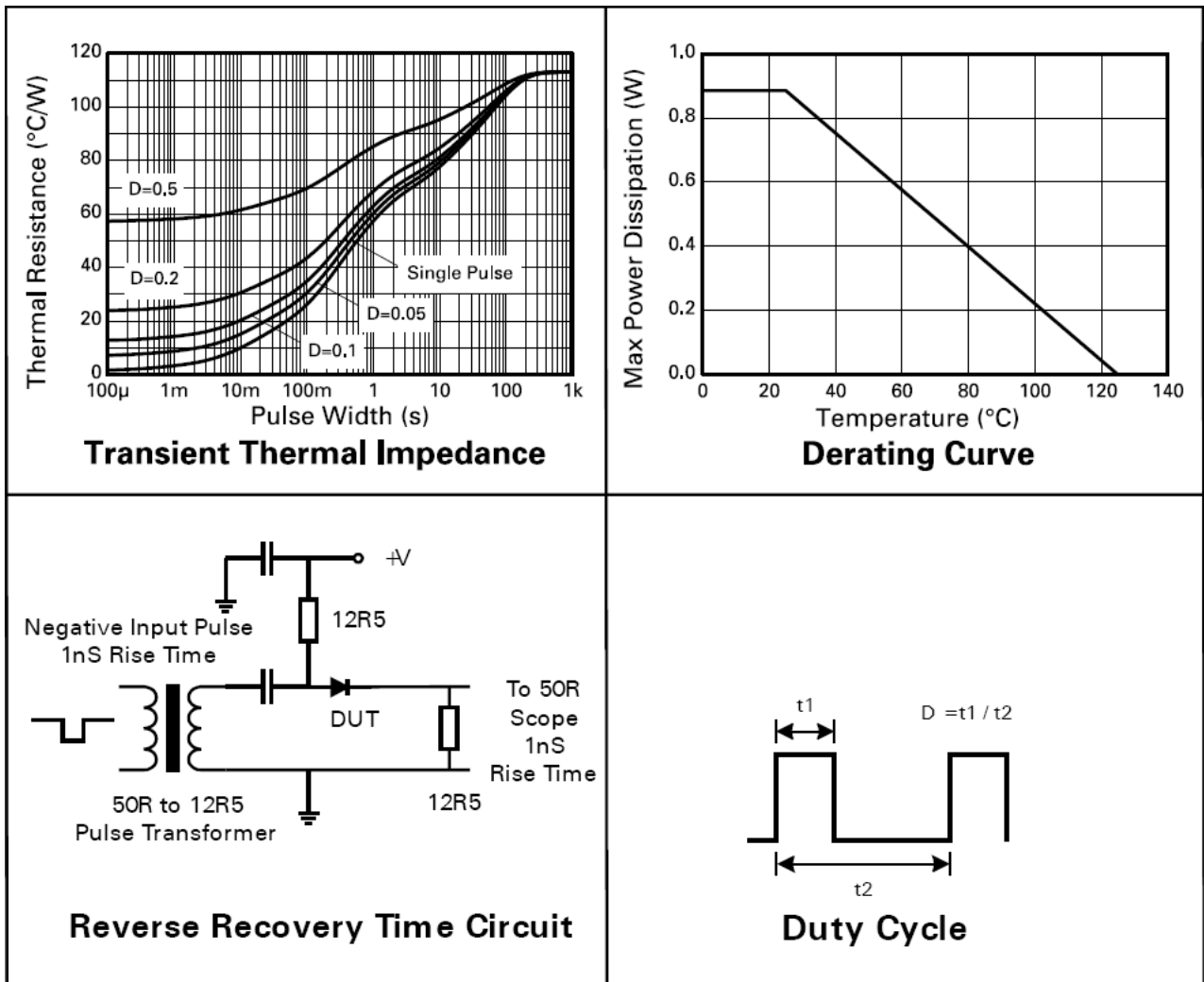

Electrical Characteristics @ $T_A = 25^\circ\text{C}$ unless otherwise specified

Characteristic	Symbol	Min	Typ	Max	Unit	Test Condition
Reverse Breakdown Voltage	$V_{(BR)R}$	40	-	-	V	$I_R = 1\text{mA}$
Forward Voltage (Note 4)	V_F	-	290	325	mV	$I_F = 500\text{mA}$
		-	340	385		$I_F = 1000\text{mA}$
		-	380	445		$I_F = 1500\text{mA}$
		-	420	500		$I_F = 2000\text{mA}$
		-	485	615		$I_F = 3000\text{mA}$
		-	420	-		$I_F = 2000\text{mA}, T_A = 100^\circ\text{C}$
Reverse Current	I_R	-	160	300	μA	$V_R = 30\text{V}$
Diode Capacitance	C_D	-	50	-	pF	$f = 1\text{MHz}, V_R = 25\text{V}$
Reverse Recovery Time	t_{rr}	-	5.5	-	ns	Switched from $I_F = 500\text{mA}$ to $I_R = 500\text{mA}$ Measured @ $I_R = 50\text{mA}$

Notes: 4. Measured under pulsed conditions. Pulse width = $300\mu\text{s}$. Duty cycle $\leq 2\%$.

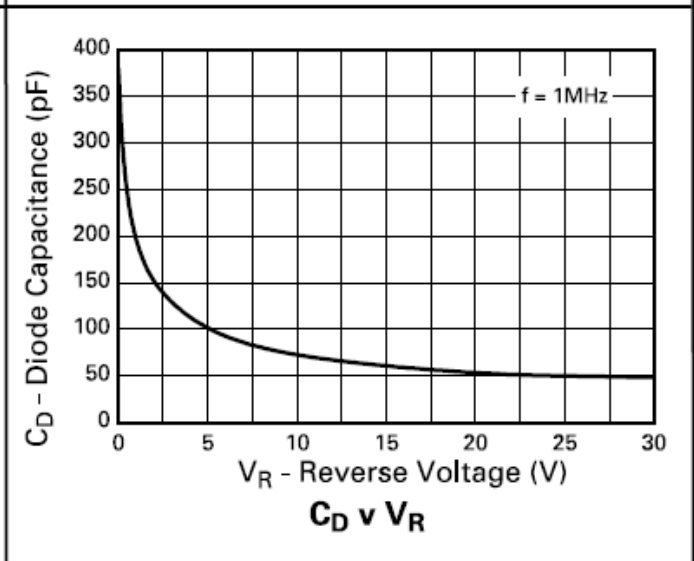
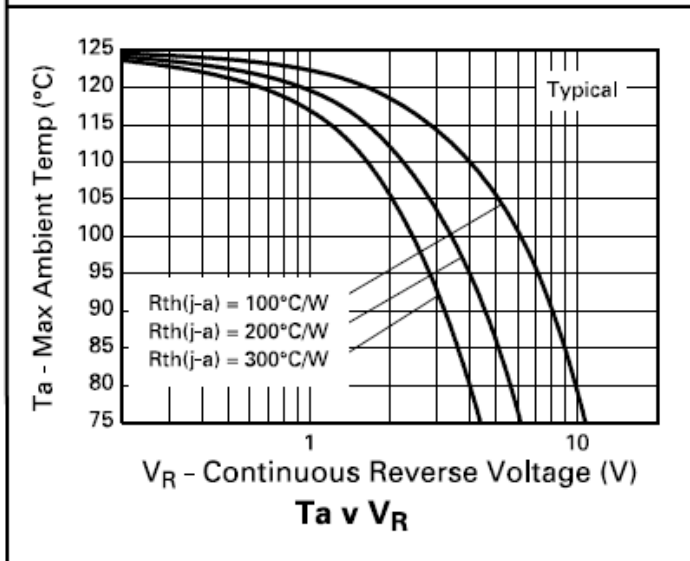
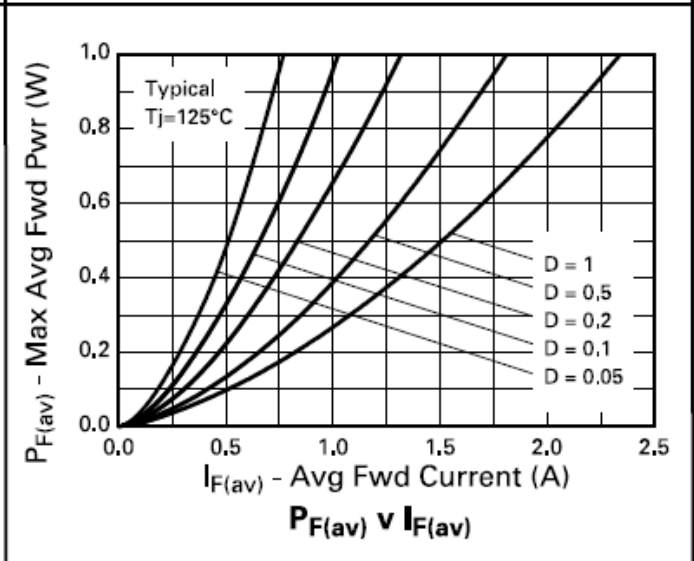
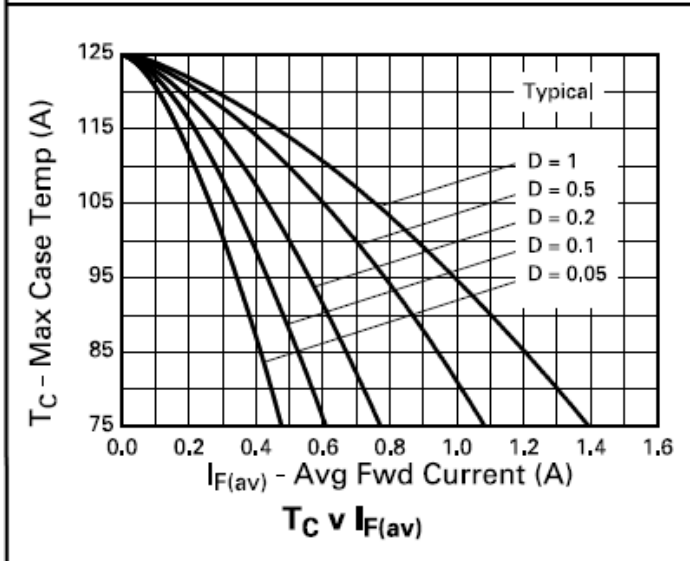
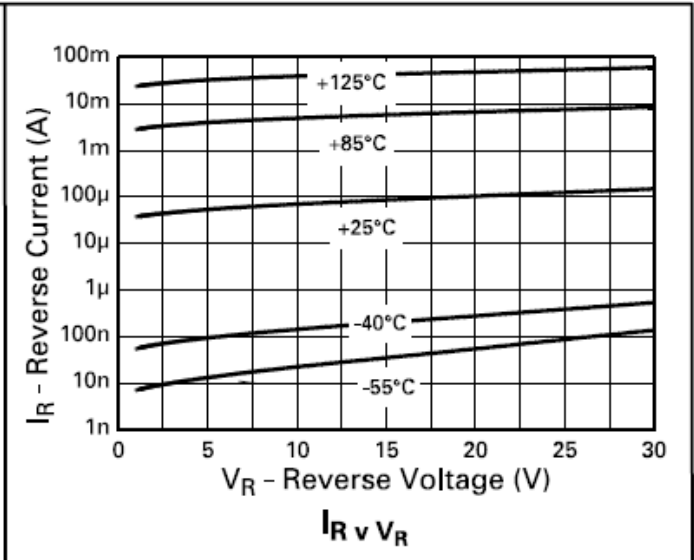
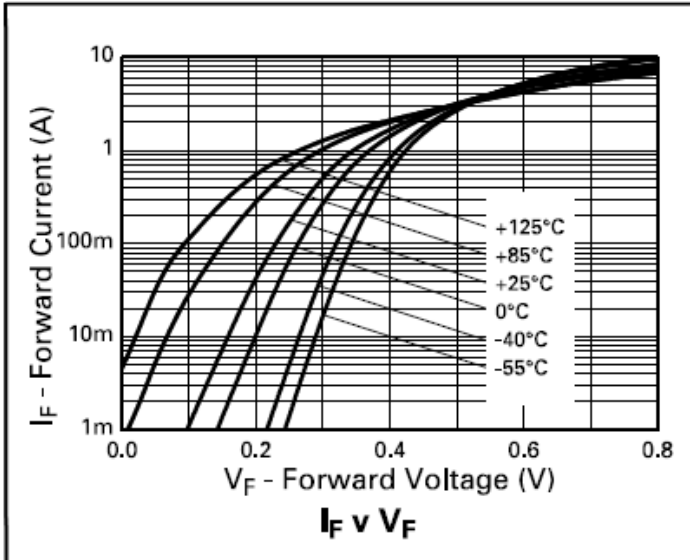

Package Outline Dimensions

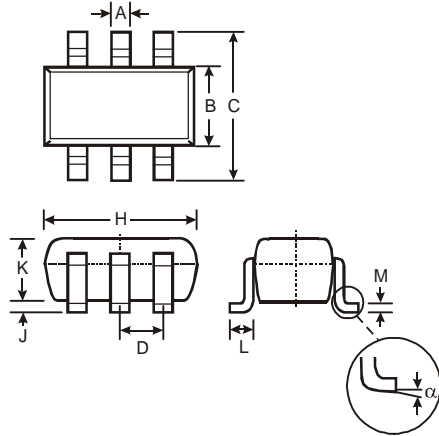

SOT26			
Dim	Min	Max	Typ
A	0.35	0.50	0.38
B	1.50	1.70	1.60
C	2.70	3.00	2.80
D	—	—	0.95
H	2.90	3.10	3.00
J	0.013	0.10	0.05
K	1.00	1.30	1.10
L	0.35	0.55	0.40
M	0.10	0.20	0.15
α	0°	8°	—
All Dimensions in mm			

Suggested Pad Layout

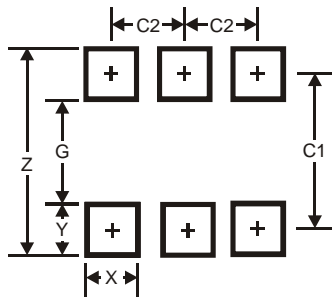

Dimensions	Value (in mm)
Z	3.20
G	1.60
X	0.55
Y	0.80
C1	2.40
C2	0.95

IMPORTANT NOTICE

DIODES INCORPORATED MAKES NO WARRANTY OF ANY KIND, EXPRESS OR IMPLIED, WITH REGARDS TO THIS DOCUMENT, INCLUDING, BUT NOT LIMITED TO, THE IMPLIED WARRANTIES OF MERCHANTABILITY AND FITNESS FOR A PARTICULAR PURPOSE (AND THEIR EQUIVALENTS UNDER THE LAWS OF ANY JURISDICTION).

Diodes Incorporated and its subsidiaries reserve the right to make modifications, enhancements, improvements, corrections or other changes without further notice to this document and any product described herein. Diodes Incorporated does not assume any liability arising out of the application or use of this document or any product described herein; neither does Diodes Incorporated convey any license under its patent or trademark rights, nor the rights of others. Any Customer or user of this document or products described herein in such applications shall assume all risks of such use and will agree to hold Diodes Incorporated and all the companies whose products are represented on Diodes Incorporated website, harmless against all damages.

Diodes Incorporated does not warrant or accept any liability whatsoever in respect of any products purchased through unauthorized sales channel. Should Customers purchase or use Diodes Incorporated products for any unintended or unauthorized application, Customers shall indemnify and hold Diodes Incorporated and its representatives harmless against all claims, damages, expenses, and attorney fees arising out of, directly or indirectly, any claim of personal injury or death associated with such unintended or unauthorized application.

Products described herein may be covered by one or more United States, international or foreign patents pending. Product names and markings noted herein may also be covered by one or more United States, international or foreign trademarks.

LIFE SUPPORT

Diodes Incorporated products are specifically not authorized for use as critical components in life support devices or systems without the express written approval of the Chief Executive Officer of Diodes Incorporated. As used herein:

A. Life support devices or systems are devices or systems which:

1. are intended to implant into the body, or
2. support or sustain life and whose failure to perform when properly used in accordance with instructions for use provided in the labeling can be reasonably expected to result in significant injury to the user.

B. A critical component is any component in a life support device or system whose failure to perform can be reasonably expected to cause the failure of the life support device or to affect its safety or effectiveness.

Customers represent that they have all necessary expertise in the safety and regulatory ramifications of their life support devices or systems, and acknowledge and agree that they are solely responsible for all legal, regulatory and safety-related requirements concerning their products and any use of Diodes Incorporated products in such safety-critical, life support devices or systems, notwithstanding any devices- or systems-related information or support that may be provided by Diodes Incorporated. Further, Customers must fully indemnify Diodes Incorporated and its representatives against any damages arising out of the use of Diodes Incorporated products in such safety-critical, life support devices or systems.

Copyright © 2011, Diodes Incorporated

www.diodes.com