

Features

- Glass Passivated Die Construction
- Super-Fast Switching for High Efficiency
- Surge Overload Rating to 60A Peak
- Low Reverse Leakage Current
- Lead Free Finish, RoHS Compliant (Note 4)

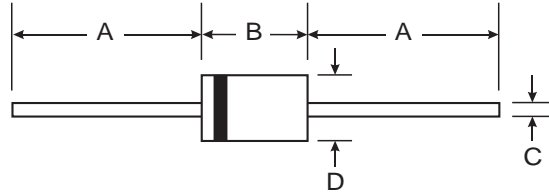

Mechanical Data

- Case: DO-15
- Case Material: Molded Plastic. UL Flammability Classification Rating 94V-0
- Moisture Sensitivity: Level 1 per J-STD-020C
- Terminals: Finish – Tin. Solderable per MIL-STD-202, Method 208 (E3)
- Polarity: Cathode Band
- Marking: Type Number
- Ordering Information: See Page 3
- Weight: 0.35 grams (approximate)

DO-15		
Dim	Min	Max
A	25.40	¾
B	5.50	7.62
C	0.686	0.889
D	2.60	3.6
All Dimensions in mm		

Maximum Ratings and Electrical Characteristics

@ T_A = 25°C unless otherwise specified

Single phase, half wave, 60Hz, resistive or inductive load.
For capacitive load, derate current by 20%.

Characteristic	Symbol	SF20 AG	SF20 BG	SF20 CG	SF20 DG	SF20 FG	SF20 GG	SF20 HG	SF20 JG	Unit	
Peak Repetitive Reverse Voltage Working Peak Reverse Voltage DC Blocking Voltage (Note 5)	V _{RRM} V _{RWM} V _R	50	100	150	200	300	400	500	600	V	
RMS Reverse Voltage	V _{R(RMS)}	35	70	105	140	210	280	350	420	V	
Average Rectified Output Current (Note 1) @ T _A = 75°C	I _O	2.0								A	
Non-Repetitive Peak Forward Surge Current 8.3ms Single half sine-wave Superimposed on Rated Load	I _{FSM}	60								A	
Forward Voltage @ I _F = 2.0A	V _{FM}	0.95			1.3		1.5			V	
Peak Reverse Current at Rated DC Blocking Voltage (Note 5) @ T _A = 25°C @ T _A = 100°C	I _{RM}	10				100					mA
Reverse Recovery Time (Note 2)	t _{rr}	35			40		50			ns	
Typical Total Capacitance (Note 3)	C _T	75						50			pF
Typical Thermal Resistance Junction to Ambient	R _{qJA}	40								°C/W	
Operating and Storage Temperature Range	T _j , T _{STG}	-65 to +150								°C	

- Notes:
1. Valid provided that leads are kept at ambient temperature at a distance of 9.5mm from the case.
 2. Measured with I_F = 0.5A, I_R = 1.0A, I_{rr} = 0.25A. See Figure 5.
 3. Measured at 1.0MHz and applied reverse voltage of 4.0V DC.
 4. RoHS revision 13.2.2003. Glass and high temperature solder exemptions applied, see EU Directive Annex Notes 5 and 7.
 5. Short duration pulse test used to minimize self-heating effect.

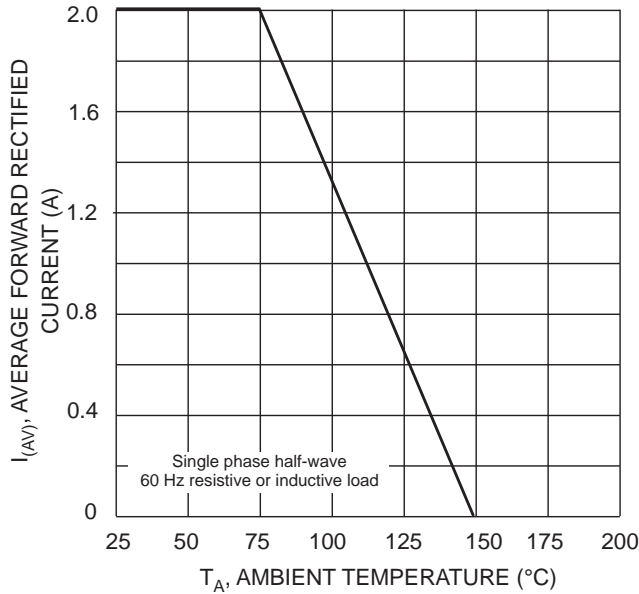

Fig. 1 Forward Current Derating Curve

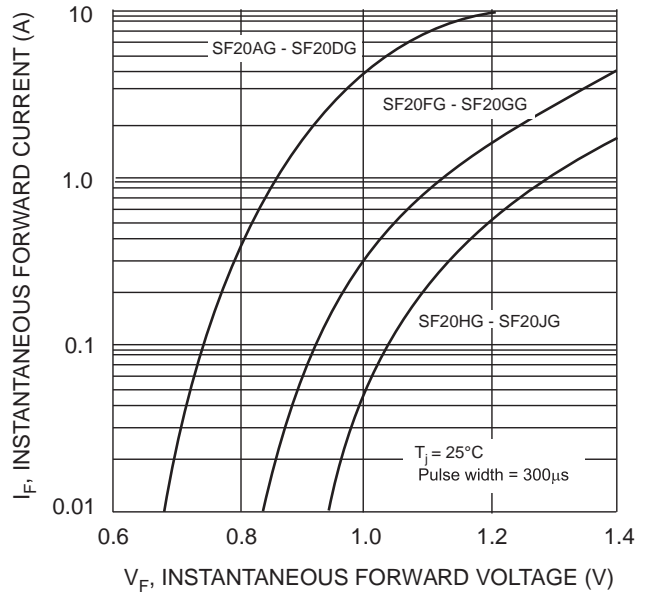

Fig. 2 Typical Forward Characteristics

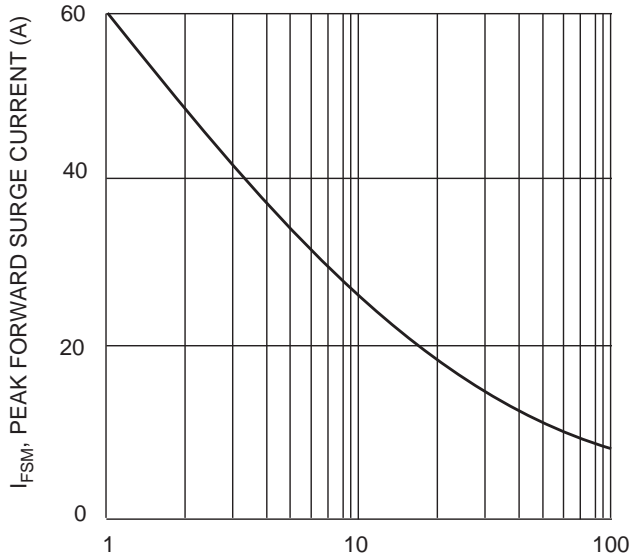

Fig. 3 Peak Forward Surge Current

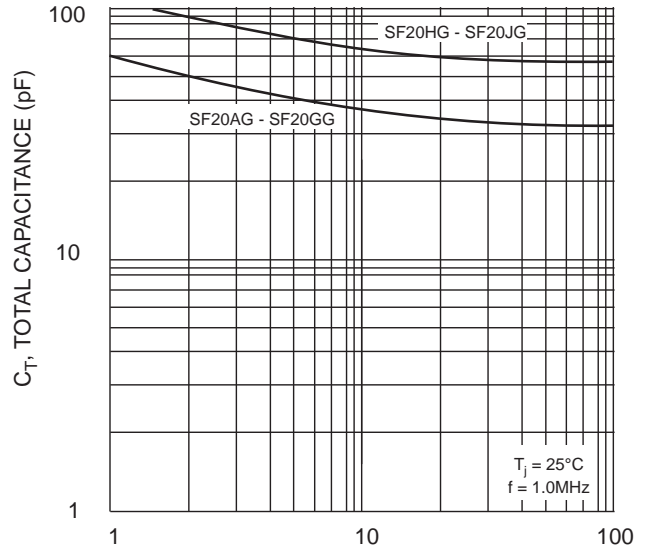
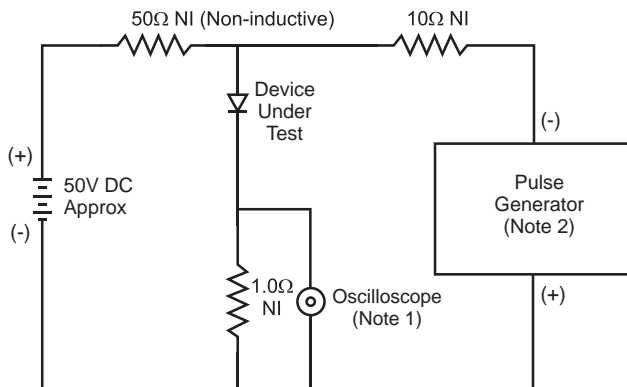
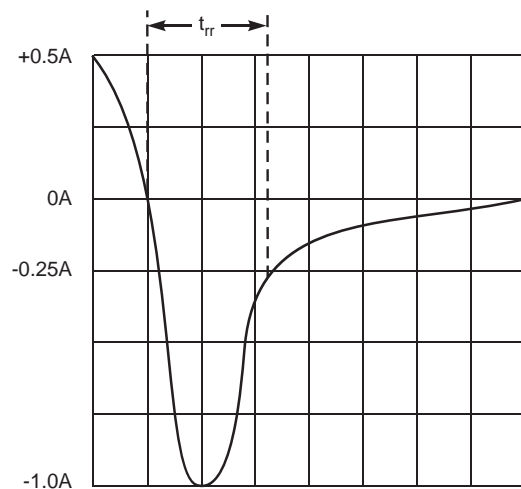

Fig. 4 Typical Total Capacitance



- Notes:
1. Rise Time = 7.0ns max. Input Impedance = 1.0MΩ, 22pF.
 2. Rise Time = 10ns max. Input Impedance = 50Ω.



Set time base for 50/100 ns/cm

Fig. 5 Reverse Recovery Time Characteristic and Test Circuit

Ordering Information (Note 6)

Device	Packaging	Shipping
SF20AG-T	DO-15	4K/Tape & Reel, 13-inch
SF20BG-T	DO-15	4K/Tape & Reel, 13-inch
SF20CG-T	DO-15	4K/Tape & Reel, 13-inch
SF20DG-T	DO-15	4K/Tape & Reel, 13-inch
SF20FG-T	DO-15	4K/Tape & Reel, 13-inch
SF20GG-T	DO-15	4K/Tape & Reel, 13-inch
SF20HG-T	DO-15	4K/Tape & Reel, 13-inch
SF20JG-T	DO-15	4K/Tape & Reel, 13-inch

Notes: 6. For packaging details, visit our website at <http://www.diodes.com/datasheets/ap02008.pdf>.

IMPORTANT NOTICE

Diodes Incorporated and its subsidiaries reserve the right to make modifications, enhancements, improvements or other changes without further notice to any product herein. Diodes Incorporated does not assume any liability arising out of the application or use of any product described herein; it does not convey any license under its patent rights or other rights. The user of products in such applications shall assume all risks of such use and agree to hold Diodes Incorporated and all the component products are represented on our website, liable for all damages.

LIFE SUPPORT

Diodes Incorporated products are not authorized for use as components in life support devices or systems without the written approval of the President of Diodes Incorporated.