

OAB800AN Series

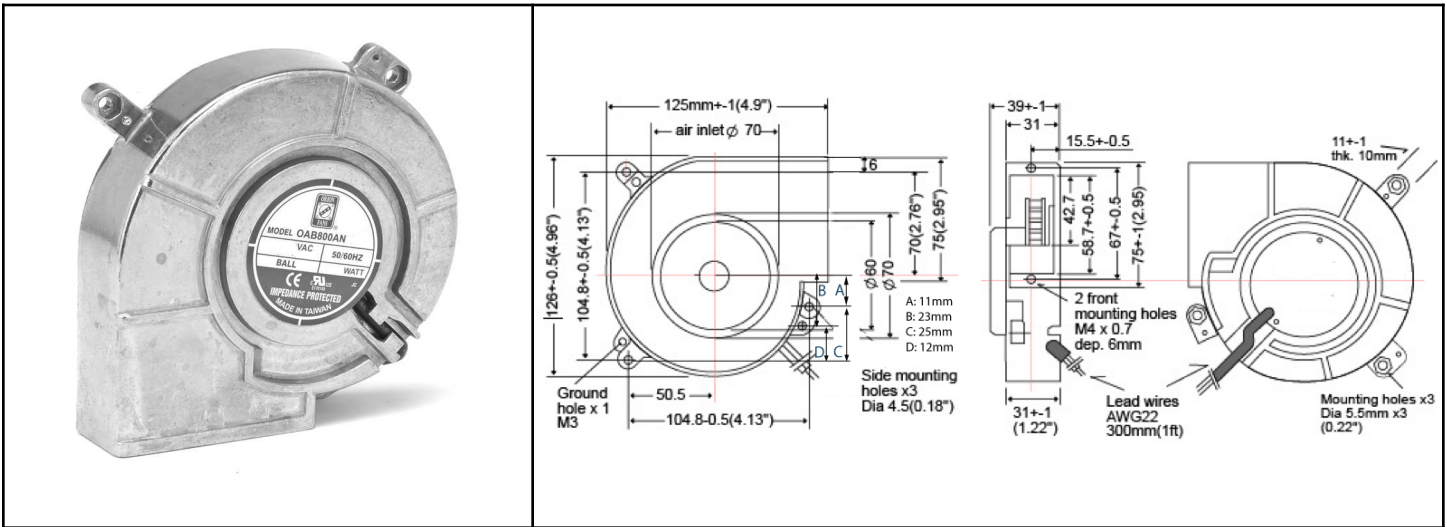

AC Blower, ball bearing
125x126x39mm (4.9"x 5"x 1.5")



Side Inlet Blower		<p>Operating Temp: Ambient non-condensing allowable thermal range -20C~+75C</p> <p>-L10 Life: MTBF life test 85,000 hours at +45C, 40,000 hours at +60C</p> <p>-Dielectric Strength: Over 1 min. at 1,500 VAC, 0.5mA, 50/60 Hz</p> <p>-Insulation Resistance: Over 100 Mega Ohm at DC 500V</p>	
Frame & Impeller	Aluminum die-cast shell with UL94V-0 impeller		
Connection	Lead Wires		
Motor	Shaded pole, inner rotor, single phase, impedance protected		
Bearing System	Dual ball - sealed		

	OAB800AN-11-2B	OAB800AN-22-2B
Model Number	OAB800AN-11-2B	OAB800AN-22-2B
Part Number	263321000	263621000
Nominal Voltage	115 VAC	230 VAC
Voltage Range	80 ~ 120	150 ~ 240
Rated Power	12 W	12 W
Rated Speed (RPM)	2100	2100
Airflow (CFM)	22	22
Noise Level (dB)	39	39
Max. Static Pressure	0.35 "H2O	0.35 "H2O