

OAB908 Side Inlet Blower

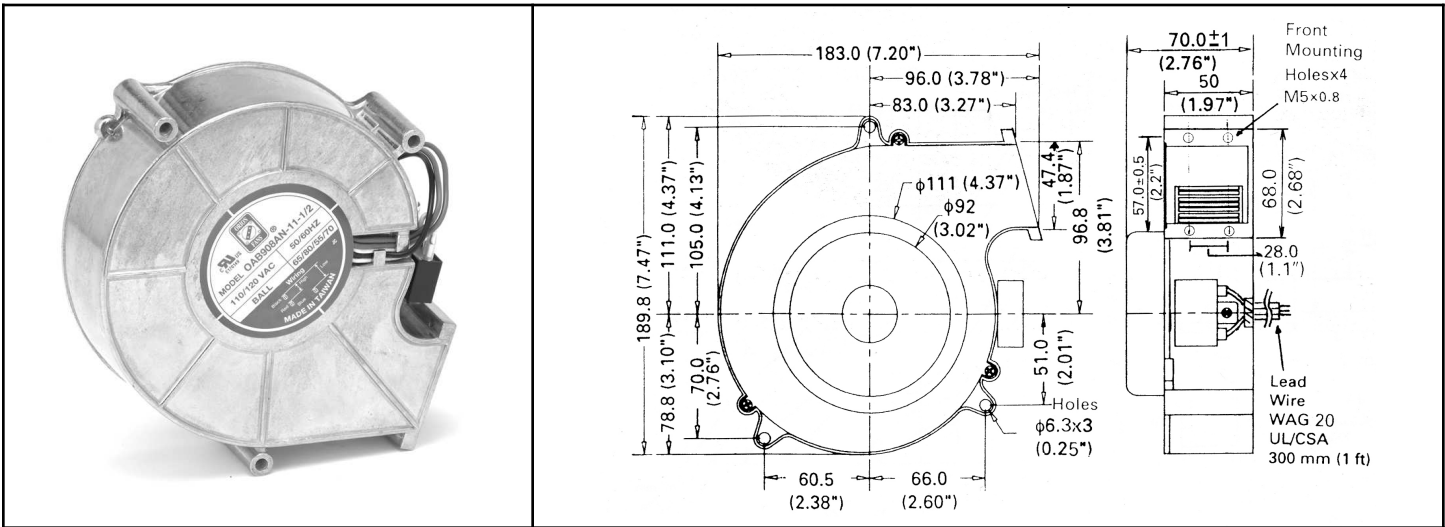

AC Blower, ball bearing, Dual Speed
183x190x70mm (7.2"x 7.5"x 2.8")



Dual Speed Blower (High, Medium)	
Frame & Impeller	Aluminum die-cast shell with UL94V-0 impeller
Connection	Lead Wires
Motor	Single phase, capacitor induction, 2/4 pole, inner rotor, thermal protection -Frame: Aluminum die-cast, natural color treatment case, steel plate housing cover
Bearing System	Dual ball - sealed

Operating Temp: Ambient non-condensing allowable thermal range -20C~+75C

-L10 Life: MTBF life test 80,000 hours at +45C, 40,000 hours at +60C

-Dielectric Strength: Over 1 min. at 1,500 VAC, 0.5mA, 50/60 Hz

-Insulation Resistance: Over 100 Mega Ohm at DC 500V

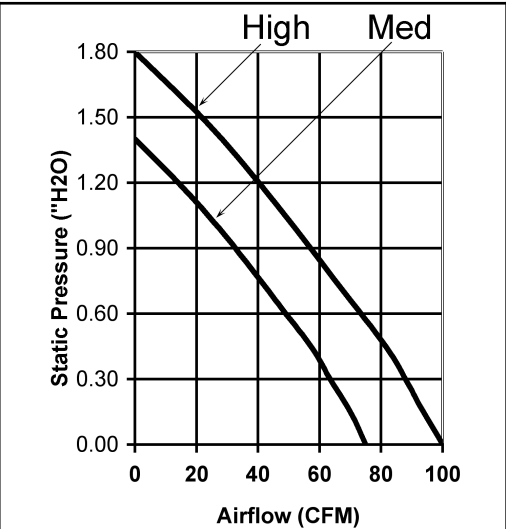

Model Number	OAB908AN-22-1/2
Part Number	264611060
Nominal Voltage	220 VAC
Voltage Range	200 ~ 240 VAC
Rated Power	65 W / 45 W
Rated Speed (RPM)	3100 / 2400
Airflow (CFM)	100 / 75
Noise Level (dB)	68 / 55
Max. Static Pressure	1.8 "H2O / 1.4 "H2O