

ZXTN4006Z

200V NPN LED DRIVING TRANSISTOR IN SOT89

Features

- $BV_{CEO} > 200V$
- Max continuous current $I_C = 1A$
- $h_{FE} > 100 @ I_C = 150mA, V_{CE} = 320mV$
- **Lead Free, RoHS Compliant (Note 1)**
- **Halogen and Antimony Free "Green" Device (Note 2)**
- **Qualified to AEC-Q101 Standards for High Reliability**

Applications

- LED TV backlight

Mechanical Data

- Case: SOT89
- Case material: molded Plastic. "Green" molding Compound.
- UL Flammability Rating 94V-0
- Moisture Sensitivity: Level 1 per J-STD-020
- Terminals: Matte Tin Finish
- Weight: 0.052 grams (Approximate)

SOT89

Top View

Device symbol

Top View
Pin Out

Ordering Information (Note 3)

Product	Marking	Reel size (inches)	Tape width (mm)	Quantity per reel
ZXTN4006ZTA	1S5	7	12	1000 units

- Notes:
1. No purposefully added lead.
 2. Diodes Inc's "Green" Policy can be found on our website at <http://www.diodes.com>
 3. For Packaging Details, go to our website at <http://www.diodes.com>.

Marking Information

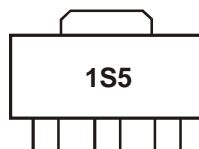

1S5 = Product type Marking Code

Maximum Ratings @T_A = 25°C unless otherwise specified

Characteristic	Symbol	Value	Unit
Collector-Base Voltage	V _{CBO}	200	V
Collector-Emitter Voltage	V _{CEO}	200	V
Emitter-Base Voltage	V _{EBO}	7	V
Continuous Collector Current	I _C	1	A
Peak Pulse Current (Note 4)	I _{CM}	3	A
Base Current	I _B	500	mA

Thermal Characteristics @T_A = 25°C unless otherwise specified

Characteristic	Symbol	Value	Unit
Power Dissipation (Note 5)	P _D	1.5	W
Thermal Resistance, Junction to Ambient (Note 5)	R _{θJA}	83	°C/W
Thermal Resistance, Junction to Leads (Note 6)	R _{θJL}	16.7	°C/W
Operating and Storage Temperature Range	T _J , T _{STG}	-55 to +150	°C

- Notes:
4. Measured under pulsed conditions. Pulse width = 300µs. Duty cycle ≤ 2%.
 5. For a device surface mounted on 25mm X 25mm FR4 PCB with high coverage of single sided 1 oz copper, in still air conditions
 6. Thermal resistance from junction to solder-point (at the end of the collector lead).

Thermal Characteristics and Derating information

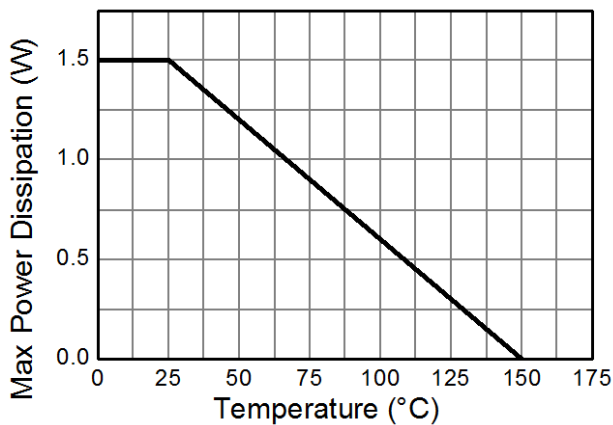

Derating Curve

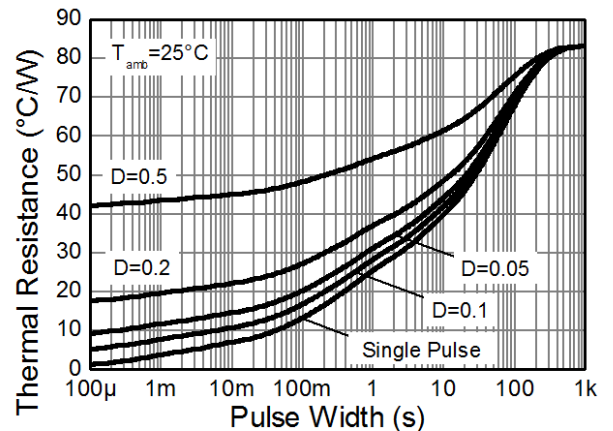

Transient Thermal Impedance

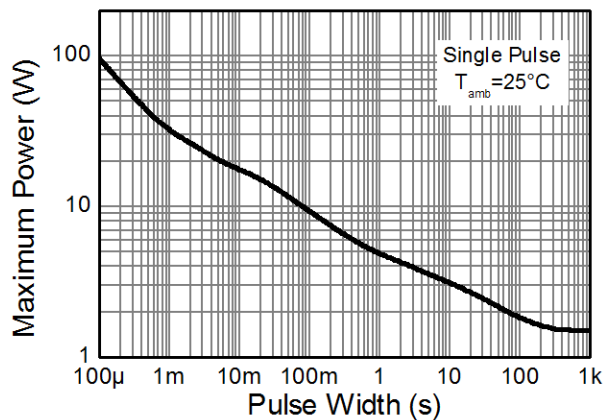

Pulse Power Dissipation

Electrical Characteristics @T_A = 25°C unless otherwise specified

Characteristic	Symbol	Min	Typ	Max	Unit	Test Condition
Collector-Emitter Breakdown Voltage (Note 7)	BV _{CEO}	200	-	-	V	I _C = 10mA
Collector Cut-off Current	I _{CBO}	-	-	50	nA	V _{CB} = 200V
Emitter Cut-off Current	I _{EBO}	-	-	50	nA	V _{EB} = 7V
Static Forward Current Transfer Ratio (Note 7)	h _{FE}	60 100	- -	- -	-	I _C = 85mA, V _{CE} = 0.25V I _C = 150mA, V _{CE} = 0.32V
Base-Emitter Turn-On Voltage (Note 7)	V _{BE(on)}	-	0.72	0.95	V	I _C = 150mA, V _{CE} = 0.32V
Delay Time	t _(d)	-	600	-	ns	V _{CC} = 160V, I _C = 150mA, -I _{B2} = 1.5mA, V _{CE(ON)} = 0.32V
Rise Time	t _(r)	-	496	-	ns	
Storage Time	t _(s)	-	2730	-	ns	
Fall Time	t _(f)	-	293	-	ns	
Storage Time	t _(s)	-	56	-	ns	V _{CC} = 80V, I _C = 150mA, I _{B1} = -I _{B2} = 1.5mA, V _{CE(ON)} = 4V
Fall Time	t _(f)	-	243	-	ns	

Notes: 7. Measured under pulsed conditions. Pulse width = 300µs. Duty cycle ≤ 2%

Electrical Characteristics

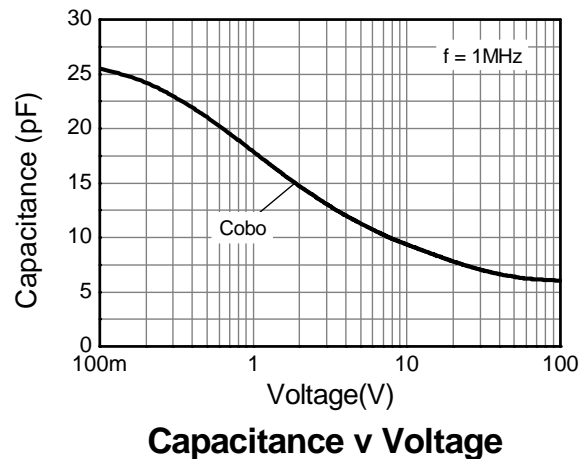
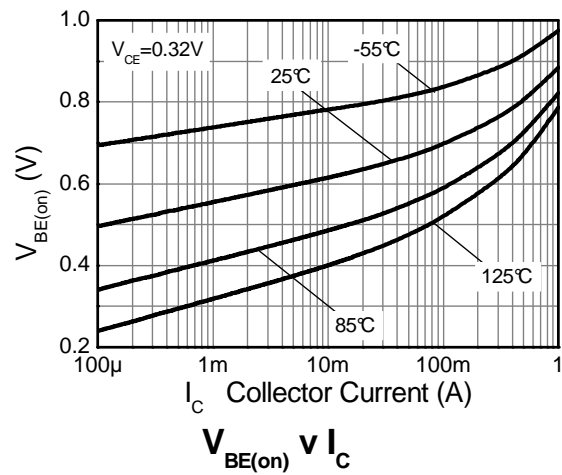
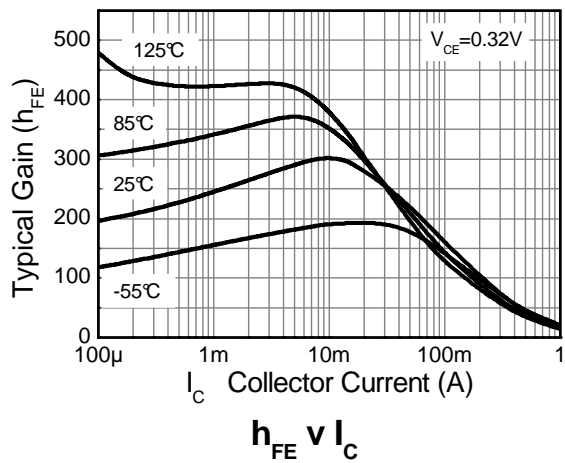

ZXTN4006Z

Package Outline Dimensions

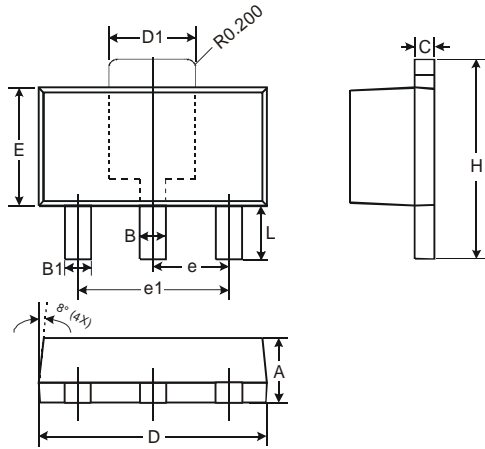

SOT89		
Dim	Min	Max
A	1.40	1.60
B	0.44	0.62
B1	0.35	0.54
C	0.35	0.43
D	4.40	4.60
D1	1.52	1.83
E	2.29	2.60
e	1.50 Typ	
e1	3.00 Typ	
H	3.94	4.25
L	0.89	1.20
All Dimensions in mm		

Suggested Pad Layout

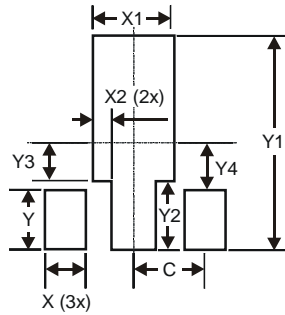

Dimensions	Value (in mm)
X	0.900
X1	1.733
X2	0.416
Y	1.300
Y1	4.600
Y2	1.475
Y3	0.950
Y4	1.125
C	1.500

IMPORTANT NOTICE

DIODES INCORPORATED MAKES NO WARRANTY OF ANY KIND, EXPRESS OR IMPLIED, WITH REGARDS TO THIS DOCUMENT, INCLUDING, BUT NOT LIMITED TO, THE IMPLIED WARRANTIES OF MERCHANTABILITY AND FITNESS FOR A PARTICULAR PURPOSE (AND THEIR EQUIVALENTS UNDER THE LAWS OF ANY JURISDICTION).

Diodes Incorporated and its subsidiaries reserve the right to make modifications, enhancements, improvements, corrections or other changes without further notice to this document and any product described herein. Diodes Incorporated does not assume any liability arising out of the application or use of this document or any product described herein; neither does Diodes Incorporated convey any license under its patent or trademark rights, nor the rights of others. Any Customer or user of this document or products described herein in such applications shall assume all risks of such use and will agree to hold Diodes Incorporated and all the companies whose products are represented on Diodes Incorporated website, harmless against all damages.

Diodes Incorporated does not warrant or accept any liability whatsoever in respect of any products purchased through unauthorized sales channel. Should Customers purchase or use Diodes Incorporated products for any unintended or unauthorized application, Customers shall indemnify and hold Diodes Incorporated and its representatives harmless against all claims, damages, expenses, and attorney fees arising out of, directly or indirectly, any claim of personal injury or death associated with such unintended or unauthorized application.

Products described herein may be covered by one or more United States, international or foreign patents pending. Product names and markings noted herein may also be covered by one or more United States, international or foreign trademarks.

LIFE SUPPORT

Diodes Incorporated products are specifically not authorized for use as critical components in life support devices or systems without the express written approval of the Chief Executive Officer of Diodes Incorporated. As used herein:

A. Life support devices or systems are devices or systems which:

1. are intended to implant into the body, or
2. support or sustain life and whose failure to perform when properly used in accordance with instructions for use provided in the labeling can be reasonably expected to result in significant injury to the user.

B. A critical component is any component in a life support device or system whose failure to perform can be reasonably expected to cause the failure of the life support device or to affect its safety or effectiveness.

Customers represent that they have all necessary expertise in the safety and regulatory ramifications of their life support devices or systems, and acknowledge and agree that they are solely responsible for all legal, regulatory and safety-related requirements concerning their products and any use of Diodes Incorporated products in such safety-critical, life support devices or systems, notwithstanding any devices- or systems-related information or support that may be provided by Diodes Incorporated. Further, Customers must fully indemnify Diodes Incorporated and its representatives against any damages arising out of the use of Diodes Incorporated products in such safety-critical, life support devices or systems.

Copyright © 2012, Diodes Incorporated

www.diodes.com