

2N6071A/B Series

Preferred Device

Sensitive Gate Triacs

Silicon Bidirectional Thyristors

Designed primarily for full-wave AC control applications, such as light dimmers, motor controls, heating controls and power supplies; or wherever full-wave silicon gate controlled solid-state devices are needed. Triac type thyristors switch from a blocking to a conducting state for either polarity of applied anode voltage with positive or negative gate triggering.

Features

- Sensitive Gate Triggering Uniquely Compatible for Direct Coupling to TTL, HTL, CMOS and Operational Amplifier Integrated Circuit Logic Functions
- Gate Triggering: 4 Mode - 2N6071A, B; 2N6073A, B; 2N6075A, B
- Blocking Voltages to 600 V
- All Diffused and Glass Passivated Junctions for Greater Parameter Uniformity and Stability
- Small, Rugged, Thermopad Construction for Low Thermal Resistance, High Heat Dissipation and Durability
- Device Marking: Device Type, e.g., 2N6071A, Date Code



ON Semiconductor®

<http://onsemi.com>

TRIACS

4.0 A RMS, 200 – 600 V

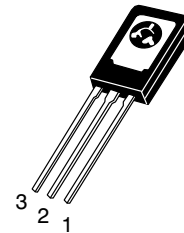
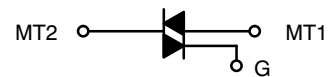

REAR VIEW
SHOW TAB

TO-225
CASE 077
STYLE 5

MARKING DIAGRAM

1. Cathode
2. Anode
3. Gate

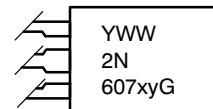

x = 1, 3, 5
y = A, B
Y = Year
WW = Work Week
G = Pb-Free Package

ORDERING INFORMATION

See detailed ordering and shipping information in the package dimensions section on page 7 of this data sheet.

Preferred devices are recommended choices for future use and best overall value.

*For additional information on our Pb-Free strategy and soldering details, please download the ON Semiconductor Soldering and Mounting Techniques Reference Manual, SOLDERRM/D.

2N6071A/B Series

MAXIMUM RATINGS ($T_J = 25^\circ\text{C}$ unless otherwise noted)

| Rating | Symbol | Value | Unit |
|---|--|-------------------|----------------------|
| *Peak Repetitive Off-State Voltage (Note 1) ($T_J = -40$ to 110°C , Sine Wave, 50 to 60 Hz, Gate Open) 2N6071A,B 2N6073A,B 2N6075A,B | V_{DRM} , V_{RRM} | 200 400 600 | V |
| *On-State RMS Current ($T_C = 85^\circ\text{C}$) Full Cycle Sine Wave 50 to 60 Hz | $I_{\text{T(RMS)}}$ | 4.0 | A |
| *Peak Non-repetitive Surge Current (One Full cycle, 60 Hz, $T_J = +110^\circ\text{C}$) | I_{TSM} | 30 | A |
| Circuit Fusing Considerations ($t = 8.3$ ms) | I^2t | 3.7 | A^2s |
| *Peak Gate Power (Pulse Width ≤ 1.0 μs , $T_C = 85^\circ\text{C}$) | P_{GM} | 10 | W |
| *Average Gate Power ($t = 8.3$ ms, $T_C = 85^\circ\text{C}$) | $P_{\text{G(AV)}}$ | 0.5 | W |
| *Peak Gate Voltage (Pulse Width ≤ 1.0 μs , $T_C = 85^\circ\text{C}$) | V_{GM} | 5.0 | V |
| *Operating Junction Temperature Range | T_J | -40 to +110 | $^\circ\text{C}$ |
| *Storage Temperature Range | T_{stg} | -40 to +150 | $^\circ\text{C}$ |
| Mounting Torque (6-32 Screw) (Note 2) | - | 8.0 | in. lb. |

Stresses exceeding Maximum Ratings may damage the device. Maximum Ratings are stress ratings only. Functional operation above the Recommended Operating Conditions is not implied. Extended exposure to stresses above the Recommended Operating Conditions may affect device reliability.

- V_{DRM} and V_{RRM} for all types can be applied on a continuous basis. Blocking voltages shall not be tested with a constant current source such that the voltage ratings of the devices are exceeded.
- Torque rating applies with use of a compression washer. Mounting torque in excess of 6 in. lb. does not appreciably lower case-to-sink thermal resistance. Main terminal 2 and heatsink contact pad are common.

THERMAL CHARACTERISTICS

| Characteristic | Symbol | Max | Unit |
|---|-----------------------|-----|--------------------|
| *Thermal Resistance, Junction-to-Case | $R_{\theta\text{JC}}$ | 3.5 | $^\circ\text{C/W}$ |
| Thermal Resistance, Junction-to-Ambient | $R_{\theta\text{JA}}$ | 75 | $^\circ\text{C/W}$ |
| Maximum Lead Temperature for Soldering Purposes 1/8" from Case for 10 Seconds | T_L | 260 | $^\circ\text{C}$ |

*Indicates JEDEC Registered Data.

2N6071A/B Series

ELECTRICAL CHARACTERISTICS ($T_C = 25^\circ\text{C}$ unless otherwise noted; Electricals apply in both directions)

| Characteristic | Symbol | Min | Typ | Max | Unit |
|----------------|--------|-----|-----|-----|------|
|----------------|--------|-----|-----|-----|------|

OFF CHARACTERISTICS

| | | | | | |
|---|--------------------------|---|---|---------|---------------------|
| *Peak Repetitive Blocking Current ($V_D = V_{DRM} = V_{RRM}$; Gate Open) | I_{DRM} , I_{RRM} | - | - | 10 2 | μA mA |
| $T_J = 25^\circ\text{C}$ $T_J = 110^\circ\text{C}$ | | | | | |

ON CHARACTERISTICS

| | | | | | |
|---|----------|-----|-----|----------|---------------|
| *Peak On-State Voltage (Note 3) ($I_{TM} = \pm 6.0$ A Peak) | V_{TM} | - | - | 2 | V |
| *Gate Trigger Voltage (Continuous DC), All Quadrants (Main Terminal Voltage = 12 Vdc, $R_L = 100 \Omega$, $T_J = -40^\circ\text{C}$) | V_{GT} | - | 1.4 | 2.5 | V |
| Gate Non-Trigger Voltage, All Quadrants (Main Terminal Voltage = 12 Vdc, $R_L = 100 \Omega$, $T_J = 110^\circ\text{C}$) | V_{GD} | 0.2 | - | - | V |
| *Holding Current (Main Terminal Voltage = 12 Vdc, Gate Open, Initiating Current = ± 1 Adc) | I_H | - | - | 30 15 | mA |
| $T_J = -40^\circ\text{C}$ $T_J = 25^\circ\text{C}$ | | | | | |
| Turn-On Time ($I_{TM} = 14$ Adc, $I_{GT} = 100$ mAdc) | t_{gt} | - | 1.5 | - | μs |

**QUADRANT
(Maximum Value)**

| | Type | I _{GT} @ T _J | I mA | II mA | III mA | IV mA |
|---|---------|----------------------------------|---------|----------|-----------|----------|
| Gate Trigger Current (Continuous DC) (Main Terminal Voltage = 12 Vdc, $R_L = 100 \Omega$) | 2N6071A | +25°C | 5 | 5 | 5 | 10 |
| | 2N6073A | | | | | |
| | 2N6075A | -40°C | 20 | 20 | 20 | 30 |
| | 2N6071B | -40°C | 15 | 15 | 15 | 20 |
| | 2N6073B | | | | | |
| | 2N6075B | | | | | |

DYNAMIC CHARACTERISTICS

| | | | | | |
|---|------------|---|---|---|------------------------|
| Critical Rate of Rise of Commutation Voltage @ V_{DRM} , $T_J = 85^\circ\text{C}$, Gate Open, $I_{TM} = 5.7$ A, Exponential Waveform, Commutating $di/dt = 2.0$ A/ms | $dv/dt(c)$ | - | 5 | - | $\text{V}/\mu\text{s}$ |
|---|------------|---|---|---|------------------------|

3. Pulse Test: Pulse Width ≤ 2.0 ms, Duty Cycle $\leq 2\%$.

*Indicates JEDEC Registered Data.

**SAMPLE APPLICATION:
TTL-SENSITIVE GATE 4 AMPERE TRIAC
TRIGGERS IN MODES II AND III**

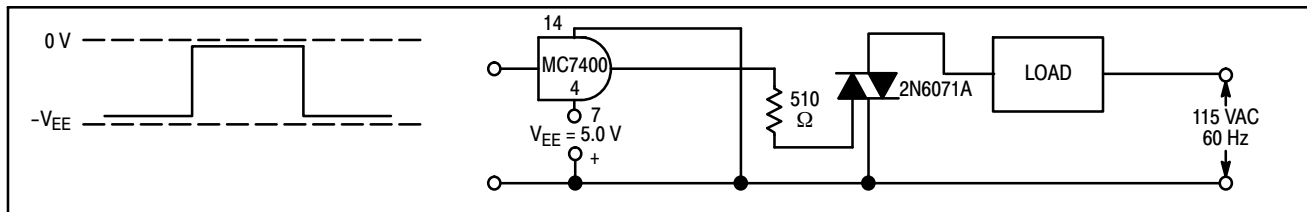

Trigger devices are recommended for gating on Triacs. They provide:

1. Consistent predictable turn-on points.
2. Simplified circuitry.
3. Fast turn-on time for cooler, more efficient and reliable operation.

2N6071A/B Series

Voltage Current Characteristic of Triacs (Bidirectional Device)

| Symbol | Parameter |
|-----------|---|
| V_{DRM} | Peak Repetitive Forward Off State Voltage |
| I_{DRM} | Peak Forward Blocking Current |
| V_{RRM} | Peak Repetitive Reverse Off State Voltage |
| I_{RRM} | Peak Reverse Blocking Current |
| V_{TM} | Maximum On State Voltage |
| I_H | Holding Current |

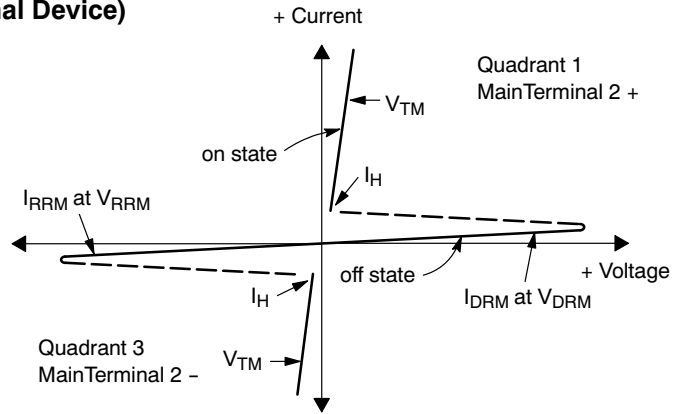

Quadrant Definitions for a Triac

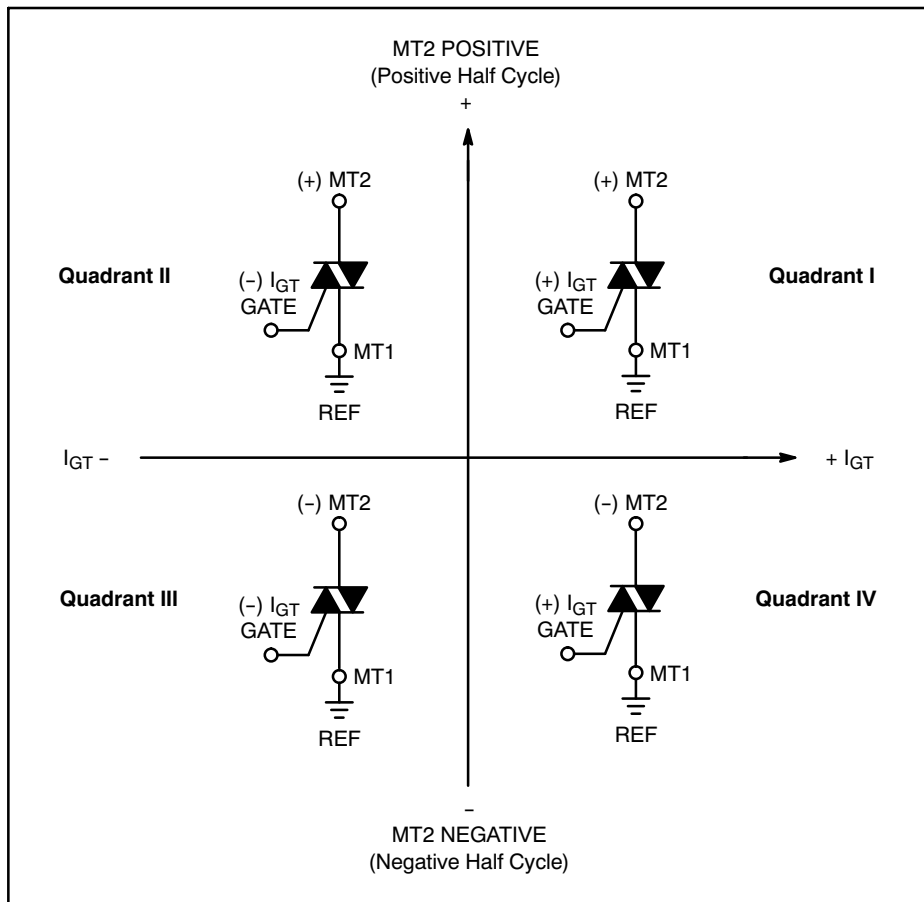

All polarities are referenced to MT1.
With in-phase signals (using standard AC lines) quadrants I and III are used.

SENSITIVE GATE LOGIC REFERENCE

| IC Logic Functions | Firing Quadrant | | | |
|-----------------------|-----------------|----------------|----------------|----------------|
| | I | II | III | IV |
| TTL | | 2N6071A Series | 2N6071A Series | |
| HTL | | 2N6071A Series | 2N6071A Series | |
| CMOS (NAND) | 2N6071B Series | | | 2N6071B Series |
| CMOS (Buffer) | | 2N6071B Series | 2N6071B Series | |
| Operational Amplifier | 2N6071A Series | | | 2N6071A Series |
| Zero Voltage Switch | | 2N6071A Series | 2N6071A Series | |

2N6071A/B Series

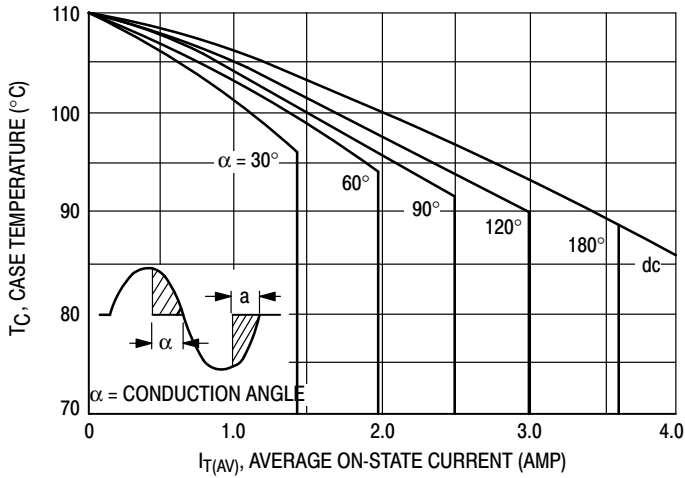

Figure 1. Average Current Derating

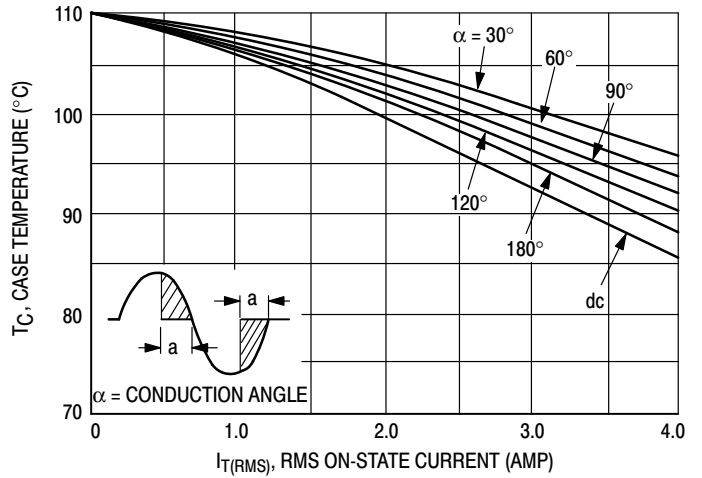

Figure 2. RMS Current Derating

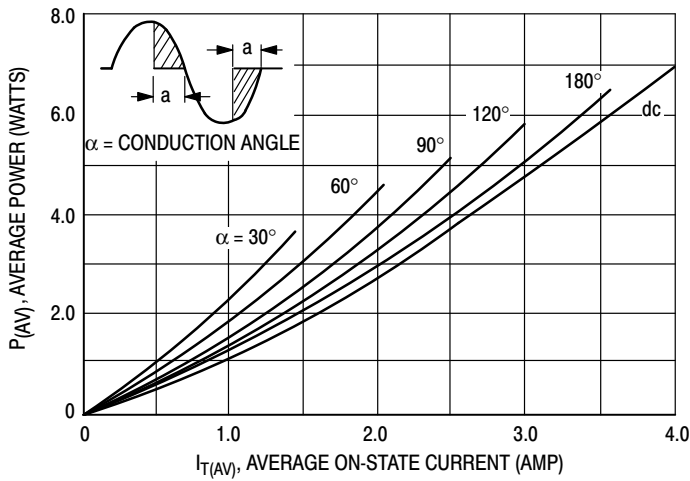

Figure 3. Power Dissipation

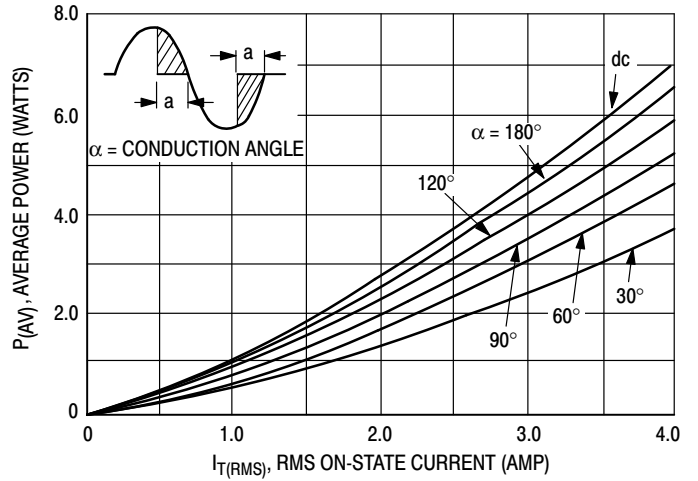

Figure 4. Power Dissipation

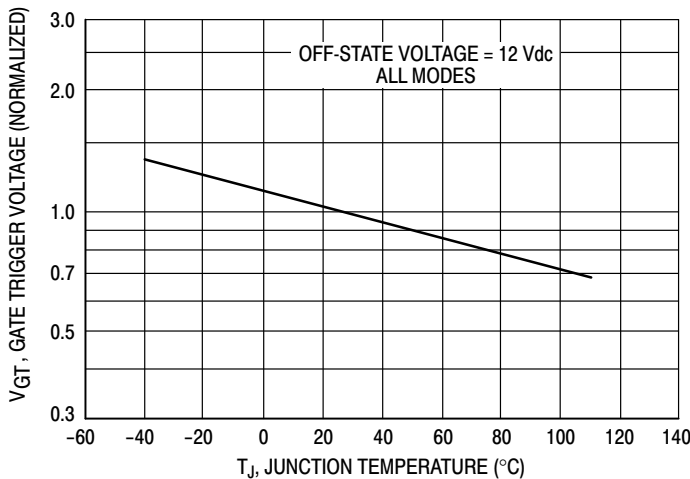

Figure 5. Typical Gate-Trigger Voltage

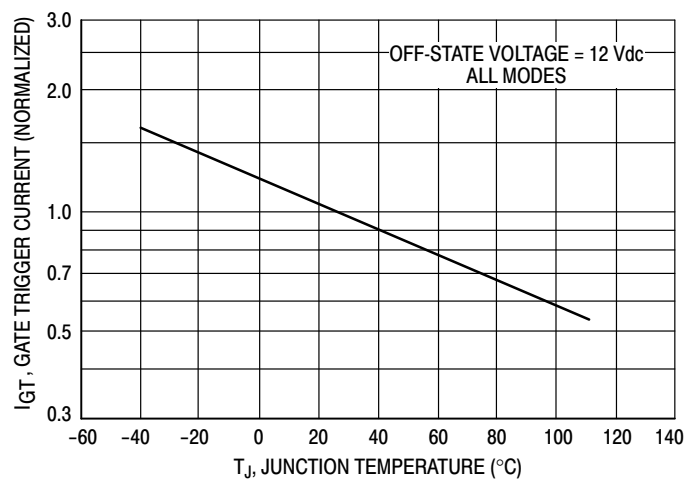

Figure 6. Typical Gate-Trigger Current

2N6071A/B Series

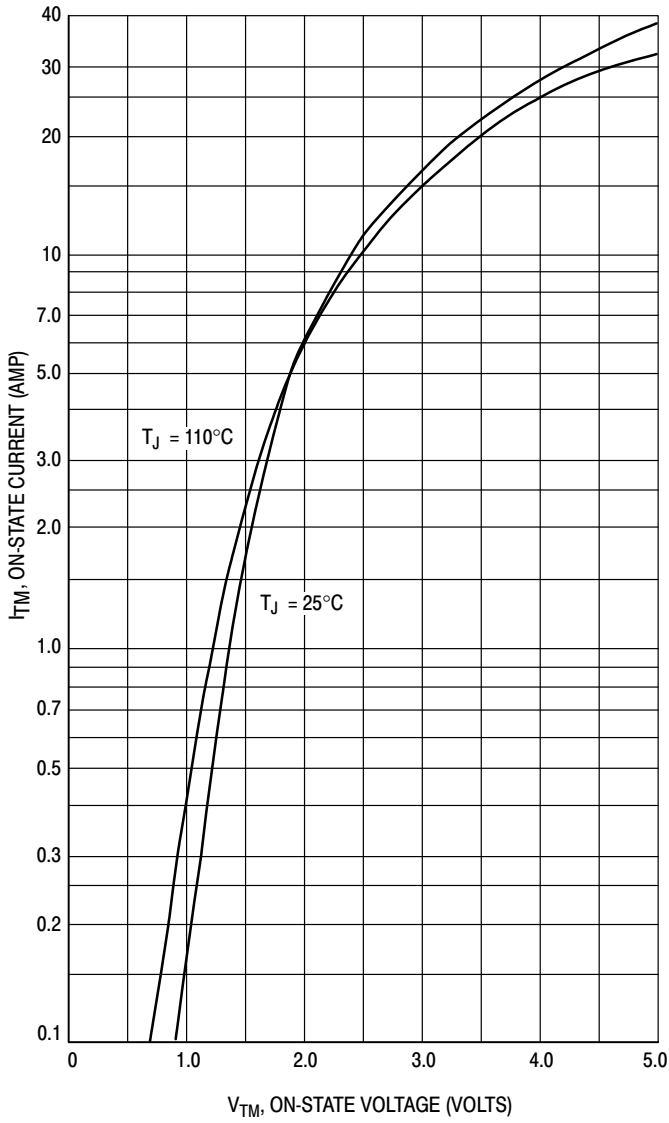

Figure 7. Maximum On-State Characteristics

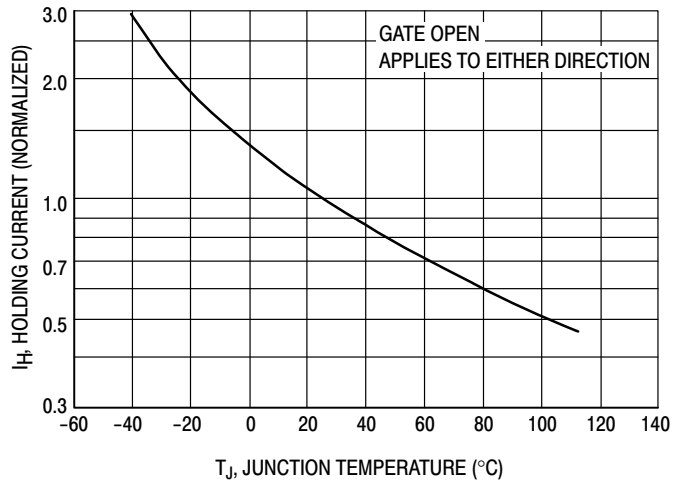

Figure 8. Typical Holding Current

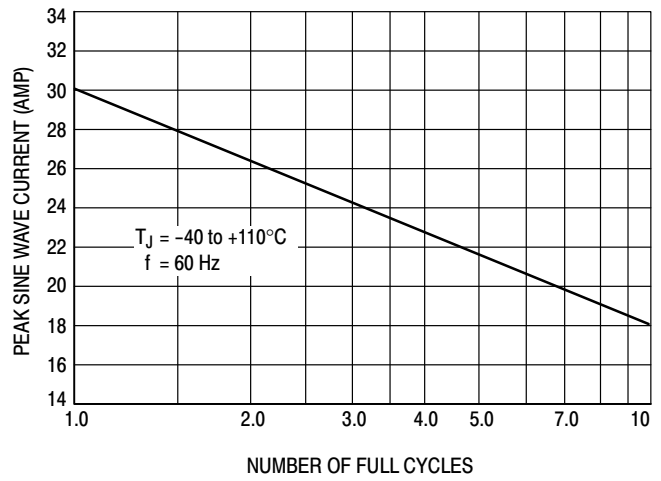

Figure 9. Maximum Allowable Surge Current

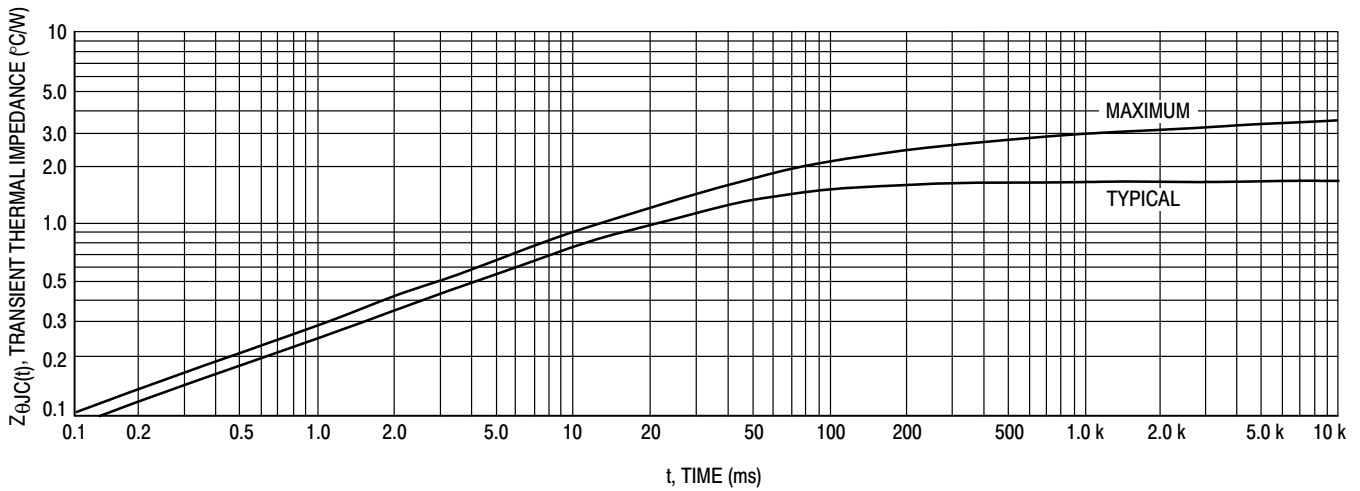

Figure 10. Thermal Response

2N6071A/B Series

ORDERING INFORMATION

| Device | Package | Shipping† |
|-----------|---------------------|-------------------------------------|
| 2N6071A | TO-225 | 500 Units / Box |
| 2N6071AG | TO-225 (Pb-Free) | |
| 2N6071AT | TO-225 | 50 Units / Tube 2000 Units / Box |
| 2N6071ATG | TO-225 (Pb-Free) | 50 Units / Tube 2000 Units / Box |
| 2N6071B | TO-225 | 500 Units / Box |
| 2N6071BG | TO-225 (Pb-Free) | |
| 2N6071BT | TO-225 | 50 Units / Tube 2000 Units / Box |
| 2N6071BTG | TO-225 (Pb-Free) | 50 Units / Tube 2000 Units / Box |
| 2N6073A | TO-225 | 500 Units / Box |
| 2N6073AG | TO-225 (Pb-Free) | |
| 2N6073B | TO-225 | |
| 2N6073BG | TO-225 (Pb-Free) | |
| 2N6075A | TO-225 | |
| 2N6075AG | TO-225 (Pb-Free) | |
| 2N6075B | TO-225 | |
| 2N6075BG | TO-225 (Pb-Free) | |

†For information on tape and reel specifications, including part orientation and tape sizes, please refer to our Tape and Reel Packaging Specifications Brochure, BRD8011/D.

2N6071A/B Series

PACKAGE DIMENSIONS

TO-225
CASE 77-09
ISSUE Z

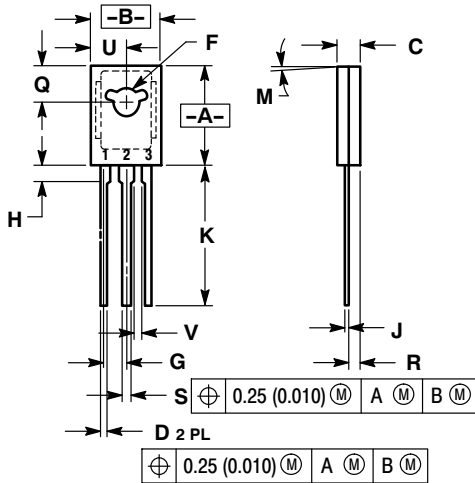

NOTES:

1. DIMENSIONING AND TOLERANCING PER ANSI Y14.5M, 1982.
2. CONTROLLING DIMENSION: INCH.
3. 077-01 THRU -08 OBSOLETE, NEW STANDARD 077-09.

| DIM | INCHES | | MILLIMETERS | |
|-----|-----------|-------|-------------|-------|
| | MIN | MAX | MIN | MAX |
| A | 0.425 | 0.435 | 10.80 | 11.04 |
| B | 0.295 | 0.305 | 7.50 | 7.74 |
| C | 0.095 | 0.105 | 2.42 | 2.66 |
| D | 0.020 | 0.026 | 0.51 | 0.66 |
| F | 0.115 | 0.130 | 2.93 | 3.30 |
| G | 0.094 BSC | | 2.39 BSC | |
| H | 0.050 | 0.095 | 1.27 | 2.41 |
| J | 0.015 | 0.025 | 0.39 | 0.63 |
| K | 0.575 | 0.655 | 14.61 | 16.63 |
| M | 5° TYP | | 5° TYP | |
| Q | 0.148 | 0.158 | 3.76 | 4.01 |
| R | 0.045 | 0.065 | 1.15 | 1.65 |
| S | 0.025 | 0.035 | 0.64 | 0.88 |
| U | 0.145 | 0.155 | 3.69 | 3.93 |
| V | 0.040 | --- | 1.02 | --- |

STYLE 5:

1. MT 1
2. MT 2
3. GATE

ON Semiconductor and are registered trademarks of Semiconductor Components Industries, LLC (SCILLC). SCILLC reserves the right to make changes without further notice to any products herein. SCILLC makes no warranty, representation or guarantee regarding the suitability of its products for any particular purpose, nor does SCILLC assume any liability arising out of the application or use of any product or circuit, and specifically disclaims any and all liability, including without limitation special, consequential or incidental damages. "Typical" parameters which may be provided in SCILLC data sheets and/or specifications can and do vary in different applications and actual performance may vary over time. All operating parameters, including "Typicals" must be validated for each customer application by customer's technical experts. SCILLC does not convey any license under its patent rights nor the rights of others. SCILLC products are not designed, intended, or authorized for use as components in systems intended for surgical implant into the body, or other applications intended to support or sustain life, or for any other application in which the failure of the SCILLC product could create a situation where personal injury or death may occur. Should Buyer purchase or use SCILLC products for any such unintended or unauthorized application, Buyer shall indemnify and hold SCILLC and its officers, employees, subsidiaries, affiliates, and distributors harmless against all claims, costs, damages, and expenses, and reasonable attorney fees arising out of, directly or indirectly, any claim of personal injury or death associated with such unintended or unauthorized use, even if such claim alleges that SCILLC was negligent regarding the design or manufacture of the part. SCILLC is an Equal Opportunity/Affirmative Action Employer. This literature is subject to all applicable copyright laws and is not for resale in any manner.

PUBLICATION ORDERING INFORMATION

LITERATURE FULFILLMENT:

Literature Distribution Center for ON Semiconductor
P.O. Box 5163, Denver, Colorado 80217 USA
Phone: 303-675-2175 or 800-344-3860 Toll Free USA/Canada
Fax: 303-675-2176 or 800-344-3867 Toll Free USA/Canada
Email: orderlit@onsemi.com

N. American Technical Support: 800-282-9855 Toll Free
USA/Canada
Europe, Middle East and Africa Technical Support:
Phone: 421 33 790 2910
Japan Customer Focus Center
Phone: 81-3-5773-3850

ON Semiconductor Website: www.onsemi.com

Order Literature: <http://www.onsemi.com/orderlit>

For additional information, please contact your local Sales Representative