

Description

The TL431 and TL432 are three terminal adjustable shunt regulators offering excellent temperature stability and output current handling capability up to 100mA. The output voltage may be set to any chosen voltage between 2.5 and 36 volts by selection of two external divider resistors.

The devices can be used as a replacement for zener diodes in many applications requiring an improvement in zener performance. Diodes' TL431 has the same electrical specifications as the industry standard '431 and is available in 2 grades with initial tolerances of 1% and 0.5% for the A and B grades respectively.

Features

- Temperature range -40 to +125°C
- Reference Voltage Tolerance at 25°C
 - TL431A: 2.495V ± 1.0%
 - TL431B: 2.495V ± 0.5%
- Low Output Noise
- 0.2Ω Typical Output Impedance
- Sink Current Capability: 1mA to 100mA
- Adjustable Output Voltage: V_{REF} to 36V
- All devices are:
 - Totally Lead-Free & Fully RoHS compliant (Notes 1 & 2)
 - Halogen and Antimony Free. "Green" Device (Note 3)

Applications

- Opto-Coupler Linearisers
- Shunt Regulators
- Improved Zener
- Variable Reference

Notes: 1. No purposely added lead. Fully EU Directive 2002/95/EC (RoHS) & 2011/65/EU (RoHS 2) compliant.
 2. See http://www.diodes.com/quality/lead_free.html for more information about Diodes Incorporated's definitions of Halogen and Antimony free, "Green" and Lead-Free.
 3. Halogen and Antimony free "Green" products are defined as those which contain <900ppm bromine, <900ppm chlorine (<1500ppm total Br + Cl) and <1000ppm antimony compounds.

Pin Assignments

TL431

(Top View)

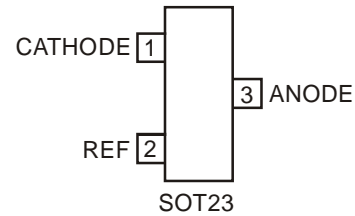

SOT23

(Top View)

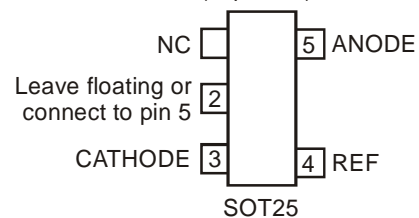

SOT25

(Top View)

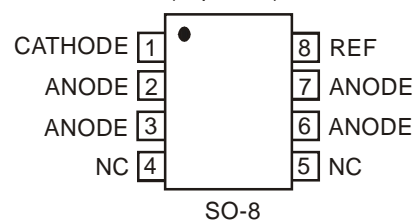

SO-8

SO-8 is a future product

TL432

(Top View)

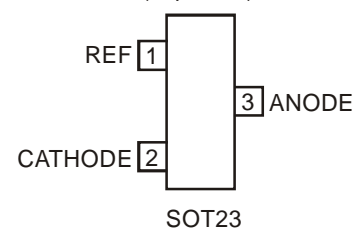

SOT23

Absolute Maximum Ratings (Note 4)

Symbol	Parameter		Rating	Unit
V_{KA}	Cathode Voltage		40	V
I_{KA}	Continuous Cathode Current		150	mA
I_{REF}	Reference Input Current		-0.050 to +10	mA
T_J	Operating Junction Temperature		+150	°C
T_{ST}	Storage Temperature		-55 to +150	°C
P_D	Power Dissipation (Notes 5, 6)	SOT23	330	mW
		SOT25	500	
		SO-8*	700	

- Notes:
- 4. Operation above the absolute maximum rating may cause device failure. Operation at the absolute maximum ratings, for extended periods, may reduce device reliability. Unless otherwise stated voltages specified are relative to the ANODE pin.
 - 5. $T_J, MAX = 150^\circ C$.
 - 6. Ratings apply to ambient temperature at $25^\circ C$.

Recommended Operating Conditions

Symbol	Parameter	Min	Max	Unit
V_{KA}	Cathode Voltage	V_{REF}	36	V
I_{KA}	Cathode Current	1	100	mA
T_A	Operating Ambient Temperature	-40	+125	°C

Electrical Characteristics (T_A = +25°C, unless otherwise noted)

Symbol	Parameter	Test Conditions	Min	Typ.	Max	Unit
V _{REF}	Reference voltage	V _{KA} = V _{REF} , I _{KA} = 10mA	TL431A 2.470	2.495	2.520	V
			TL431B 2.482	2.495	2.507	
V _{DEV}	Deviation of reference voltage over full temperature range (Note 5)	V _{KA} = V _{REF} , I _{KA} = 10mA	T _A = 0 to 70°C	6	16	mV
			T _A = -40 to +85°C	14	34	
			T _A = -40 to +125°C	14	34	
$\frac{\Delta V_{REF}}{\Delta V_{KA}}$	Ratio of the change in reference voltage to the change in cathode voltage	I _{KA} = 10mA	V _{KA} = 10V to V _{REF}	-1.4	-2.7	mV/V
			V _{KA} = 36V to 10V	-1	-2	
I _{REF}	Reference input current	I _{KA} = 10mA, R1 = 10KΩ, R2 = ∞		1	4	μA
ΔI _{REF}	I _{REF} deviation over full temperature range (Note 7)	I _{KA} = 10mA, R1 = 10KΩ, R2 = ∞	T _A = 0 to 70°C	0.8	1.2	μA
			T _A = -40 to +85°C	0.8	2.5	
			T _A = -40 to +125°C	0.8	2.5	
I _{KA(MIN)}	Minimum cathode current for regulation	V _{KA} = V _{REF}		0.4	0.7	mA
I _{KA(OFF)}	Off-state current	V _{KA} = 36V, V _{REF} = 0V		0.05	0.5	μA
Z _{KA}	Dynamic output impedance (Note 8)	V _{KA} = V _{REF} , f = 0Hz		0.2	0.5	Ω
θ _{JA}	Thermal Resistance Junction to Ambient	SOT23		380		°C/W
		SOT25		250		
		SO-8*		70		

Notes: 7. Deviation of V_{DEV}, and ΔI_{REF} are defined as the maximum variation of the values over the full temperature range.

The average temperature coefficient of the reference input voltage αV_{REF} is defined as:

$$|\alpha V_{REF}| = \left(\frac{V_{DEV}}{V_{REF} @ 25^{\circ}C} \right) \times 10^6 \text{ ppm/}^{\circ}C$$

Where:

T₂ - T₁ = full temperature change.

αV_{REF} can be positive or negative depending on whether the slope is positive or negative.

Notes: 8. The dynamic output impedance, R_Z, is defined as:

$$|Z_{KA}| = \frac{\Delta V_{KA}}{\Delta I_{KA}}$$

When the device is programmed with two external resistors R1 and R2, the dynamic output impedance of the overall circuit, is defined as:

$$|Z'| = \frac{\Delta V}{\Delta I} \approx |Z_{KA}| \left(1 + \frac{R1}{R2} \right)$$

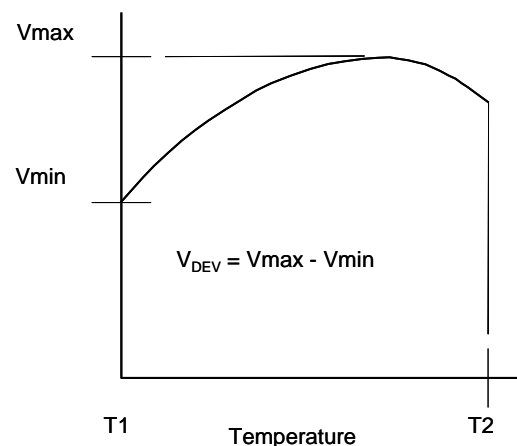

Test Circuits

Figure 1. Test circuit for $V_{KA} = V_{REF}$

Figure 2. Test circuit for $V_{KA} > V_{REF}$

Figure 3. Test circuit for I_{OFF}

Typical Performance Characteristics

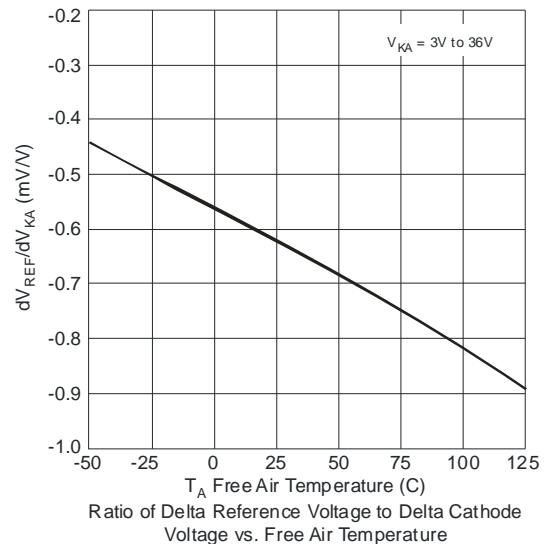
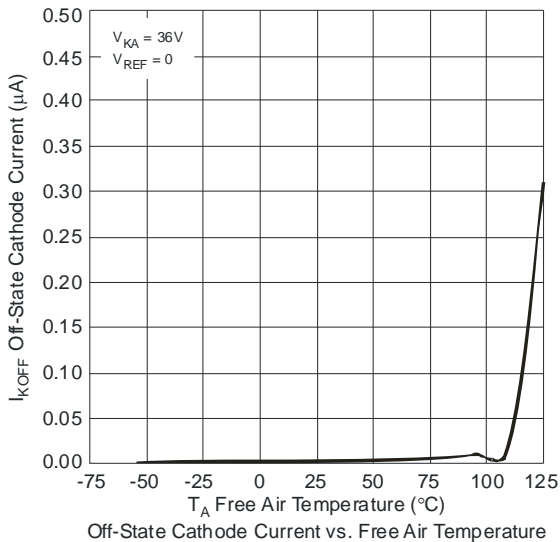
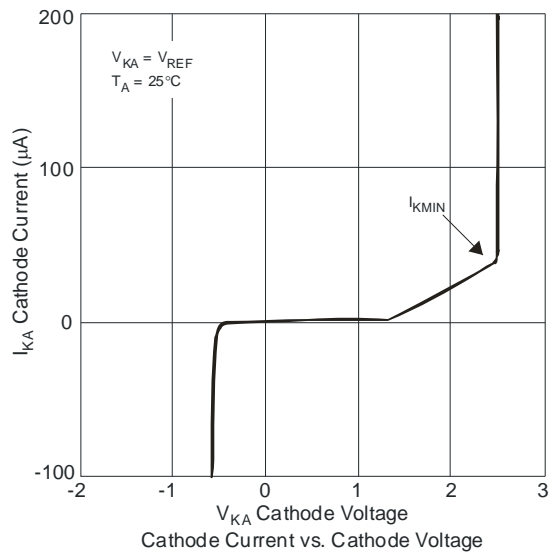
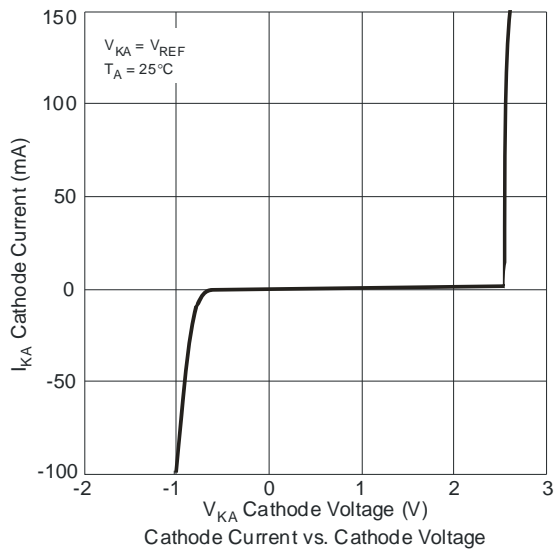
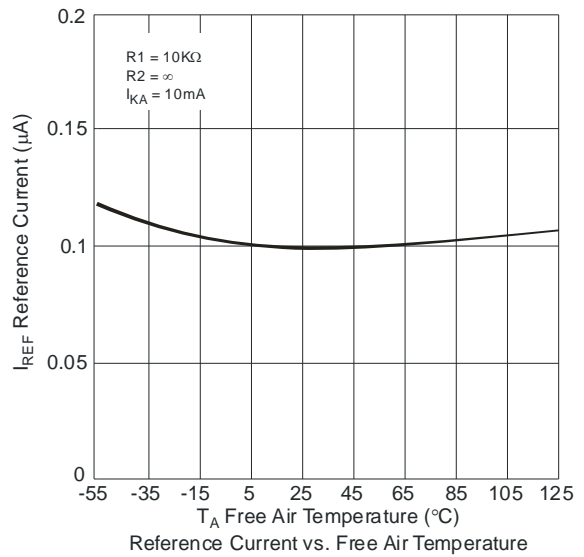
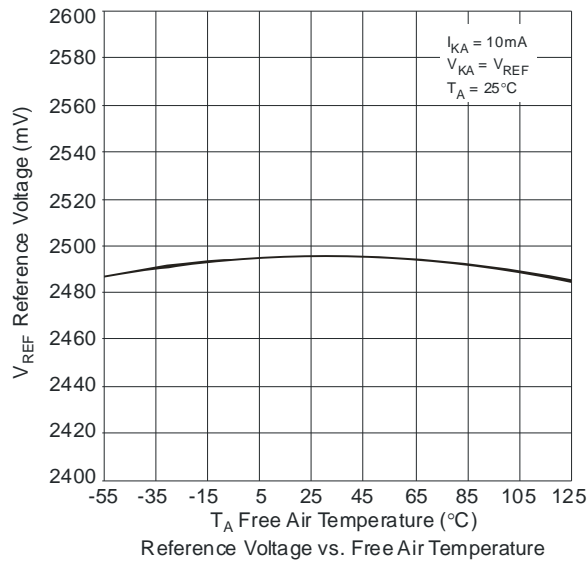

Typical Performance Characteristics (cont.)

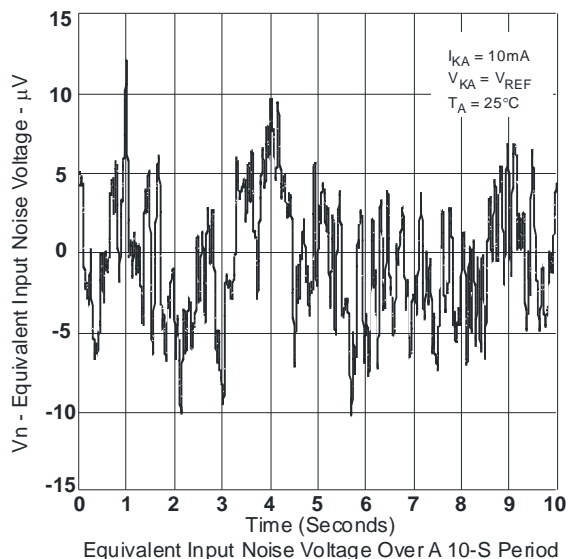
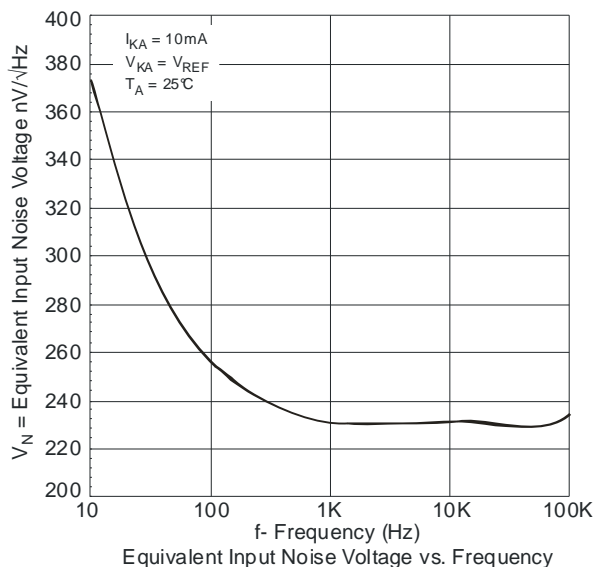
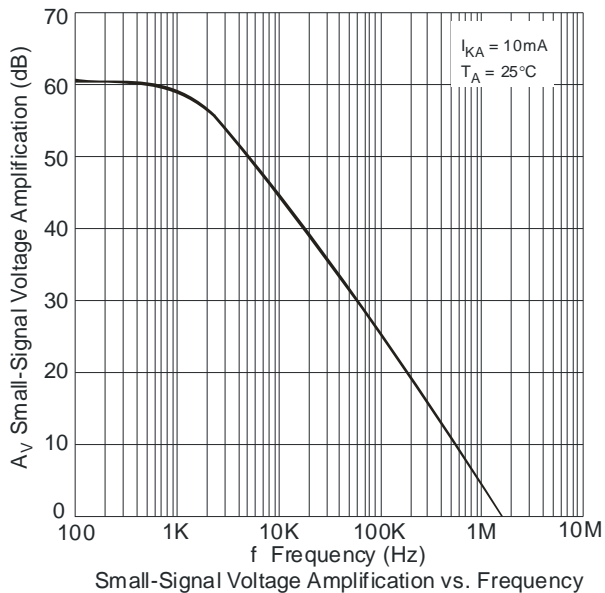
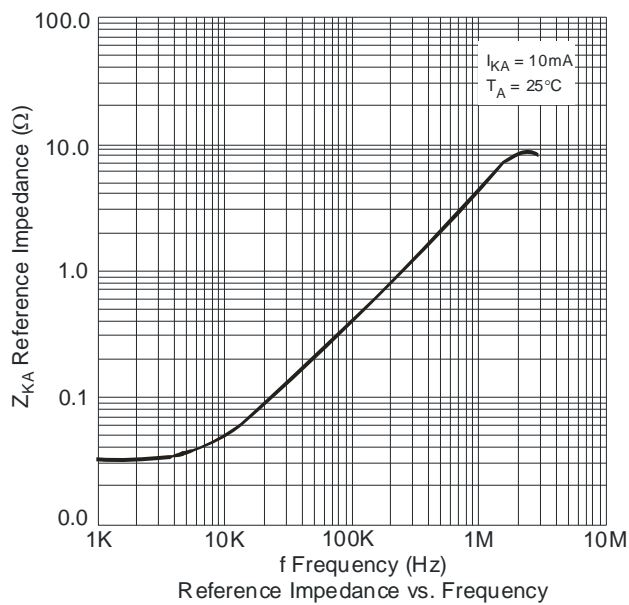

Figure 4. Test circuit for noise input voltage

Typical Performance Characteristics (cont.)



Test circuit for voltage amplification



Test circuit for reference impedance

Typical Performance Characteristics (cont.)

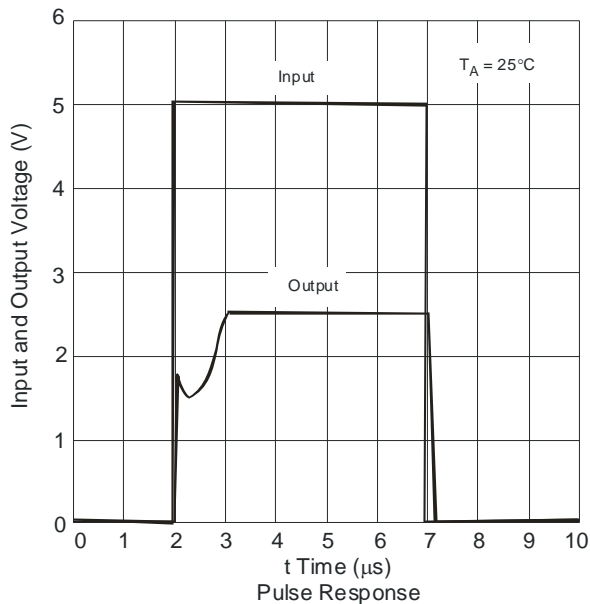

Test Circuit for Pulse Response

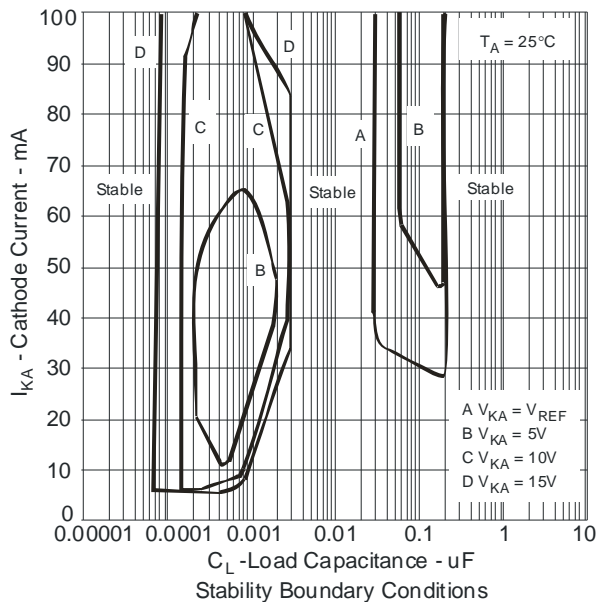

Test Circuit for Curve A

Test circuit for curves B, C, D

Test Circuit for Curves B, C, D

The device is stable under all conditions with a load capacitance not exceeding 50pF. The device is stable under all conditions with a load capacitance between 5nF and 20nF. The device is stable under all conditions with a load capacitance exceeding 300nF. With a cathode current not exceeding 5mA, the device is stable with any load capacitance.

Applications Information

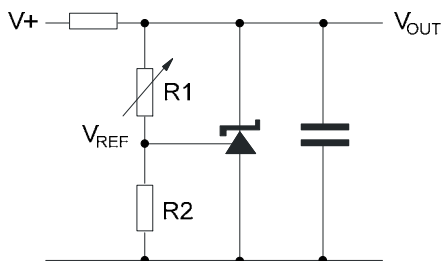

$$V_{OUT} = \left(1 + \frac{R1}{R2}\right)V_{REF}$$

Shunt Regulator

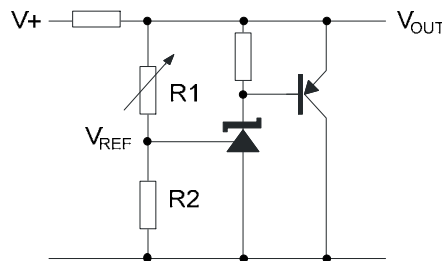

$$V_{OUT} = \left(1 + \frac{R1}{R2}\right)V_{REF}$$

Higher Current Shunt Regulator

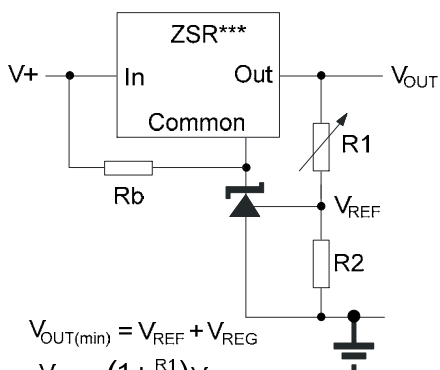

$$V_{OUT(min)} = V_{REF} + V_{REG}$$

$$V_{OUT} = \left(1 + \frac{R1}{R2}\right)V_{REF}$$

Rb - Optional to provide minimum cathode current

Output Control of a Three Terminal Fixed Regulator

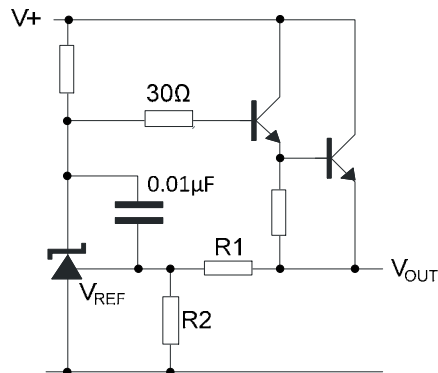

$$V_{OUT} = \left(1 + \frac{R1}{R2}\right)V_{REF}$$

Series Regulator

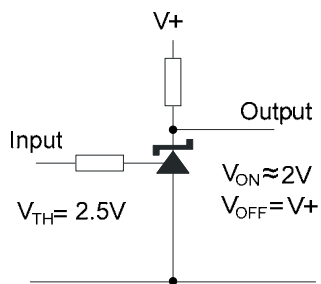

Single Supply Comparator with Temperature Compensated Threshold

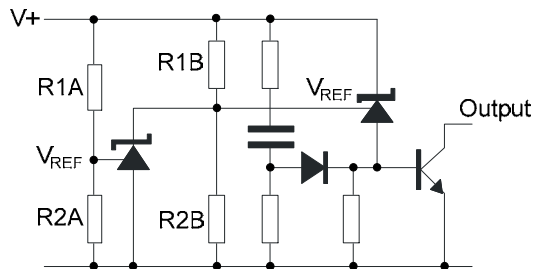





$$\text{Low Limit} = \left(1 + \frac{R1B}{R2B}\right)V_{REF}$$

$$\text{High Limit} = \left(1 + \frac{R1A}{R2A}\right)V_{REF}$$

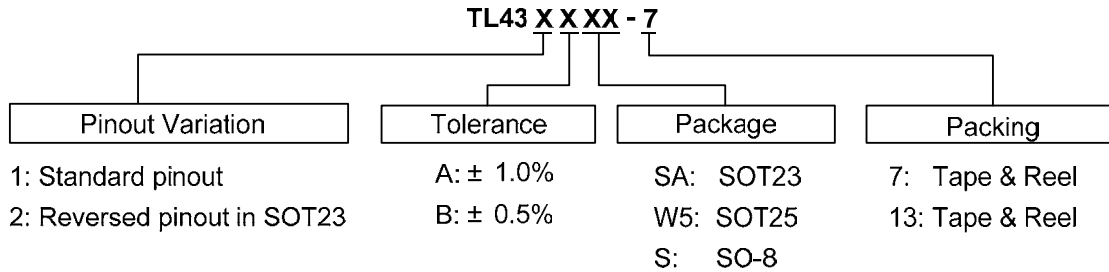
Over Voltage / Under Voltage Protection Circuit

Ordering Information



Device	Package Code	Packaging (Note 9)	7" Tape and Reel		Ammo Box	
			Quantity	Part Number Suffix	Quantity	Part Number Suffix
 TL431A(B)SA-7	SA	SOT23	3000/Tape & Reel	-7	NA	NA
 TL431A(B)W5-7	W5	SOT25	3000/Tape & Reel	-7	NA	NA
 TL431A(B)S-13*	S	SO-8*	2500/Tape & Reel	-13	NA	NA
 TL432A(B)SA-7	SA	SOT23	3000/Tape & Reel	-7	NA	NA

* Suffix "B" denotes TL431B device.

Notes: 9. Pad layout as shown on Diodes Inc. suggested pad layout document AP02001, which can be found on our website at <http://www.diodes.com/datasheets/ap02001.pdf>.

Marking Information

(1) SOT23

(Top View)

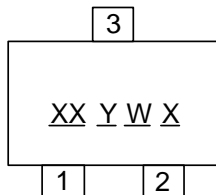

XX : Identification code
Y : Year 0~9
W : Week : A~Z : 1~26 week;
 a~z : 27~52 week; z represents
 52 and 53 week
X : A~Z : Green

Device	Package	Identification Code
TL431ASA	SOT23	AA
TL431BSA	SOT23	AB
TL432ASA	SOT23	BA
TL432BSA	SOT23	BB

(2) SOT25

(Top View)

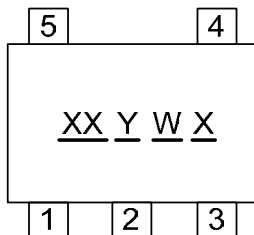

XX : Identification code
Y : Year 0~9
W : Week : A~Z : 1~26 week;
 a~z : 27~52 week; z represents
 52 and 53 week
X : A~Z : Green

Device	Package	Identification Code
TL431AW5	SOT25	AA
TL431BW5	SOT25	AB

(3) SO-8*

(Top View)

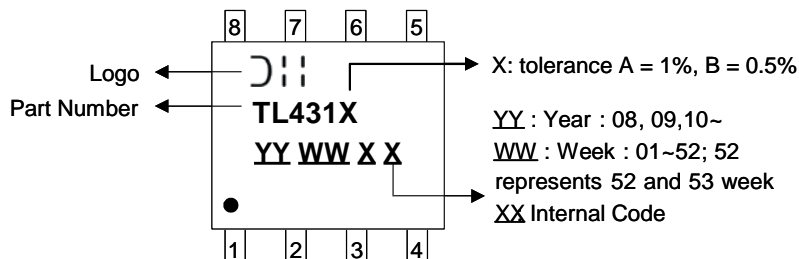

X: tolerance A = 1%, B = 0.5%
YY : Year : 08, 09, 10~
WW : Week : 01~52; 52
 represents 52 and 53 week
XX Internal Code

Package Outline Dimensions (All Dimensions in mm)

(1) Package type: SOT25

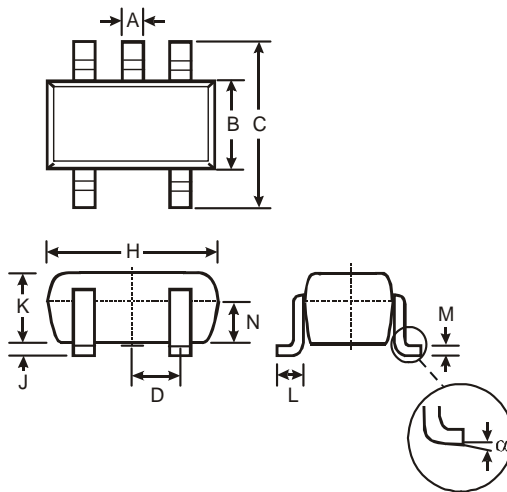

SOT25			
Dim	Min	Max	Typ
A	0.35	0.50	0.38
B	1.50	1.70	1.60
C	2.70	3.00	2.80
D	—	—	0.95
H	2.90	3.10	3.00
J	0.013	0.10	0.05
K	1.00	1.30	1.10
L	0.35	0.55	0.40
M	0.10	0.20	0.15
N	0.70	0.80	0.75
α	0°	8°	—
All Dimensions in mm			

(2) Package Types: SOT23

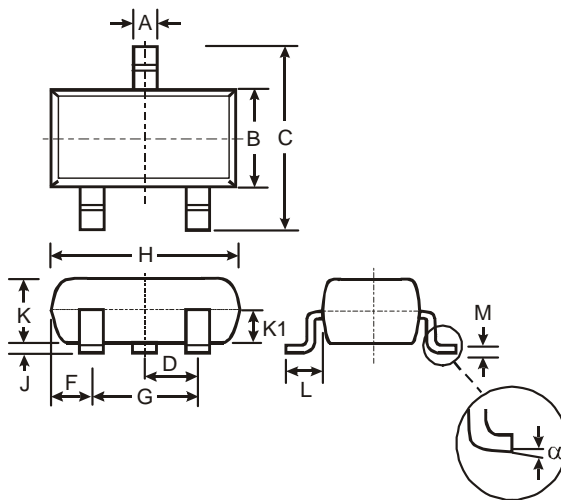

SOT23			
Dim	Min	Max	Typ
A	0.37	0.51	0.40
B	1.20	1.40	1.30
C	2.30	2.50	2.40
D	0.89	1.03	0.915
F	0.45	0.60	0.535
G	1.78	2.05	1.83
H	2.80	3.00	2.90
J	0.013	0.10	0.05
K	0.903	1.10	1.00
K1	-	-	0.400
L	0.45	0.61	0.55
M	0.085	0.18	0.11
α	0°	8°	-
All Dimensions in mm			

Package Outline Dimensions (All Dimensions in mm)

(3) Package Types: SO-8*

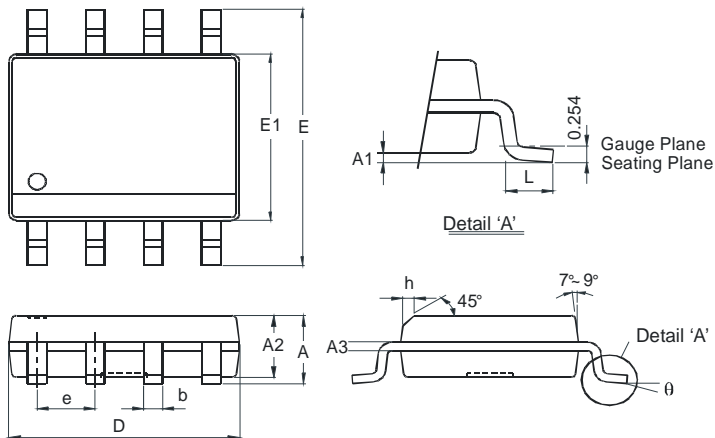

SO-8*		
Dim	Min	Max
A	-	1.75
A1	0.10	0.20
A2	1.30	1.50
A3	0.15	0.25
b	0.3	0.5
D	4.85	4.95
E	5.90	6.10
E1	3.85	3.95
e	1.27 Typ	
h	-	0.35
L	0.62	0.82
θ	0°	8°
All Dimensions in mm		

IMPORTANT NOTICE

DIODES INCORPORATED MAKES NO WARRANTY OF ANY KIND, EXPRESS OR IMPLIED, WITH REGARDS TO THIS DOCUMENT, INCLUDING, BUT NOT LIMITED TO, THE IMPLIED WARRANTIES OF MERCHANTABILITY AND FITNESS FOR A PARTICULAR PURPOSE (AND THEIR EQUIVALENTS UNDER THE LAWS OF ANY JURISDICTION).

Diodes Incorporated and its subsidiaries reserve the right to make modifications, enhancements, improvements, corrections or other changes without further notice to this document and any product described herein. Diodes Incorporated does not assume any liability arising out of the application or use of this document or any product described herein; neither does Diodes Incorporated convey any license under its patent or trademark rights, nor the rights of others. Any Customer or user of this document or products described herein in such applications shall assume all risks of such use and will agree to hold Diodes Incorporated and all the companies whose products are represented on Diodes Incorporated website, harmless against all damages.

Diodes Incorporated does not warrant or accept any liability whatsoever in respect of any products purchased through unauthorized sales channel.

Should Customers purchase or use Diodes Incorporated products for any unintended or unauthorized application, Customers shall indemnify and hold Diodes Incorporated and its representatives harmless against all claims, damages, expenses, and attorney fees arising out of, directly or indirectly, any claim of personal injury or death associated with such unintended or unauthorized application.

Products described herein may be covered by one or more United States, international or foreign patents pending. Product names and markings noted herein may also be covered by one or more United States, international or foreign trademarks.

LIFE SUPPORT

Diodes Incorporated products are specifically not authorized for use as critical components in life support devices or systems without the express written approval of the Chief Executive Officer of Diodes Incorporated. As used herein:

A. Life support devices or systems are devices or systems which:

1. are intended to implant into the body, or
2. support or sustain life and whose failure to perform when properly used in accordance with instructions for use provided in the labeling can be reasonably expected to result in significant injury to the user.

B. A critical component is any component in a life support device or system whose failure to perform can be reasonably expected to cause the failure of the life support device or to affect its safety or effectiveness.

Customers represent that they have all necessary expertise in the safety and regulatory ramifications of their life support devices or systems, and acknowledge and agree that they are solely responsible for all legal, regulatory and safety-related requirements concerning their products and any use of Diodes Incorporated products in such safety-critical, life support devices or systems, notwithstanding any devices- or systems-related information or support that may be provided by Diodes Incorporated. Further, Customers must fully indemnify Diodes Incorporated and its representatives against any damages arising out of the use of Diodes Incorporated products in such safety-critical, life support devices or systems.

Copyright © 2012, Diodes Incorporated

www.diodes.com