

2N5210/MMBT5210

NPN General Purpose Amplifier

This device is designed for low noise, high gain, general purpose amplifier applications at collector currents from 1µA to 50 mA.

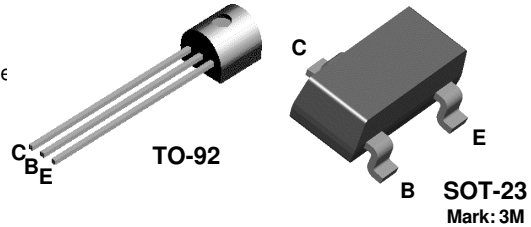

Absolute Maximum Ratings*

TA = 25°C unless otherwise noted

Symbol	Parameter	Value	Units
V _{CEO}	Collector-Emitter Voltage	50	V
V _{CBO}	Collector-Base Voltage	50	V
V _{EBO}	Emitter-Base Voltage	4.5	V
I _C	Collector Current - Continuous	100	mA
T _J , T _{stg}	Operating and Storage Junction Temperature Range	-55 to +150	°C

* These ratings are limiting values above which the serviceability of any semiconductor device may be impaired.

NOTES:

- 1) These ratings are based on a maximum junction temperature of 150 degrees C.
- 2) These are steady state limits. The factory should be consulted on applications involving pulsed or low duty cycle operations.

Thermal Characteristics

TA = 25°C unless otherwise noted

Symbol	Characteristic	Max.		Units
		2N5210	MMBT5210	
P _D	Total Device Dissipation	625	350	mW
	Derate above 25°C	5.0	2.8	mW/°C
R _{θJC}	Thermal Resistance, Junction to Case	83.3		°C/W
R _{θJA}	Thermal Resistance, Junction to Ambient	200	357	°C/W

NPN General Purpose Amplifier (continued)

2N5210/MMBT5210

Electrical Characteristics

TA = 25 °C unless otherwise noted

Symbol	Parameter	Test Conditions	Min	Max	Units
--------	-----------	-----------------	-----	-----	-------

OFF CHARACTERISTICS

$V_{(BR)CEO}$	Collector-Emitter Breakdown Voltage	$I_C = 1.0 \text{ mA}, I_B = 0$	50		V
$V_{(BR)CBO}$	Collector-Base Breakdown Voltage	$I_C = 0.1 \text{ mA}, I_E = 0$	50		V
I_{CBO}	Collector Cutoff Current	$V_{CB} = 35 \text{ V}, I_E = 0$		50	nA
I_{EBO}	Emitter Cutoff Current	$V_{EB} = 3.0 \text{ V}, I_C = 0$		50	nA

ON CHARACTERISTICS

h_{FE}	DC Current Gain	$I_C = 100 \mu\text{A}, V_{CE} = 5.0 \text{ V}$ $I_C = 1.0 \text{ mA}, V_{CE} = 5.0 \text{ V}$ $I_C = 10 \text{ mA}, V_{CE} = 5.0 \text{ V}^*$	200 250 250	600	
$V_{CE(sat)}$	Collector-Emitter Saturation Voltage	$I_C = 10 \text{ mA}, I_B = 1.0 \text{ mA}$		0.7	V
$V_{BE(on)}$	Base-Emitter On Voltage	$I_C = 1.0 \text{ mA}, V_{CE} = 5.0 \text{ V}$		0.85	V

SMALL SIGNAL CHARACTERISTICS

f_T	Current Gain - Bandwidth Product	$I_C = 500 \mu\text{A}, V_{CE} = 5.0 \text{ V},$ $f = 20 \text{ MHz}$	30		MHz
C_{cb}	Collector-Base Capacitance	$V_{CB} = 5.0 \text{ V}, I_E = 0, f = 100 \text{ kHz}$		4.0	pF
h_{fe}	Small-Signal Current Gain	$I_C = 1.0 \text{ mA}, V_{CE} = 5.0 \text{ V},$ $f = 1.0 \text{ kHz}$	250	900	
NF	Noise Figure	$I_C = 20 \mu\text{A}, V_{CE} = 5.0 \text{ V},$ $R_S = 22 \text{ k}\Omega, f = 10 \text{ Hz to } 15.7 \text{ kHz}$ $I_C = 20 \mu\text{A}, V_{CE} = 5.0 \text{ V},$ $R_S = 10 \text{ k}\Omega, f = 1.0 \text{ kHz}$		2.0 3.0	dB dB

*Pulse Test: Pulse Width $\leq 300 \mu\text{s}$, Duty Cycle $\leq 2.0\%$

NPN General Purpose Amplifier

(continued)

2N5210/MMBT5210

Typical Characteristics

Typical Pulsed Current Gain vs Collector Current

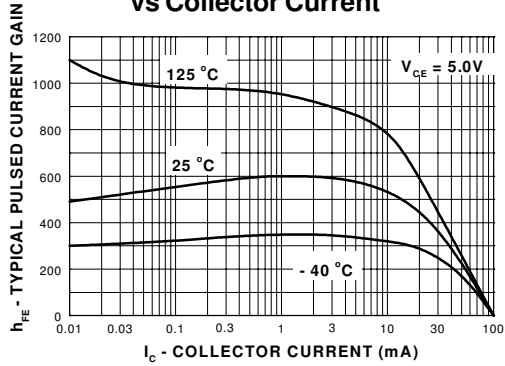

Collector-Emitter Saturation Voltage vs Collector Current

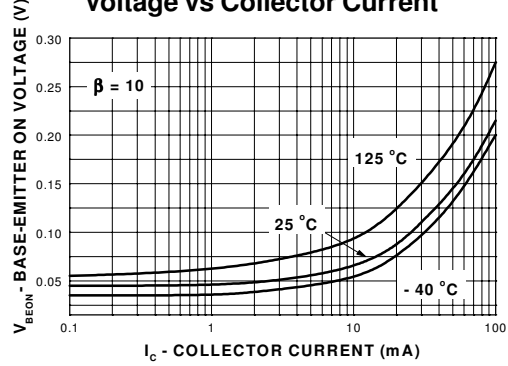

Base-Emitter Saturation Voltage vs Collector Current

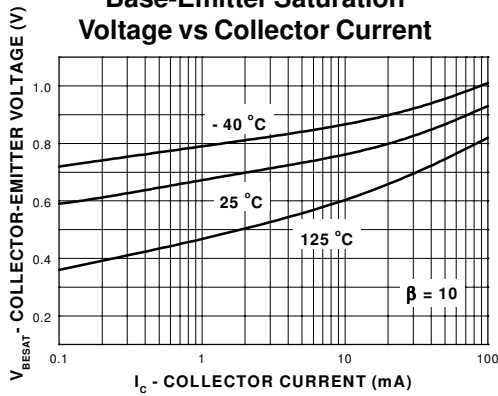

Base-Emitter ON Voltage vs Collector Current

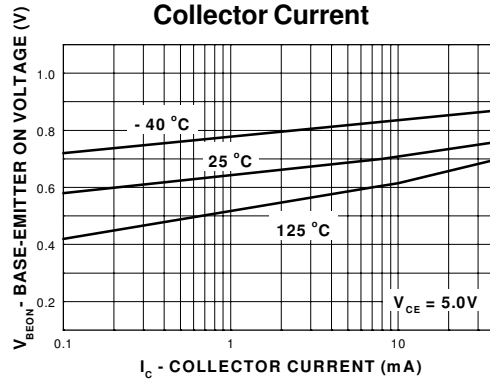

Collector-Cutoff Current vs Ambient Temperature

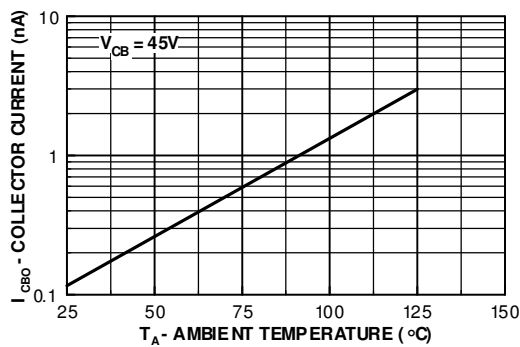

NPN General Purpose Amplifier
(continued)

Typical Characteristics (continued)

Input and Output Capacitance vs Reverse Bias Voltage

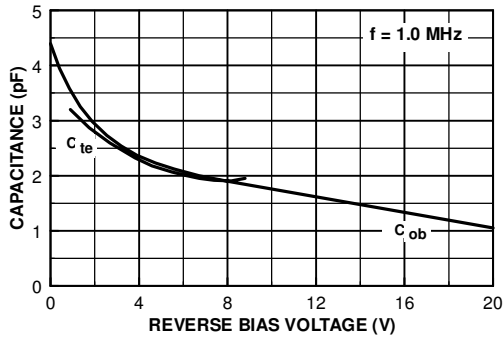

Contours of Constant Gain Bandwidth Product (f_T)

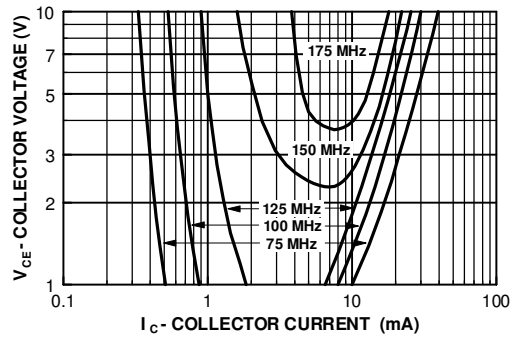

Normalized Collector-Cutoff Current vs Ambient Temperature

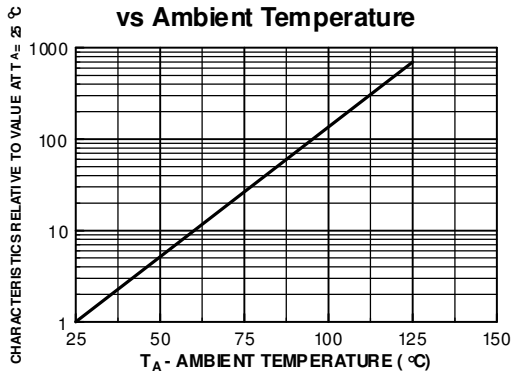

Wideband Noise Frequency vs Source Resistance

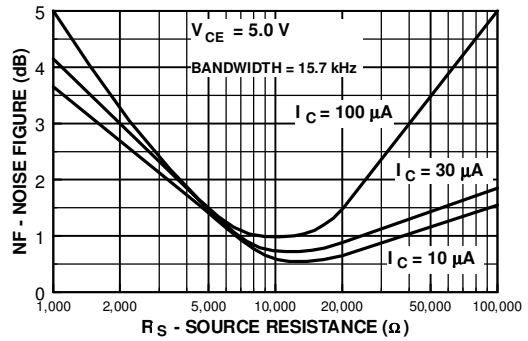

Noise Figure vs Frequency

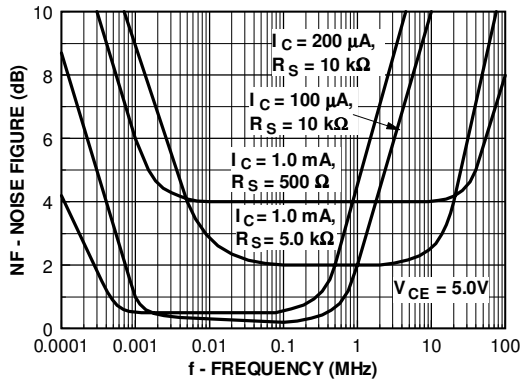

Base-Emitter Saturation Voltage vs Collector Current

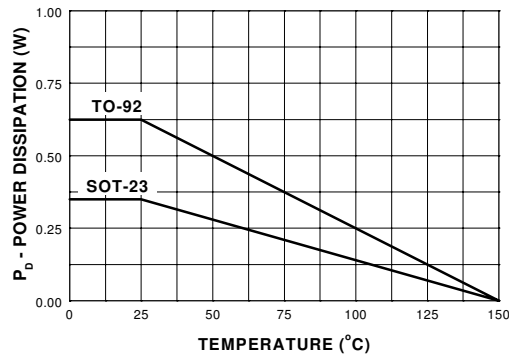

Typical Characteristics (continued)

Contours of Constant
Narrow Band Noise Figure

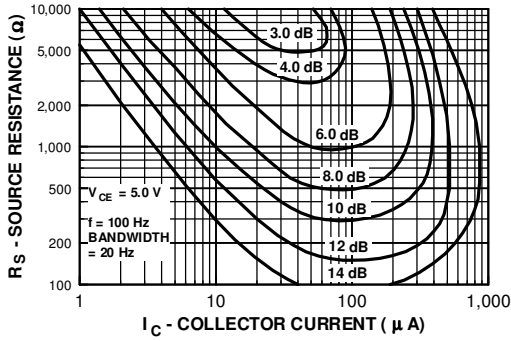

Contours of Constant
Narrow Band Noise Figure

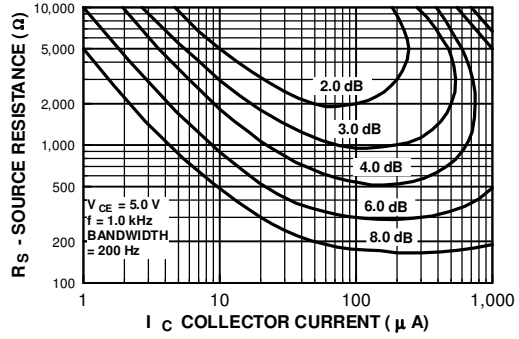

Contours of Constant
Narrow Band Noise Figure

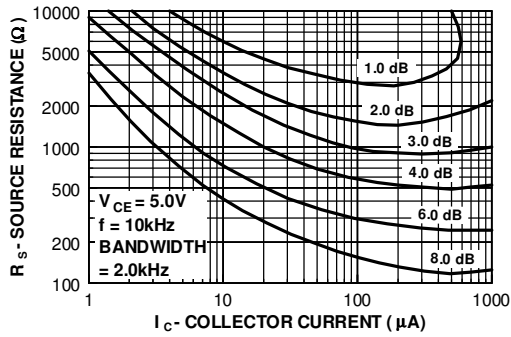

Contours of Constant
Narrow Band Noise Figure

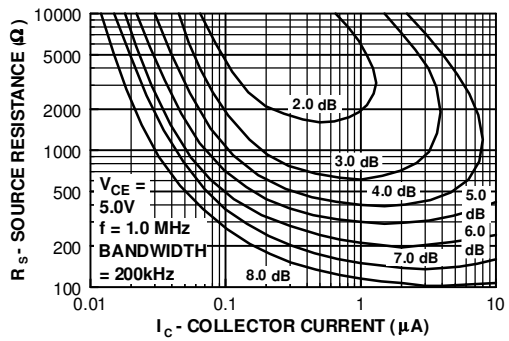

Typical Common Emitter Characteristics (f = 1.0 kHz)

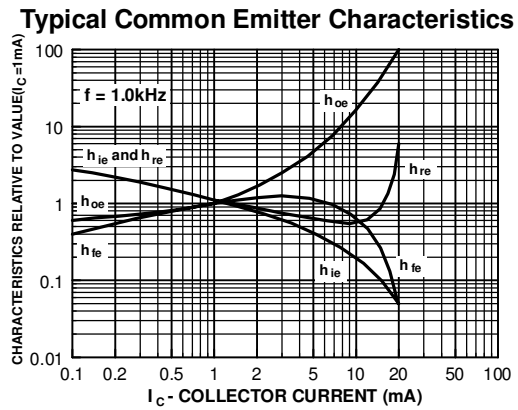
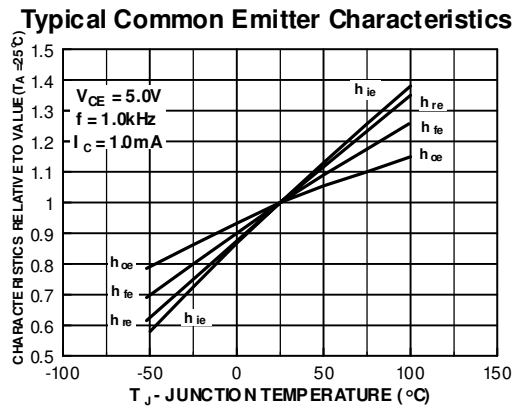
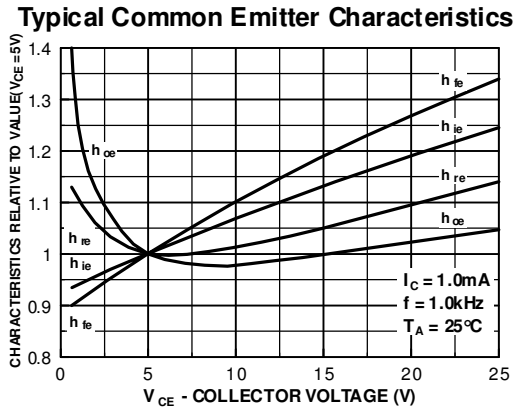

TRADEMARKS

The following are registered and unregistered trademarks Fairchild Semiconductor owns or is authorized to use and is not intended to be an exhaustive list of all such trademarks.

ACE _x [™]	FAST [®]	OPTOLOGIC [™]	SMART START [™]	VCX [™]
Bottomless [™]	FAST _r [™]	OPTOPLANAR [™]	STAR*POWER [™]	
CoolFET [™]	FRFET [™]	PACMAN [™]	Stealth [™]	
CROSSVOLT [™]	GlobalOptoisolator [™]	POP [™]	SuperSOT [™] -3	
DenseTrench [™]	GTO [™]	Power247 [™]	SuperSOT [™] -6	
DOMET [™]	HiSeC [™]	PowerTrench [®]	SuperSOT [™] -8	
EcoSPARK [™]	ISOPLANAR [™]	QFET [™]	SyncFET [™]	
E ² CMOS [™]	LittleFET [™]	QS [™]	TinyLogic [™]	
EnSigna [™]	MicroFET [™]	QT Optoelectronics [™]	TruTranslation [™]	
FACT [™]	MicroPak [™]	Quiet Series [™]	UHC [™]	
FACT Quiet Series [™]	MICROWIRE [™]	SILENT SWITCHER [®]	UltraFET [®]	

STAR*POWER is used under license

DISCLAIMER

FAIRCHILD SEMICONDUCTOR RESERVES THE RIGHT TO MAKE CHANGES WITHOUT FURTHER NOTICE TO ANY PRODUCTS HEREIN TO IMPROVE RELIABILITY, FUNCTION OR DESIGN. FAIRCHILD DOES NOT ASSUME ANY LIABILITY ARISING OUT OF THE APPLICATION OR USE OF ANY PRODUCT OR CIRCUIT DESCRIBED HEREIN; NEITHER DOES IT CONVEY ANY LICENSE UNDER ITS PATENT RIGHTS, NOR THE RIGHTS OF OTHERS.

LIFE SUPPORT POLICY

FAIRCHILD'S PRODUCTS ARE NOT AUTHORIZED FOR USE AS CRITICAL COMPONENTS IN LIFE SUPPORT DEVICES OR SYSTEMS WITHOUT THE EXPRESS WRITTEN APPROVAL OF FAIRCHILD SEMICONDUCTOR CORPORATION.

As used herein:

1. Life support devices or systems are devices or systems which, (a) are intended for surgical implant into the body, or (b) support or sustain life, or (c) whose failure to perform when properly used in accordance with instructions for use provided in the labeling, can be reasonably expected to result in significant injury to the user.
2. A critical component is any component of a life support device or system whose failure to perform can be reasonably expected to cause the failure of the life support device or system, or to affect its safety or effectiveness.

PRODUCT STATUS DEFINITIONS

Definition of Terms

Datasheet Identification	Product Status	Definition
Advance Information	Formative or In Design	This datasheet contains the design specifications for product development. Specifications may change in any manner without notice.
Preliminary	First Production	This datasheet contains preliminary data, and supplementary data will be published at a later date. Fairchild Semiconductor reserves the right to make changes at any time without notice in order to improve design.
No Identification Needed	Full Production	This datasheet contains final specifications. Fairchild Semiconductor reserves the right to make changes at any time without notice in order to improve design.
Obsolete	Not In Production	This datasheet contains specifications on a product that has been discontinued by Fairchild semiconductor. The datasheet is printed for reference information only.