

**PN200  
PN200A**

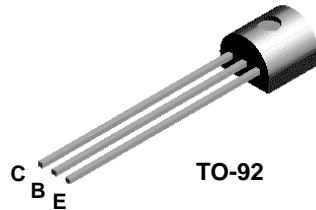

**MMBT200  
MMBT200A**

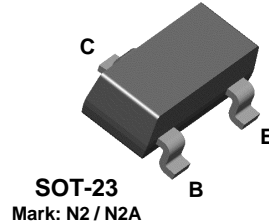

**PNP General Purpose Amplifier**

This device is designed for general purpose amplifier applications at collector currents to 300 mA. Sourced from Process 68.

**Absolute Maximum Ratings\***

TA = 25°C unless otherwise noted

Symbol	Parameter	Value	Units
V <sub>CEO</sub>	Collector-Emitter Voltage	45	V
V <sub>CB0</sub>	Collector-Base Voltage	60	V
V <sub>EBO</sub>	Emitter-Base Voltage	6.0	V
I <sub>C</sub>	Collector Current - Continuous	500	mA
T <sub>J</sub> , T <sub>stg</sub>	Operating and Storage Junction Temperature Range	-55 to +150	°C

\*These ratings are limiting values above which the serviceability of any semiconductor device may be impaired.

**NOTES:**

- 1) These ratings are based on a maximum junction temperature of 150 degrees C.
- 2) These are steady state limits. The factory should be consulted on applications involving pulsed or low duty cycle operations.
- 3) All voltages (V) and currents (A) are negative polarity for PNP transistors.

**Thermal Characteristics**

TA = 25°C unless otherwise noted

Symbol	Characteristic	Max		Units
		PN200 PN200A	*MMBT200 *MMBT200A	
P <sub>D</sub>	Total Device Dissipation Derate above 25°C	625	350	mW
		5.0	2.8	mW/°C
R <sub>θJC</sub>	Thermal Resistance, Junction to Case	83.3		°C/W
R <sub>θJA</sub>	Thermal Resistance, Junction to Ambient	200	357	°C/W

\*Device mounted on FR-4 PCB 1.6" X 1.6" X 0.06."

# PNP General Purpose Amplifier

(continued)

## Electrical Characteristics

TA = 25°C unless otherwise noted

Symbol	Parameter	Test Conditions	Min	Max	Units
<b>OFF CHARACTERISTICS</b>					
$BV_{CBO}$	Collector-Base Breakdown Voltage	$I_C = 10 \mu A, I_B = 0$	60		V
$BV_{CEO}$	Collector-Emitter Breakdown Voltage*	$I_C = 1.0 \text{ mA}, I_E = 0$	45		V
$BV_{EBO}$	Emitter-Base Breakdown Voltage	$I_E = 10 \mu A, I_C = 0$	6.0		V
$I_{CBO}$	Collector Cutoff Current	$V_{CB} = 50 \text{ V}, I_E = 0$		50	nA
$I_{CES}$	Collector Cutoff Current	$V_{CE} = 40 \text{ V}, I_E = 10$		50	nA
$I_{EBO}$	Emitter Cutoff Current	$V_{EB} = 4.0 \text{ V}, I_C = 0$		50	nA

## ON CHARACTERISTICS

$h_{FE}$	DC Current Gain	$I_C = 100 \mu A, V_{CE} = 1.0 \text{ V}$	<b>200</b>	80		
			<b>200A</b>	240		
		$I_C = 10 \text{ mA}, V_{CE} = 1.0 \text{ V}$	<b>200</b>	100	450	
			<b>200A</b>	300	600	
		$I_C = 100 \text{ mA}, V_{CE} = 1.0 \text{ V}^*$	<b>200A</b>	100		
		$I_C = 150 \text{ mA}, V_{CE} = 5.0 \text{ V}^*$	<b>200</b>	100	350	
			<b>200A</b>	100		
$V_{CE(sat)}$	Collector-Emitter Saturation Voltage	$I_C = 10 \text{ mA}, I_B = 1.0 \text{ mA}$		0.2	V	
		$I_C = 200 \text{ mA}, I_B = 20 \text{ mA}^*$		0.4	V	
$V_{BE(sat)}$	Base-Emitter Saturation Voltage	$I_C = 10 \text{ mA}, I_B = 1.0 \text{ mA}$		0.85	V	
		$I_C = 200 \text{ mA}, I_B = 20 \text{ mA}^*$		1.0	V	

## SMALL SIGNAL CHARACTERISTICS

$f_r$	Current Gain - Bandwidth Product	$V_{CE} = 20 \text{ V}, I_C = 20 \text{ mA}$	250		MHz
$C_{obo}$	Output Capacitance	$V_{CB} = 10 \text{ V}, f = 1.0 \text{ MHz}$		6.0	pF
NF	Noise Figure	$I_C = 100 \mu A, V_{CE} = 5.0 \text{ V},$ $R_G = 2.0 \text{ k}\Omega, f = 1.0 \text{ kHz}$			dB
				4.0	dB

\*Pulse Test: Pulse Width  $\leq 300 \mu s$ , Duty Cycle  $\leq 2.0\%$

**NOTE:** All voltages (V) and currents (A) are negative polarity for PNP transistors.

## Typical Characteristics

**Typical Pulsed Current Gain vs Collector Current**

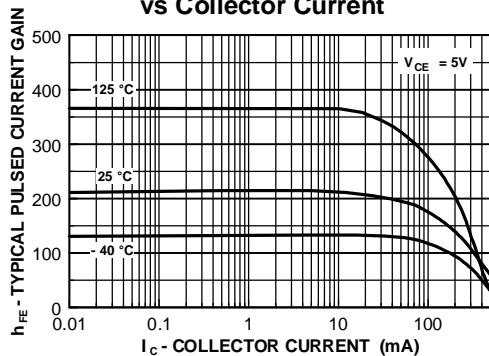

**Collector-Emitter Saturation Voltage vs Collector Current**

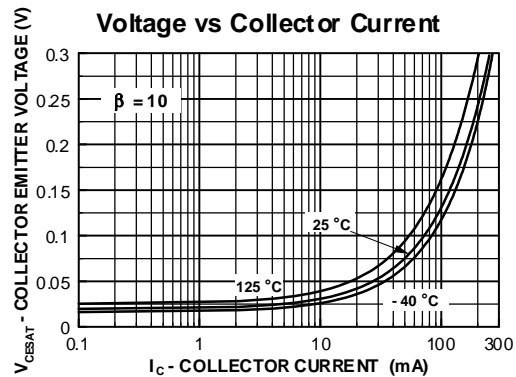

PN200 / MMBT200 / PN200A / MMBT200A

# PNP General Purpose Amplifier

(continued)

PN200 / MMBT200 / PN200A / MMBT200A

## Typical Characteristics (continued)

**Base-Emitter Saturation Voltage vs Collector Current**

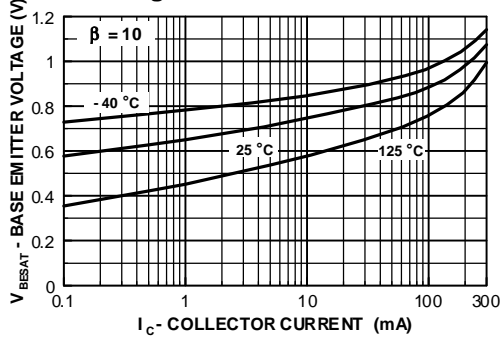

**Base Emitter ON Voltage vs Collector Current**

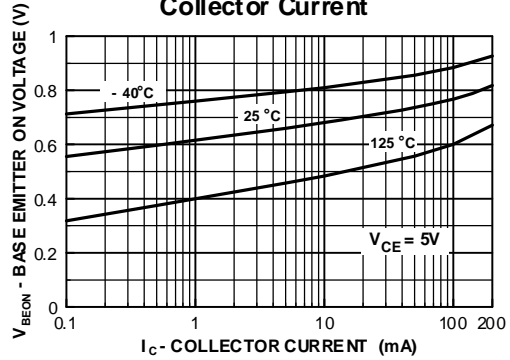

**Collector-Cutoff Current vs Ambient Temperature**

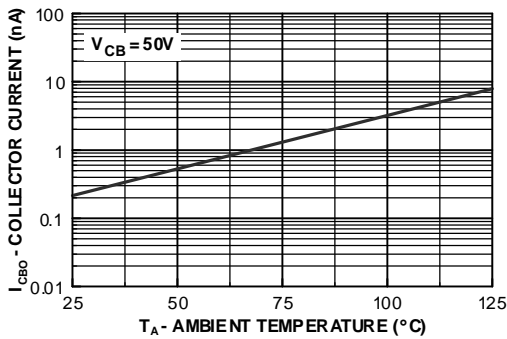

**Collector-Emitter Breakdown Voltage with Resistance Between Emitter-Base**

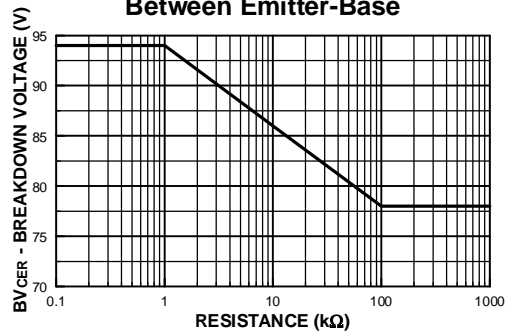

**Collector Saturation Region**

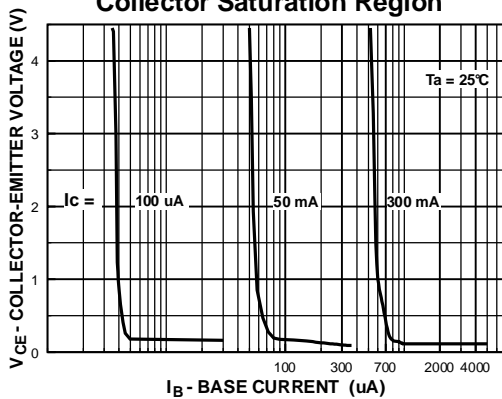

**Input and Output Capacitance vs Reverse Voltage**

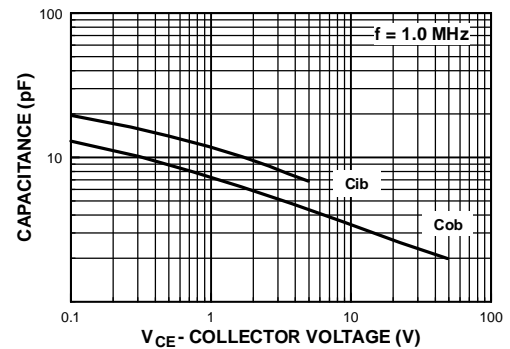

# PNP General Purpose Amplifier

(continued)

## Typical Characteristics (continued)

**Gain Bandwidth Product vs Collector Current**

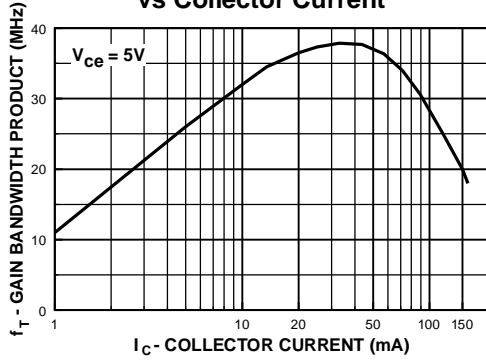

**Switching Times vs Collector Current**

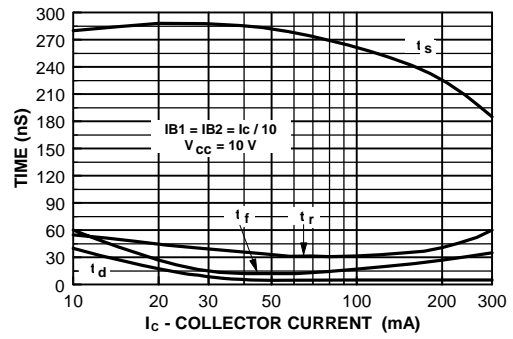

**Power Dissipation vs Ambient Temperature**

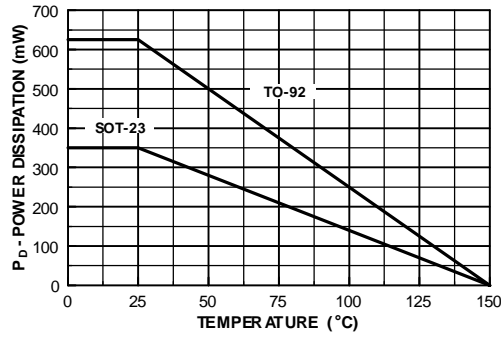

PN200 / MMBT200 / PN200A / MMBT200A

# TO-92 Tape and Reel Data



## TO-92 Packaging Configuration: Figure 1.0

FSCINT Label sample



F63TNR Label sample

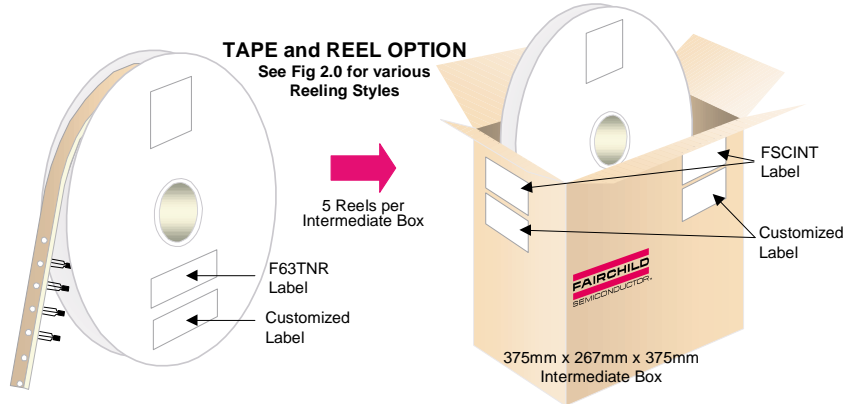

### TO-92 TNR/AMMO PACKING INFORMATION

Packing	Style	Quantity	EOL code
Reel	A	2,000	D26Z
	E	2,000	D27Z
Ammo	M	2,000	D74Z
	P	2,000	D75Z

Unit weight = 0.22 gm  
 Reel weight with components = 1.04 kg  
 Ammo weight with components = 1.02 kg  
 Max quantity per intermediate box = 10,000 units

### AMMO PACK OPTION

See Fig 3.0 for 2 Ammo Pack Options

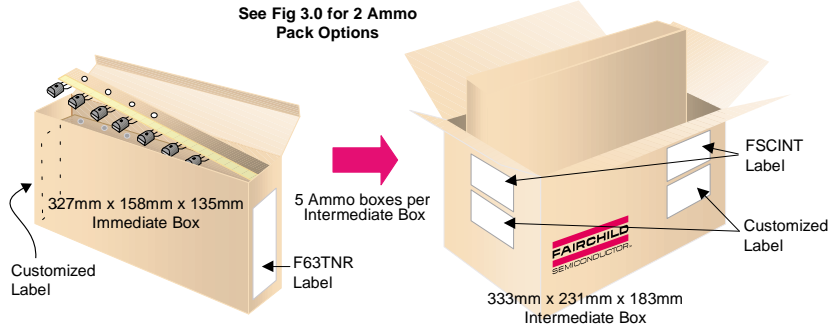

### (TO-92) BULK PACKING INFORMATION

EOL CODE	DESCRIPTION	LEADCLIP DIMENSION	QUANTITY
J18Z	TO-18 OPTION STD	NO LEAD CLIP	2.0 K / BOX
J05Z	TO-5 OPTION STD	NO LEAD CLIP	1.5 K / BOX
NO EOL CODE	TO-92 STANDARD STRAIGHT FOR: PKG 92, 94 (NON PROELECTRON SERIES), 96	NO LEADCLIP	2.0 K / BOX
L34Z	TO-92 STANDARD STRAIGHT FOR: PKG 94 (PROELECTRON SERIES BCXXX, BFXXX, BSRXXX), 97, 98	NO LEADCLIP	2.0 K / BOX

### BULK OPTION

See Bulk Packing Information table

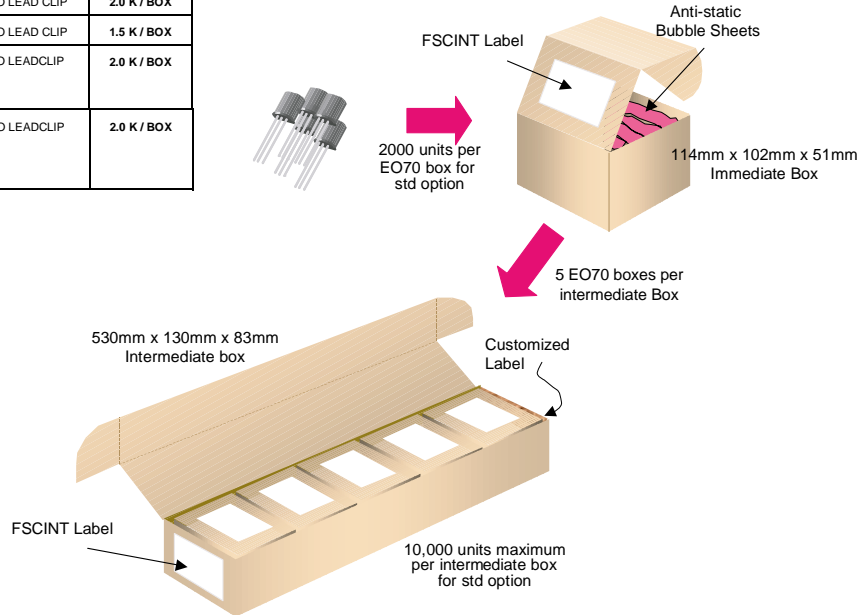

## TO-92 Tape and Reel Data, continued

### TO-92 Reeling Style

Configuration: Figure 2.0

#### Machine Option "A" (H)

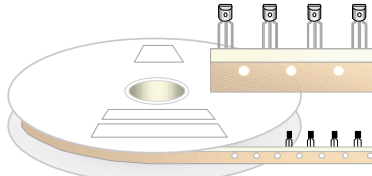

Style "A", D26Z, D70Z (s/h)

#### Machine Option "E" (J)

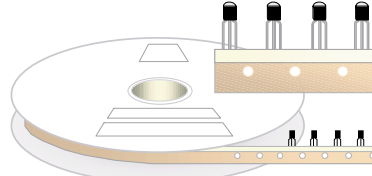

Style "E", D27Z, D71Z (s/h)

### TO-92 Radial Ammo Packaging

Configuration: Figure 3.0

FIRST WIRE OFF IS COLLECTOR  
ADHESIVE TAPE IS ON THE TOP SIDE  
FLAT OF TRANSISTOR IS ON TOP

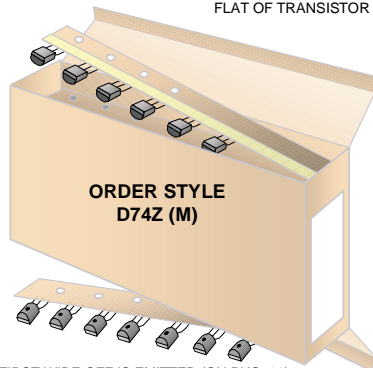

ORDER STYLE  
D74Z (M)

FIRST WIRE OFF IS EMITTER (ON PKG. 92)  
ADHESIVE TAPE IS ON BOTTOM SIDE  
FLAT OF TRANSISTOR IS ON BOTTOM

FIRST WIRE OFF IS EMITTER  
ADHESIVE TAPE IS ON THE TOP SIDE  
FLAT OF TRANSISTOR IS ON BOTTOM

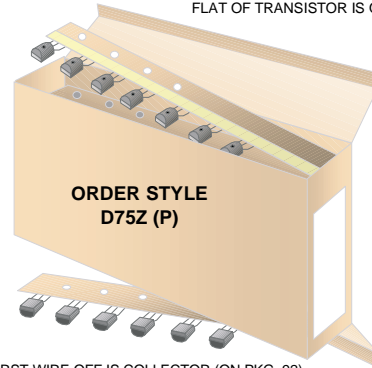

ORDER STYLE  
D75Z (P)

FIRST WIRE OFF IS COLLECTOR (ON PKG. 92)  
ADHESIVE TAPE IS ON BOTTOM SIDE  
FLAT OF TRANSISTOR IS ON TOP

# TO-92 Tape and Reel Data, continued

**TO-92 Tape and Reel Taping  
Dimension Configuration: Figure 4.0**

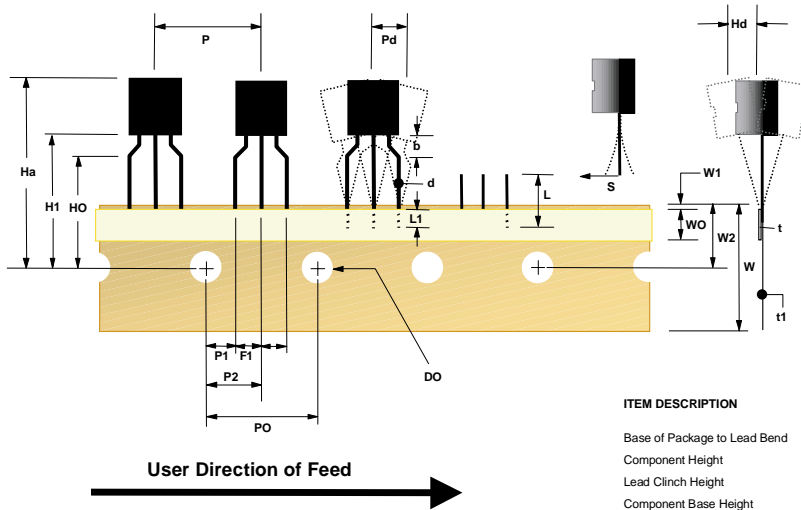

ITEM DESCRIPTION	SYMBOL	DIMENSION
Base of Package to Lead Bend	b	0.098 (max)
Component Height	Ha	0.928 (+/- 0.025)
Lead Clinch Height	HO	0.630 (+/- 0.020)
Component Base Height	H1	0.748 (+/- 0.020)
Component Alignment ( side/side )	Pd	0.040 (max)
Component Alignment ( front/back )	Hd	0.031 (max)
Component Pitch	P	0.500 (+/- 0.020)
Feed Hole Pitch	PO	0.500 (+/- 0.008)
Hole Center to First Lead	P1	0.150 (+0.009, -0.010)
Hole Center to Component Center	P2	0.247 (+/- 0.007)
Lead Spread	F1/F2	0.104 (+/- 0.010)
Lead Thickness	d	0.018 (+0.002, -0.003)
Cut Lead Length	L	0.429 (max)
Taped Lead Length	L1	0.209 (+0.051, -0.052)
Taped Lead Thickness	t	0.032 (+/- 0.006)
Carrier Tape Thickness	t1	0.021 (+/- 0.006)
Carrier Tape Width	W	0.708 (+0.020, -0.019)
Hold - down Tape Width	WO	0.236 (+/- 0.012)
Hold - down Tape position	W1	0.035 (max)
Feed Hole Position	W2	0.360 (+/- 0.025)
Sprocket Hole Diameter	DO	0.157 (+0.008, -0.007)
Lead Spring Out	S	0.004 (max)

Note : All dimensions are in inches.

**TO-92 Reel  
Configuration: Figure 5.0**

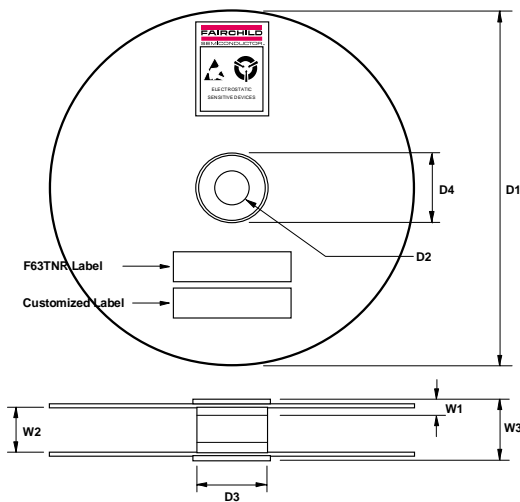

ITEM DESCRIPTION	SYMBOL	MINIMUM	MAXIMUM
Reel Diameter	D1	13.975	14.025
Arbor Hole Diameter (Standard)	D2	1.160	1.200
(Small Hole)	D2	0.650	0.700
Core Diameter	D3	3.100	3.300
Hub Recess Inner Diameter	D4	2.700	3.100
Hub Recess Depth	W1	0.370	0.570
Flange to Flange Inner Width	W2	1.630	1.690
Hub to Hub Center Width	W3		2.090

Note: All dimensions are in inches

# TO-92 Package Dimensions



## TO-92 (FS PKG Code 92, 94, 96)

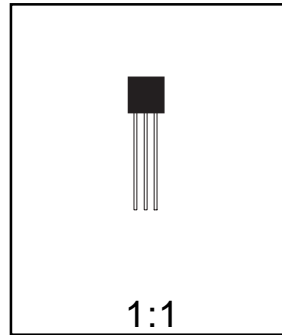

Scale 1:1 on letter size paper

Dimensions shown below are in:  
inches [millimeters]

Part Weight per unit (gram): 0.1977

TO-92 (92,94,96)

PIN	92		94		96	
	B	F	B	F	B	F
1	E	D	E	D	B	S
2	B	S	C	G	E	D
3	C	G	B	S	C	G

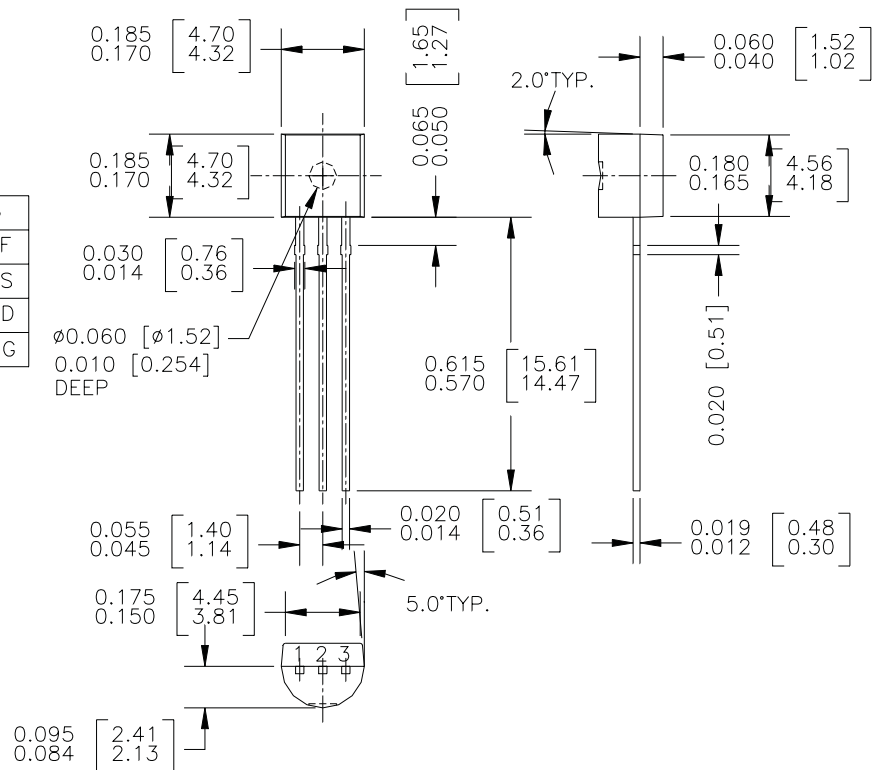



# SOT-23 Tape and Reel Data



## SOT-23 Packaging Configuration: Figure 10

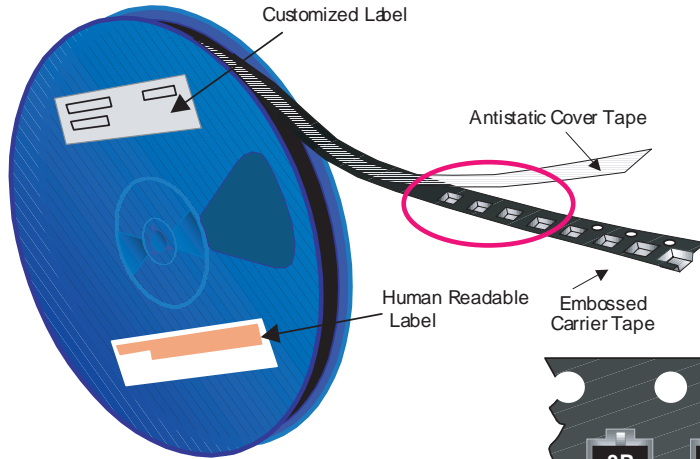

### Packaging Description:

SOT-23 parts are shipped in tape. The carrier tape is made from a dissipative (carbon filled) polycarbonate resin. The cover tape is a multilayer film (Heat Activated Adhesive in nature) primarily composed of polyester film, adhesive layer, sealant, and anti-static sprayed agent. These reeled parts in standard option are shipped with 3,000 units per 7" or 177mm diameter reel. The reels are dark blue in color and is made of polystyrene plastic (anti-static coated). Other option comes in 10,000 units per 13" or 330mm diameter reel. This and some other options are described in the Packaging Information table.

These full reels are individually labeled and placed inside a standard intermediate made of recyclable corrugated brown paper with a Fairchild logo printing. One pizza box contains eight reels maximum. And these intermediate boxes are placed inside a labeled shipping box which comes in different sizes depending on the number of parts shipped.

SOT-23 Packaging Information		
Packaging Option	Standard (no flow code)	D87Z
Packaging type	TNR	TNR
Qty per Reel/Tube/Bag	3,000	10,000
Reel Size	7" Dia	13"
Box Dimension (mm)	187x107x183	343x343x64
Max qty per Box	24,000	30,000
Weight per unit (gm)	0.0082	0.0082
Weight per Reel (kg)	0.1175	0.4006
Note/Comments		

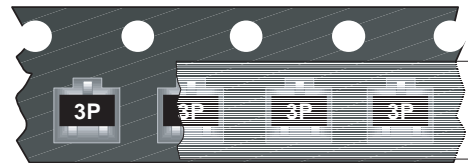

### SOT-23 Unit Orientation

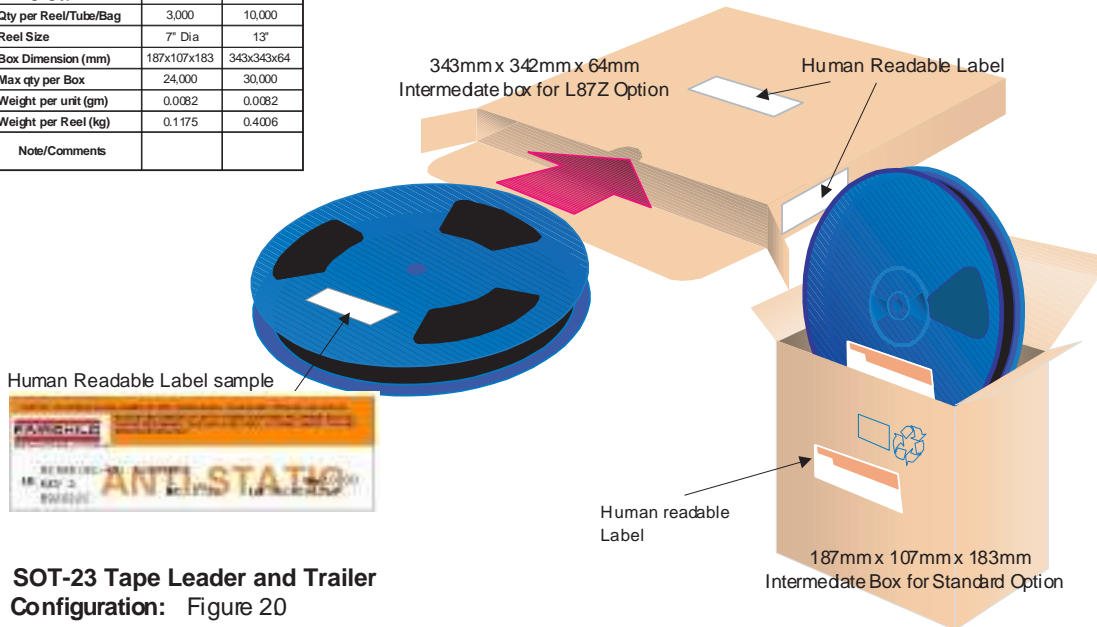

Human Readable Label sample



## SOT-23 Tape Leader and Trailer Configuration: Figure 20

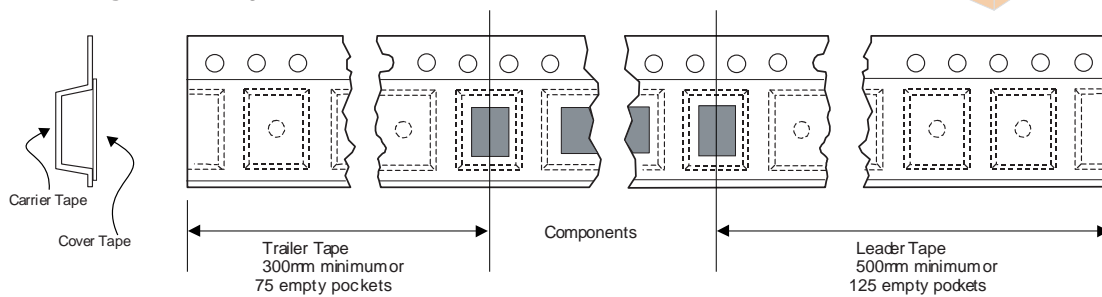

# SOT-23 Tape and Reel Data, continued

## SOT-23 Embossed Carrier Tape Configuration: Figure 3.0

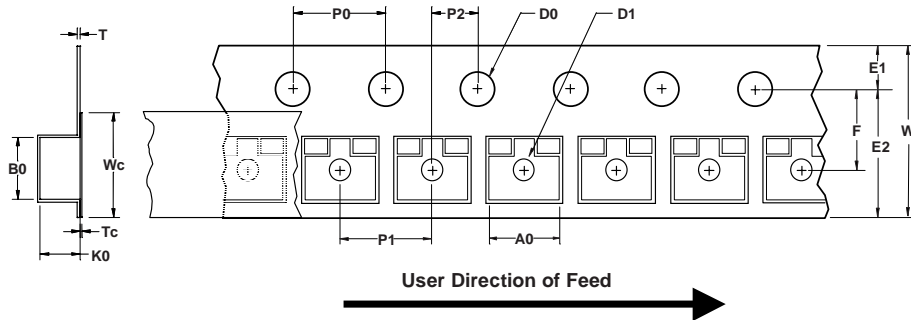

Dimensions are in millimeter

Pkg type	A0	B0	W	D0	D1	E1	E2	F	P1	P0	K0	T	Wc	Tc
SOT-23 (8mm)	3.15 +/-0.10	2.77 +/-0.10	8.0 +/-0.3	1.55 +/-0.05	1.125 +/-0.125	1.75 +/-0.10	6.25 min	3.50 +/-0.05	4.0 +/-0.1	4.0 +/-0.1	1.30 +/-0.10	0.228 +/-0.013	5.2 +/-0.3	0.06 +/-0.02

Notes: A0, B0, and K0 dimensions are determined with respect to the EIA/Jedec RS-481 rotational and lateral movement requirements (see sketches A, B, and C).

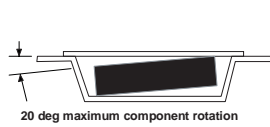

Sketch A (Side or Front Sectional View)  
Component Rotation

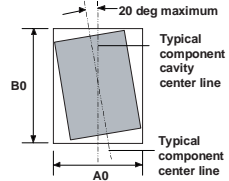

Sketch B (Top View)  
Component Rotation

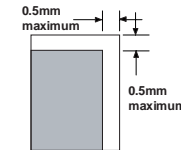

Sketch C (Top View)  
Component lateral movement

## SOT-23 Reel Configuration: Figure 4.0

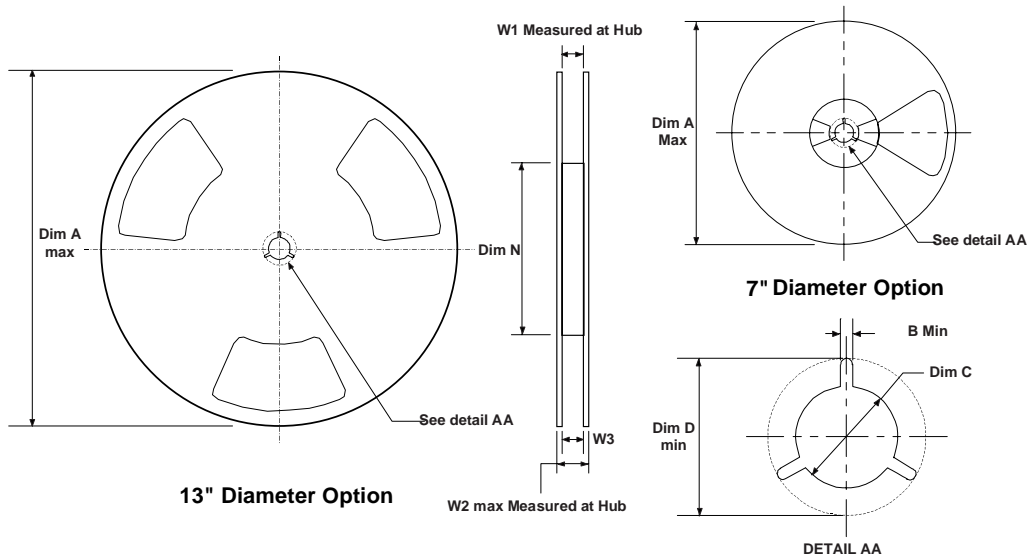

Dimensions are in inches and millimeters

Tape Size	Reel Option	Dim A	Dim B	Dim C	Dim D	Dim N	Dim W1	Dim W2	Dim W3 (LSL-USL)
8mm	7" Dia	7.00 177.8	0.059 1.5	512 +0.020/-0.008 13 +0.5/-0.2	0.795 20.2	2.165 55	0.331 +0.059/-0.000 8.4 +1.5/0	0.567 14.4	0.311 -0.429 7.9 - 10.9
8mm	13" Dia	13.00 330	0.059 1.5	512 +0.020/-0.008 13 +0.5/-0.2	0.795 20.2	4.00 100	0.331 +0.059/-0.000 8.4 +1.5/0	0.567 14.4	0.311 -0.429 7.9 - 10.9

# SOT-23 Package Dimensions



## SOT-23 (FS PKG Code 49)

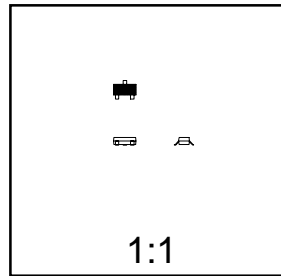

Scale 1:1 on letter size paper

Dimensions shown below are in:  
inches [millimeters]

Part Weight per unit (gram): 0.0082

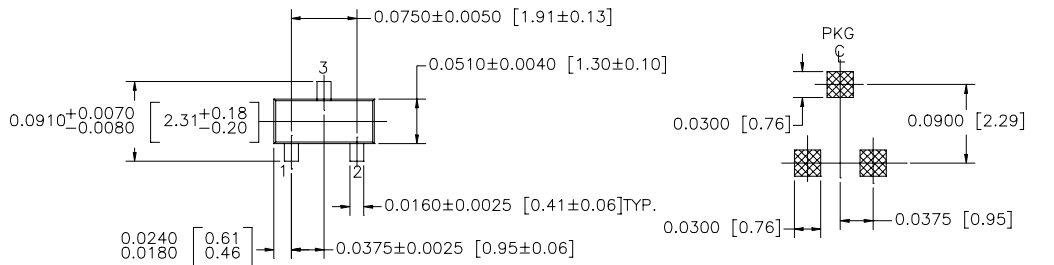

LAND PATTERN RECOMMENDATION

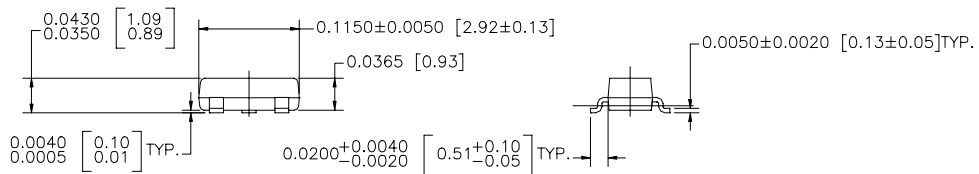

CONTROLLING DIMENSION IS INCH  
VALUES IN [ ] ARE MILLIMETERS

SOT 23, 3 LEADS LOW PROFILE

NOTE : UNLESS OTHERWISE SPECIFIED

- STANDARD LEAD FINISH 150 MICRONS / 3.81 MICROMETERS  
MINIMUM TIN / LEAD (SOLDER) ON ALLOY 42
- REFERENCE JEDEC REGISTRATION TO-236, VARIATION AB, ISSUE G, DATED JUL 1993

## TRADEMARKS

The following are registered and unregistered trademarks Fairchild Semiconductor owns or is authorized to use and is not intended to be an exhaustive list of all such trademarks.

ACE <sup>x</sup> ™	FAST <sup>r</sup> ™	PowerTrench®	SyncFET™
Bottomless™	GlobalOptoisolator™	QFET™	TinyLogic™
CoolFET™	GTO™	QST™	UHC™
CROSSVOLT™	HiSeC™	QT Optoelectronics™	VCX™
DOME™	ISOPLANAR™	Quiet Series™	
E <sup>2</sup> CMOS™	MICROWIRE™	SILENT SWITCHER®	
EnSigna™	OPTOLOGIC™	SMART START™	
FACT™	OPTOPLANAR™	SuperSOT™-3	
FACT Quiet Series™	PACMAN™	SuperSOT™-6	
FAST®	POP™	SuperSOT™-8	

## DISCLAIMER

FAIRCHILD SEMICONDUCTOR RESERVES THE RIGHT TO MAKE CHANGES WITHOUT FURTHER NOTICE TO ANY PRODUCTS HEREIN TO IMPROVE RELIABILITY, FUNCTION OR DESIGN. FAIRCHILD DOES NOT ASSUME ANY LIABILITY ARISING OUT OF THE APPLICATION OR USE OF ANY PRODUCT OR CIRCUIT DESCRIBED HEREIN; NEITHER DOES IT CONVEY ANY LICENSE UNDER ITS PATENT RIGHTS, NOR THE RIGHTS OF OTHERS.

## LIFE SUPPORT POLICY

FAIRCHILD'S PRODUCTS ARE NOT AUTHORIZED FOR USE AS CRITICAL COMPONENTS IN LIFE SUPPORT DEVICES OR SYSTEMS WITHOUT THE EXPRESS WRITTEN APPROVAL OF FAIRCHILD SEMICONDUCTOR CORPORATION. As used herein:

1. Life support devices or systems are devices or systems which, (a) are intended for surgical implant into the body, or (b) support or sustain life, or (c) whose failure to perform when properly used in accordance with instructions for use provided in the labeling, can be reasonably expected to result in significant injury to the user.
2. A critical component is any component of a life support device or system whose failure to perform can be reasonably expected to cause the failure of the life support device or system, or to affect its safety or effectiveness.

## PRODUCT STATUS DEFINITIONS

### Definition of Terms

Datasheet Identification	Product Status	Definition
Advance Information	Formative or In Design	This datasheet contains the design specifications for product development. Specifications may change in any manner without notice.
Preliminary	First Production	This datasheet contains preliminary data, and supplementary data will be published at a later date. Fairchild Semiconductor reserves the right to make changes at any time without notice in order to improve design.
No Identification Needed	Full Production	This datasheet contains final specifications. Fairchild Semiconductor reserves the right to make changes at any time without notice in order to improve design.
Obsolete	Not In Production	This datasheet contains specifications on a product that has been discontinued by Fairchild semiconductor. The datasheet is printed for reference information only.