

QSE256, QSE257, QSE258, QSE259 Plastic Silicon OPTOLOGIC® Photosensor

Features

- Bipolar silicon IC
- Package type: Sidelooker
- Medium wide reception angle, 50°
- Package material and color: black epoxy
- Daylight filter
- High sensitivity
- Direct TTL/LSTTL interface

Description

The QSE25x family are OPTOLOGIC® ICs which feature a Schmitt trigger at output which provides hysteresis for noise immunity and pulse shaping. The basic building block of this IC consists of a photodiode, a linear amplifier, voltage regulator, Schmitt trigger and four output options. The TTL/LSTTL compatible output can drive up to ten TTL loads over supply currents from 4.5 to 16.0 Volts. The devices are marked with a color stripe for easy identification.

Package Dimensions

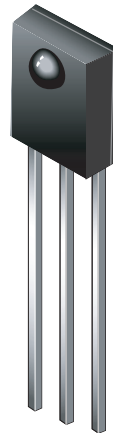
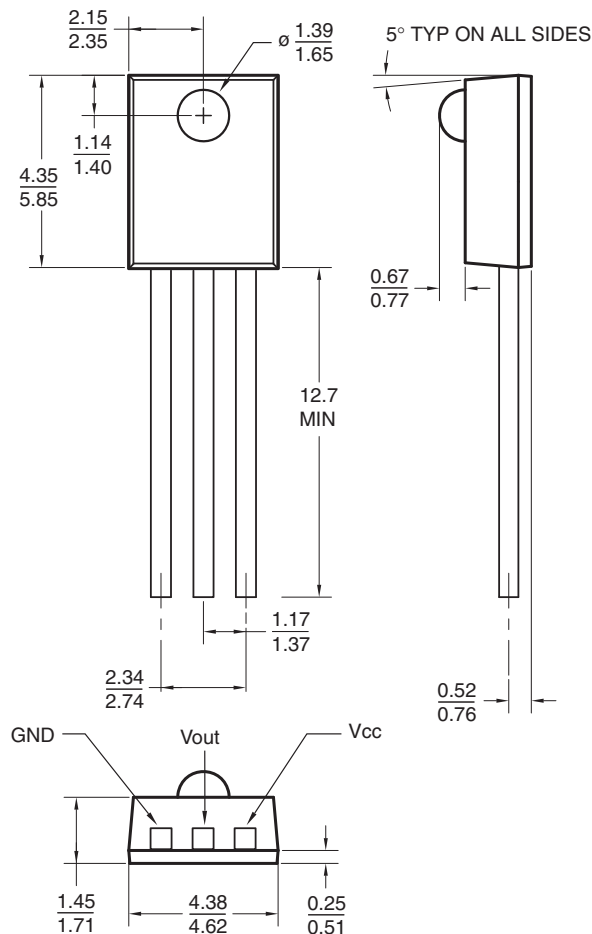

Part Number Definitions		Color Code
QSE256	Totem-Pole, buffer output	Red
QSE257	Totem-Pole, inverter output	Yellow
QSE258	Open-collector, buffer output	Green
QSE259	Open-collector, inverter output	Blue

Input/Output Table		
Part Number	Light	Output
QSE256	On	HIGH
	Off	LOW
QSE257	On	LOW
	Off	HIGH
QSE258	On	HIGH
	Off	LOW
QSE259	On	LOW
	Off	HIGH

Note:

1. Dimensions for all drawings are in millimeters.

Block Diagrams

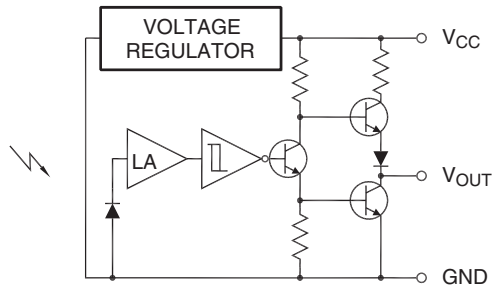

QSE256
Totem-Pole Output Buffer

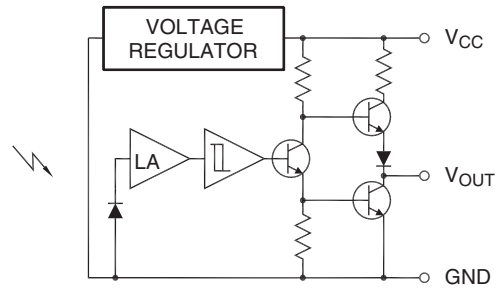

QSE257
Totem-Pole Output Inverter

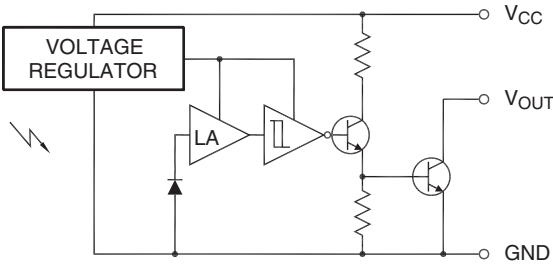

QSE258
Open-Collector Output Buffer

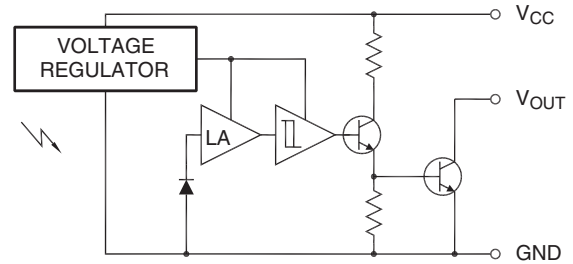

QSE259
Open-Collector Output Inverter

Absolute Maximum Ratings ($T_A = 25^\circ\text{C}$ unless otherwise specified)

Stresses exceeding the absolute maximum ratings may damage the device. The device may not function or be operable above the recommended operating conditions and stressing the parts to these levels is not recommended. In addition, extended exposure to stresses above the recommended operating conditions may affect device reliability. The absolute maximum ratings are stress ratings only.

Symbol	Parameter	Rating	Unit
T_{OPR}	Operating Temperature	-40 to +85	$^\circ\text{C}$
T_{STG}	Storage Temperature	-40 to +100	$^\circ\text{C}$
T_{SOL-I}	Soldering Temperature (Iron) ^(2,3,4)	240 for 5 sec	$^\circ\text{C}$
T_{SOL-F}	Soldering Temperature (Flow) ^(2,3)	260 for 10 sec	$^\circ\text{C}$
I_O	Output Current	50	mA
V_{CC}	Supply Voltage	4.0 to 16	V
V_O	Output Voltage	35	V
P_D	Power Dissipation ⁽¹⁾	100	mW

Notes:

1. Derate power dissipation linearly 2.50mW/ $^\circ\text{C}$ above 25 $^\circ\text{C}$.
2. RMA flux is recommended.
3. Methanol or isopropyl alcohols are recommended as cleaning agents.
4. Soldering iron tip 1/16" (1.6mm) minimum from housing.

Electrical Characteristics ($T_A = -40^{\circ}\text{C}$ to $+85^{\circ}\text{C}$, $V_{CC} = 4.5\text{V}$ to 5.5V)

Symbol	Parameter	Test Conditions	Min.	Typ.	Max.	Units
Ee(+)	Positive Going Threshold Irradiance ⁽⁵⁾	$T_A = 25^{\circ}\text{C}$	0.025		0.250	mW/cm^2
Ee(+)/Ee(-)	Hysteresis Ratio		1.10		2.00	
I_{CC}	Supply Current ⁽⁵⁾	Ee = 0 or $0.3\text{mW}/\text{cm}^2$			5.0	mA
	Peak to Peak Ripple which will Cause False Triggering	f = DC to 50MHz			2.00	V
QSE256 (Buffer Totem Pole)						
V_{OH}	High Level Output Voltage ⁽⁵⁾	Ee = $0.3\text{mW}/\text{cm}^2$, $I_{OH} = -10\text{mA}$	2.4			V
V_{OL}	Low Level Output Voltage	Ee = 0, $I_{OL} = 16\text{mA}$			0.40	V
QSE257 (Inverter Totem Pole)						
V_{OH}	High Level Output Voltage	Ee = 0, $I_{OH} = -10\text{mA}$	2.4			V
V_{OL}	Low Level Output Voltage ⁽⁵⁾	Ee = $0.3\text{mW}/\text{cm}^2$, $I_{OL} = 16\text{mA}$			0.40	V
QSE258 (Buffer Open Collector)						
I_{OH}	High Level Output Current ⁽⁵⁾	Ee = $0.3\text{mW}/\text{cm}^2$, $V_{OH} = 30\text{V}$			100	μA
V_{OL}	Low Level Output Voltage	Ee = 0, $I_{OL} = 16\text{mA}$			0.40	V
QSE259 (Inverter Open Collector)						
I_{OH}	High Level Output Current	Ee = 0, $V_{OH} = 30\text{V}$			100	μA
V_{OL}	Low Level Output Voltage ⁽⁵⁾	Ee = $0.3\text{mW}/\text{cm}^2$, $I_{OL} = 16\text{mA}$			0.40	V
QSE256, QSE257						
t_R, t_F	Output Rise, Fall Times	Ee = 0 or $0.3\text{mW}/\text{cm}^2$, f = 10kHz, DC = 50%, $R_L = 360\Omega$ ⁽⁵⁾			70	nS
t_{PHL}, t_{PLH}	Propagation Delay			6.0		μS
QSE258, QSE259						
t_R, t_F	Output Rise, Fall Times	Ee = 0 or $0.3\text{mW}/\text{cm}^2$, f = 10kHz, DC = 50%, $R_L = 360\Omega$ ⁽⁵⁾			100	nS
t_{PHL}, t_{PLH}	Propagation Delay			6.0		μS

Note:

5. $\lambda = 880\text{nm}$ (AlGaAs).

Typical Performance Curves (Sensor Coupled to QEE113 Emitter)

Fig. 1 Output Voltage vs. Input Current (Inverters)

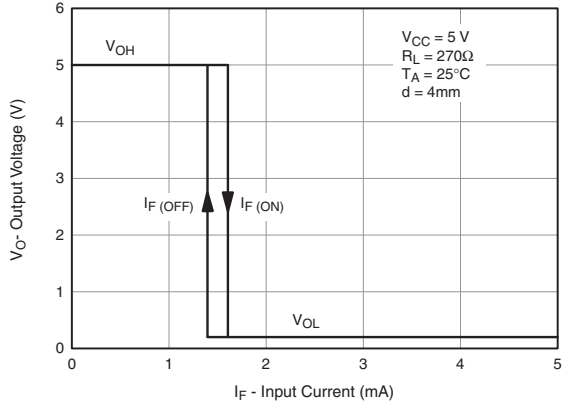

Fig. 2 Output Voltage vs. Input Current (Buffers)

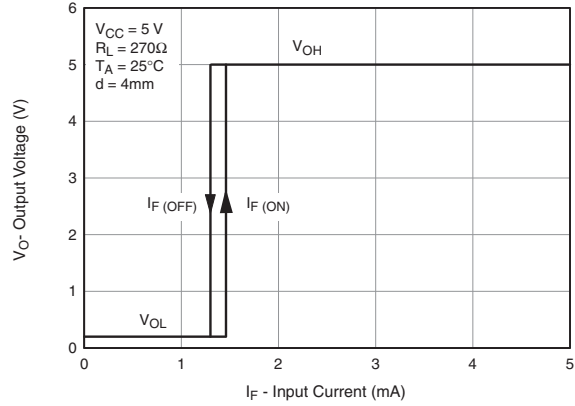

Fig. 3 Threshold Current vs. Distance

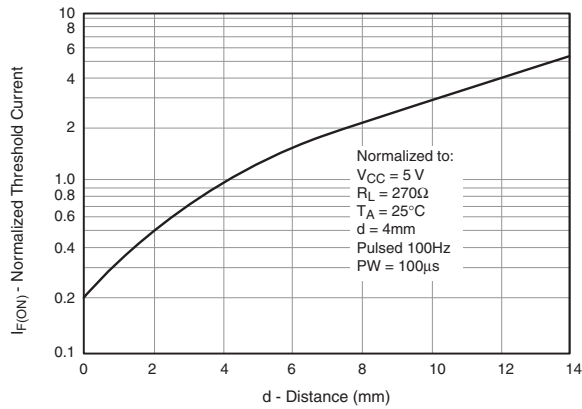
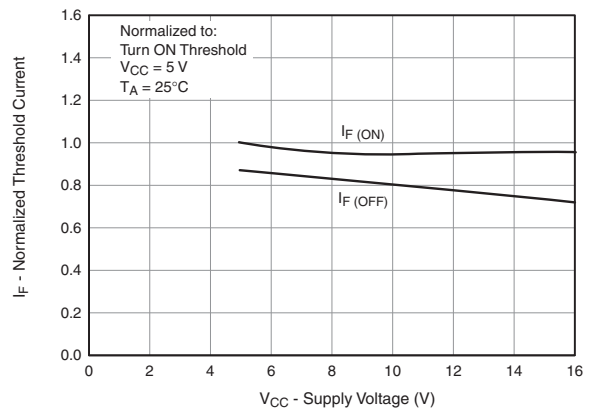

Fig. 4 Normalized Threshold Current vs. Supply Voltage



Typical Performance Curves (Sensor Coupled to QEE113 Emitter) (Continued)

Fig. 5 Normalized Threshold Current vs. Ambient Temperature

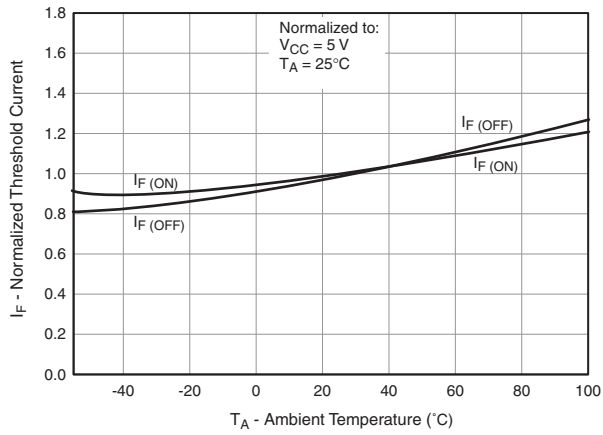

Fig. 6 Low Output Voltage vs. Output Current

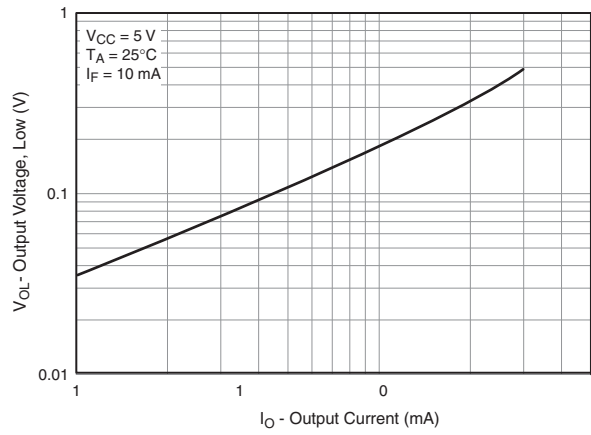

Fig. 7 Response Time vs. Forward Current

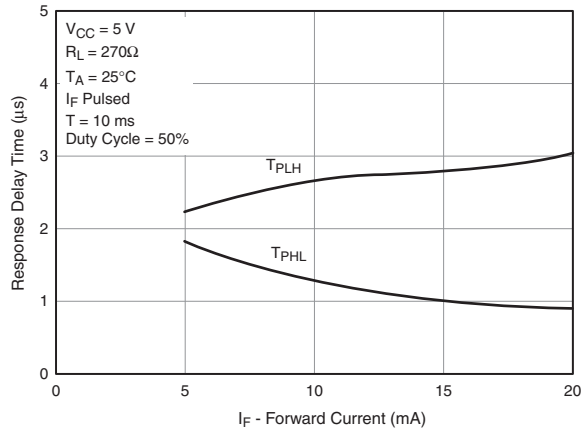

Fig. 8 Switching Speed Test Circuit

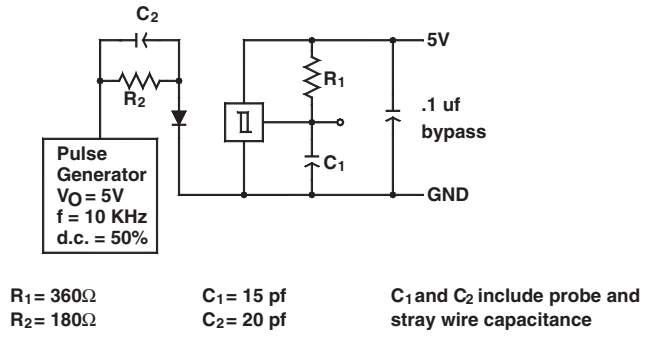

Fig. 9 Switching Times Definition for Buffers

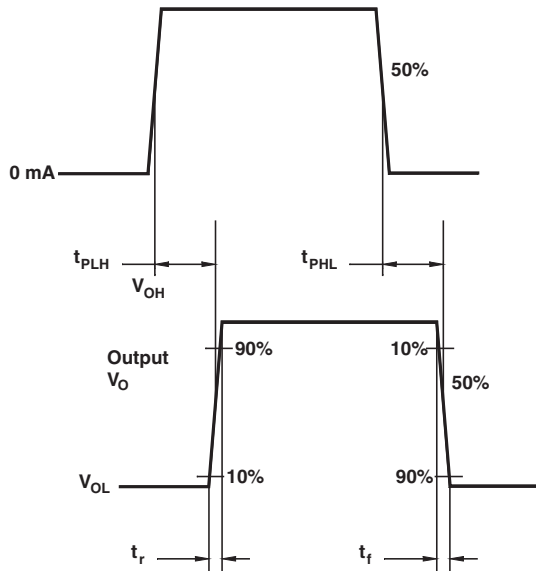
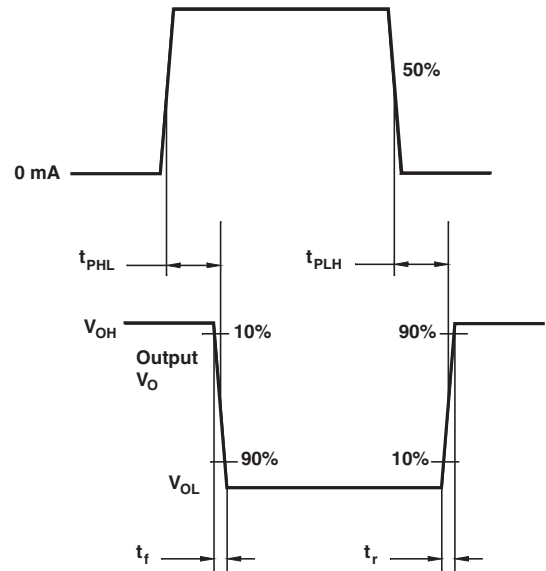

Fig. 10 Switching Times Definition for Inverters





TRADEMARKS

The following includes registered and unregistered trademarks and service marks, owned by Fairchild Semiconductor and/or its global subsidiaries, and is not intended to be an exhaustive list of all such trademarks.

2Cool™	F-PFS™	PowerTrench®	The Power Franchise®
AccuPower™	FRFET®	PowerXS™	the power franchise
AX-CAP™*	Global Power Resource™	Programmable Active Droop™	TinyBoost™
BitSiC™	GreenBridge™	QFET®	TinyBuck™
Build it Now™	Green FPS™	QS™	TinyCalc™
CorePLUS™	Green FPS™ e-Series™	Quiet Series™	TinyLogic®
CorePOWER™	Gmax™	RapidConfigure™	TINYOPTO™
CROSSVOL™	GTO™	 ™	TinyPower™
CTL™	IntelliMAX™	Saving our world, 1mW/W/kW at a time™	TinyPWM™
Current Transfer Logic™	ISOPLANAR™	SignalWise™	TinyWire™
DEUXPEED®	Making Small Speakers Sound Louder and Better™	SmartMax™	TranSiC™
Dual Cool™	MegaBuck™	SMART START™	TriFault Detect™
EcoSPARK®	MICROCOUPLER™	Solutions for Your Success™	TRUECURRENT®*
EfficientMax™	MicroFET™	SPM®	µSerDes™
ESBC™	MicroPak™	STEALTH™	 ™
 Fairchild®	MicroPak2™	SuperFET®	UHC®
Fairchild Semiconductor®	MillerDrive™	SuperSOT™-3	Ultra FRFET™
FACT Quiet Series™	MotionMax™	SuperSOT™-6	UniFET™
FACT®	mWSaver™	SuperSOT™-8	VCX™
FAST®	OptoHiT™	SupreMOS®	VisualMax™
FastvCore™	OPTOLOGIC®	SyncFET™	VoltagePlus™
FETBench™	OPTOPLANAR®	Sync-Lock™	XS™
FlashWriter®*		 SYSTEM GENERAL®*	
FPS™			

* Trademarks of System General Corporation, used under license by Fairchild Semiconductor.

DISCLAIMER

FAIRCHILD SEMICONDUCTOR RESERVES THE RIGHT TO MAKE CHANGES WITHOUT FURTHER NOTICE TO ANY PRODUCTS HEREIN TO IMPROVE RELIABILITY, FUNCTION, OR DESIGN. FAIRCHILD DOES NOT ASSUME ANY LIABILITY ARISING OUT OF THE APPLICATION OR USE OF ANY PRODUCT OR CIRCUIT DESCRIBED HEREIN; NEITHER DOES IT CONVEY ANY LICENSE UNDER ITS PATENT RIGHTS, NOR THE RIGHTS OF OTHERS. THESE SPECIFICATIONS DO NOT EXPAND THE TERMS OF FAIRCHILD'S WORLDWIDE TERMS AND CONDITIONS, SPECIFICALLY THE WARRANTY THEREIN, WHICH COVERS THESE PRODUCTS.

LIFE SUPPORT POLICY

FAIRCHILD'S PRODUCTS ARE NOT AUTHORIZED FOR USE AS CRITICAL COMPONENTS IN LIFE SUPPORT DEVICES OR SYSTEMS WITHOUT THE EXPRESS WRITTEN APPROVAL OF FAIRCHILD SEMICONDUCTOR CORPORATION.

As used herein:

1. Life support devices or systems are devices or systems which, (a) are intended for surgical implant into the body or (b) support or sustain life, and (c) whose failure to perform when properly used in accordance with instructions for use provided in the labeling, can be reasonably expected to result in a significant injury of the user.
2. A critical component in any component of a life support, device, or system whose failure to perform can be reasonably expected to cause the failure of the life support device or system, or to affect its safety or effectiveness.

ANTI-COUNTERFEITING POLICY

Fairchild Semiconductor Corporation's Anti-Counterfeiting Policy. Fairchild's Anti-Counterfeiting Policy is also stated on our external website, www.fairchildsemi.com, under Sales Support.

Counterfeiting of semiconductor parts is a growing problem in the industry. All manufacturers of semiconductor products are experiencing counterfeiting of their parts. Customers who inadvertently purchase counterfeit parts experience many problems such as loss of brand reputation, substandard performance, failed applications, and increased cost of production and manufacturing delays. Fairchild is taking strong measures to protect ourselves and our customers from the proliferation of counterfeit parts. Fairchild strongly encourages customers to purchase Fairchild parts either directly from Fairchild or from Authorized Fairchild Distributors who are listed by country on our web page cited above. Products customers buy either from Fairchild directly or from Authorized Fairchild Distributors are genuine parts, have full traceability, meet Fairchild's quality standards for handling and storage and provide access to Fairchild's full range of up-to-date technical and product information. Fairchild and our Authorized Distributors will stand behind all warranties and will appropriately address any warranty issues that may arise. Fairchild will not provide any warranty coverage or other assistance for parts bought from Unauthorized Sources. Fairchild is committed to combat this global problem and encourage our customers to do their part in stopping this practice by buying direct or from authorized distributors.

PRODUCT STATUS DEFINITIONS

Definition of Terms

Datasheet Identification	Product Status	Definition
Advance Information	Formative / In Design	Datasheet contains the design specifications for product development. Specifications may change in any manner without notice.
Preliminary	First Production	Datasheet contains preliminary data; supplementary data will be published at a later date. Fairchild Semiconductor reserves the right to make changes at any time without notice to improve design.
No Identification Needed	Full Production	Datasheet contains final specifications. Fairchild Semiconductor reserves the right to make changes at any time without notice to improve the design.
Obsolete	Not In Production	Datasheet contains specifications on a product that is discontinued by Fairchild Semiconductor. The datasheet is for reference information only.

Rev. I62