

DATA SHEET

SKY67001-396LF: 0.6-1.2 GHz High Linearity, Active Bias Low-Noise Amplifier

Applications

- GSM, CDMA, WCDMA, TD-SCDMA cellular infrastructure
- Ultra low-noise systems
- Balanced, single-ended low-noise amplifier designs

Features

- Extended operating temperature range: -40 °C to +100 °C
- Low Noise Figure: 0.6 dB @ 0.9 GHz
- Excellent IIP3 performance: +23 dBm @ 0.9 GHz
- Gain: 17.5 dB @ 0.9 GHz
- Adjustable supply current
- Integrated enable circuitry
- Temperature and process-stable active bias
- Miniature DFN (8-pin, 2 x 2 mm) package (MSL1 @ 260 °C per JEDEC J-STD-020)



Skyworks Green™ products are compliant with all applicable legislation and are halogen-free. For additional information, refer to *Skyworks Definition of Green™*, document number SQ04-0074.

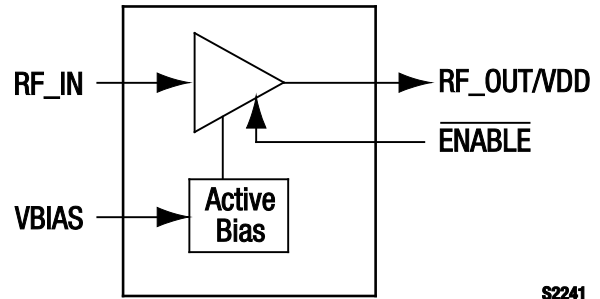

Figure 1. SKY67001-396LF Block Diagram

Description

The SKY67001-396LF is GaAs, pHEMT Low-Noise Amplifier (LNA) with an active bias and high linearity performance. The advanced GaAs pHEMT enhancement mode process provides good return loss, low noise, and high linearity performance.

The internal active bias circuitry provides stable performance over temperature and process variation. The device offers the ability to externally adjust supply current and gain. Supply voltage is applied to the RFOUT/VDD pin through an RF choke inductor. Pin 3 (VBIAS) should be connected to RFOUT/VDD through an external resistor to control the supply current. The RFIN and RFOUT/VDD pins should be DC blocked to ensure proper operation.

The SKY67001-396LF operates in the frequency range of 0.6 to 1.2 GHz. For higher frequency operation, the pin-compatible SKY67002-396LF or SKY67003-396LF should be used.

The LNA is manufactured in a compact, 2 x 2 mm, 8-pin Dual Flat No-Lead (DFN) package. A functional block diagram is shown in Figure 1. The pin configuration and package are shown in Figure 2. Signal pin assignments and functional pin descriptions are provided in Table 1.

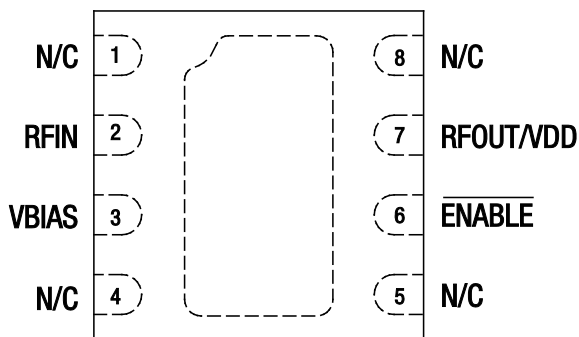

S2240

Figure 2. SKY67001-396LF Pinout – 8-Pin DFN (Top View)

Table 1. SKY67001-396LF Signal Descriptions

| Pin # | Name | Description | Pin # | Name | Description |
|-------|-------|---|-------|-----------|---|
| 1 | N/C | No connection. May be connected to ground with no change in performance. | 5 | N/C | No connection. May be connected to ground with no change in performance. |
| 2 | RFIN | RF input. DC blocking capacitor required. | 6 | ENABLE | Enable pin. Active “low” (0 V) = amplifier on state. |
| 3 | VBIAS | Bias for 1 st stage amplifier. External resistor sets current consumption. | 7 | RFOUT/VDD | RF output. Apply VDD through RF choke inductor. DC blocking capacitor required. |
| 4 | N/C | No connection. May be connected to ground with no change in performance. | 8 | N/C | No connection. May be connected to ground with no change in performance. |

Table 2. SKY67001-396LF Absolute Maximum Ratings

| Parameter | Symbol | Minimum | Typical | Maximum | Units |
|-----------------------|------------------|---------|---------|---------|-------|
| Supply voltage | V _{DD} | | | 5.5 | V |
| RF input power | P _{IN} | | | +20 | dBm |
| Channel temperature | T _{CH} | | | +150 | °C |
| Thermal resistance | Θ _{JC} | | 56.4 | | °C/W |
| Storage temperature | T _{STG} | -65 | +25 | +150 | °C |
| Operating temperature | T _A | -55 | +25 | +100 | °C |

Notes: Exposure to maximum rating conditions for extended periods may reduce device reliability. There is no damage to device with only one parameter set at the limit and all other parameters set at or below their nominal value. Exceeding any of the limits listed here may result in permanent damage to the device.

Thermal resistance = 56.4 °C/W @ 5 V bias.

CAUTION: Although this device is designed to be as robust as possible, Electrostatic Discharge (ESD) can damage this device. This device must be protected at all times from ESD. Static charges may easily produce potentials of several kilovolts on the human body or equipment, which can discharge without detection. Industry-standard ESD precautions should be used at all times. The SKY67001-396LF ESD threshold level is 500 VDC using Human Body Model (HBM) testing (Class 1B), 30 VDC using Man-Machine (MM) model testing (Class A), and 1000 VDC using Charged Device Model (CDM) testing (Class IV).

Electrical and Mechanical Specifications

The absolute maximum ratings of the SKY67001-396LF are provided in Table 2. Electrical specifications are provided in Table 3.

Typical performance characteristics of the SKY67001-396LF are illustrated in Figures 3 through 28.

Table 4 provides noise source pull information versus frequency.

Table 3. SKY67001-396LF Electrical Specifications (Note 1, 2)**(V_{DD} = 5 V, I_{DD} = 100 mA, T_A = +25 °C, P_{IN} = -20 dBm, Characteristic Impedance [Z₀] = 50 Ω, Unless Otherwise Noted)**

| Parameter | Symbol | Test Condition | Min | Typical | Max | Units |
|--|-----------------|--|-------|---------|------|-------|
| RF Specifications | | | | | | |
| Noise Figure (Note 3) | NF | @ 0.9 GHz | | 0.60 | 0.75 | dB |
| Small signal gain | IS21I | @ 0.9 GHz | 16.5 | 17.5 | 18.5 | dB |
| Input return loss | IS11I | @ 0.9 GHz | 11.0 | 12.5 | | dB |
| Output return loss | IS22I | @ 0.9 GHz | 8.0 | 9.5 | | dB |
| Reverse isolation | IS12I | @ 0.9 GHz | 27 | 29 | | dB |
| 3 rd Order Input Intercept Point | IIP3 | @ 0.9 GHz, Δf = 1 MHz, P _{IN} = -20 dBm/tone | +21.5 | +23.0 | | dBm |
| 3 rd Order Output Intercept Point | OIP3 | @ 0.9 GHz, Δf = 1 MHz, P _{IN} = -10 dBm/tone | +39.0 | +40.5 | | dBm |
| 1 dB Input Compression Point | IP1dB | @ 0.9 GHz | +3.5 | +4.5 | | dBm |
| 1 dB Output Compression Point | OP1dB | @ 0.9 GHz | +20 | +21 | | dBm |
| Stability (Note 4) | μ, μ1 | Up to 18 GHz, -40 °C to +85 °C | | > 1 | | - |
| DC Specifications | | | | | | |
| Supply voltage | V _{DD} | | 3.3 | 5.0 | | V |
| Quiescent supply current | I _{DD} | Set with external resistor | 30 | 100 | | mA |
| Amplifier enable off current (logic "high") | I _{EN} | | | 700 | 1000 | μA |
| Enable rise time | T _R | @ 0.9 GHz | | | 100 | μs |
| Enable fall time | T _F | @ 0.9 GHz | | | 100 | μs |

Note 1: Performance is guaranteed only under the conditions listed in this Table.**Note 2:** Circuit topology optimized for balanced configuration with best IIP3 and NF performance.**Note 3:** Loss from the input SMA connector and Evaluation Board up to component M1 has not been de-embedded from the NF measurement.**Note 4:** Applies to typical application circuit and components shown in Figure 31.

Typical Performance Characteristics

(V_{DD} = 5 V, I_{DD} = 100 mA, T_A = +25 °C, P_{IN} = -20 dBm, Characteristic Impedance [Z₀] = 50 Ω, Unless Otherwise Noted)

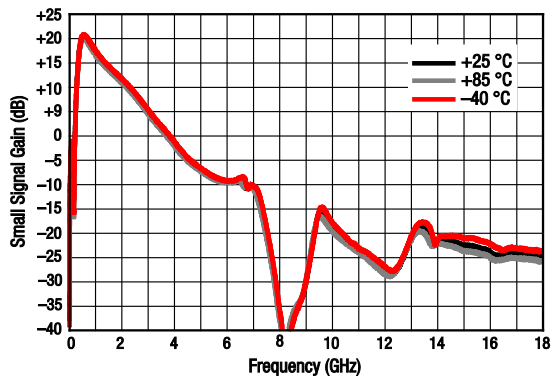

Figure 3. Broadband Gain Response vs Frequency Over Temperature

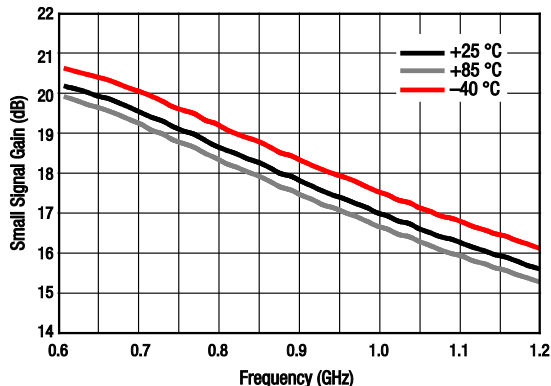

Figure 4. Narrowband Gain Response vs Frequency Over Temperature

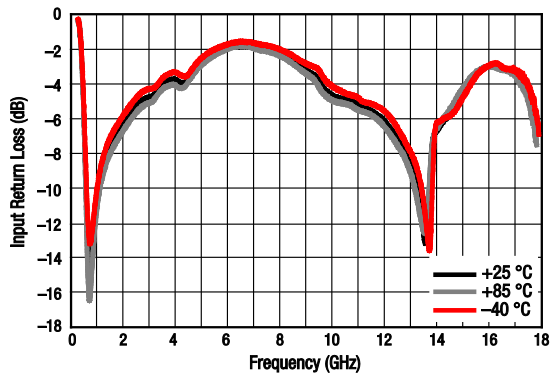

Figure 5. Broadband Input Return Loss vs Frequency Over Temperature

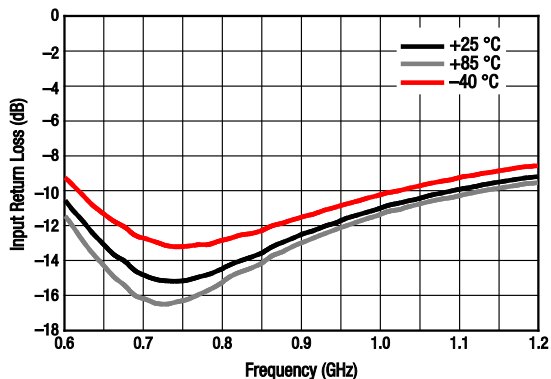

Figure 6. Narrowband Input Return Loss vs Frequency Over Temperature

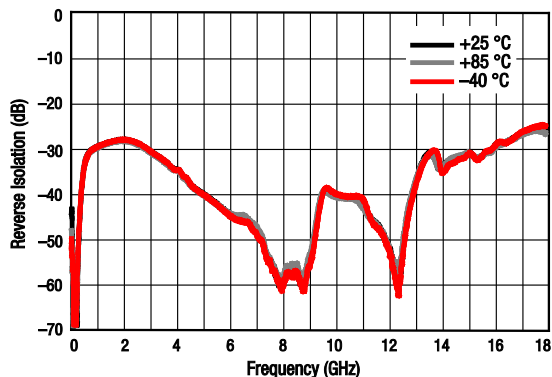

Figure 7. Broadband Reverse Isolation vs Frequency Over Temperature

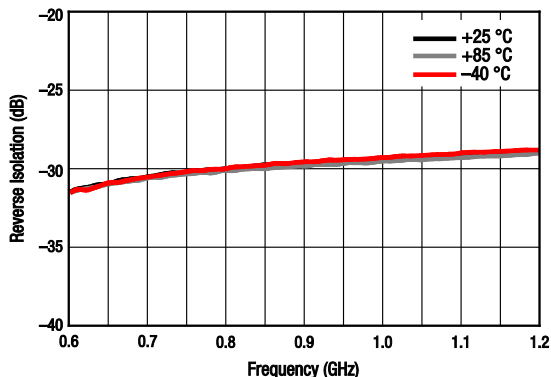

Figure 8. Narrowband Reverse Isolation vs Frequency Over Temperature

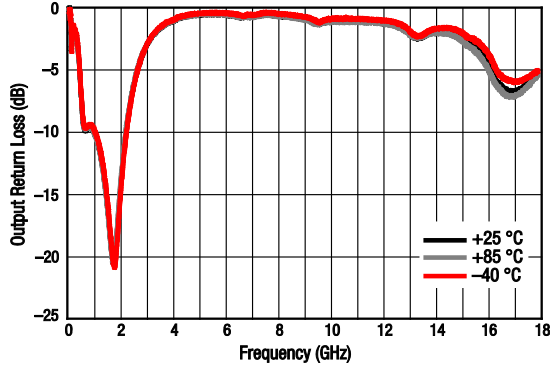

Figure 9. Broadband Output Return Loss vs Frequency Over Temperature

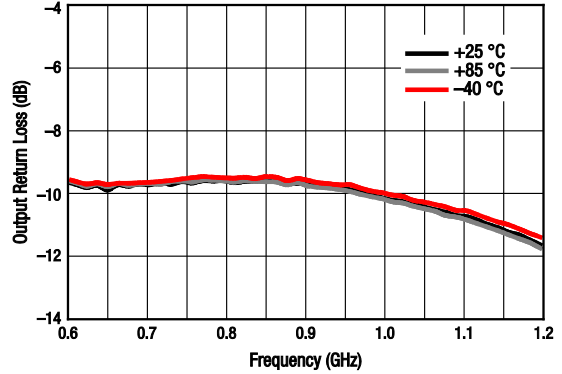

Figure 10. Narrowband Output Return Loss vs Frequency Over Temperature

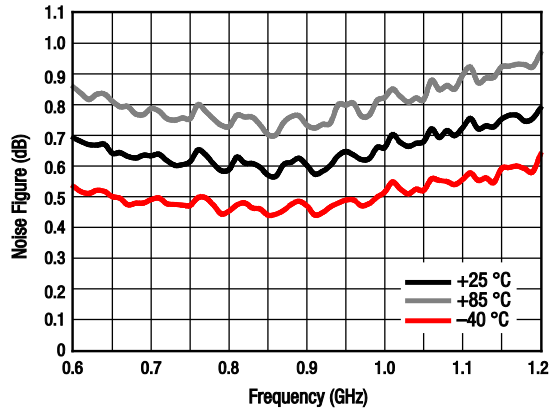

Figure 11. Noise Figure vs Frequency Over Temperature

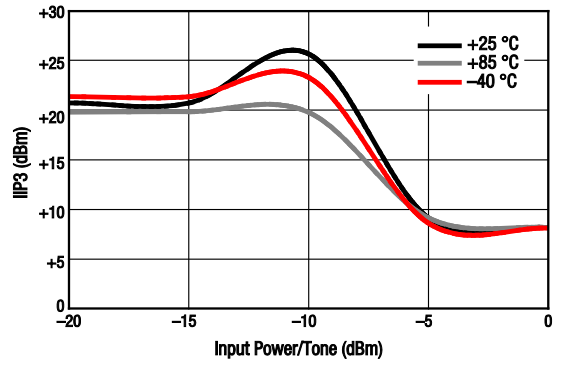

Figure 12. IIP3 vs Input Power Over Temperature @ 600 MHz ($P_{IN} = -20$ dBm, Tone Spacing = 1 MHz)

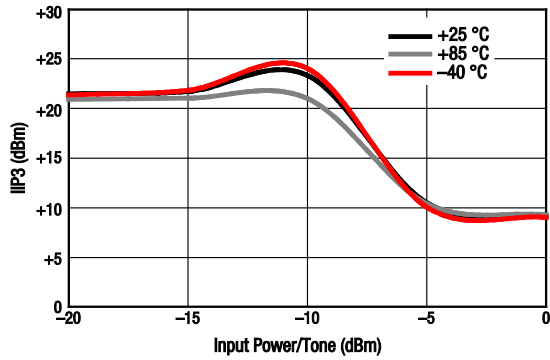

Figure 13. IIP3 vs Input Power Over Temperature @ 700 MHz ($P_{IN} = -20$ dBm, Tone Spacing = 1 MHz)

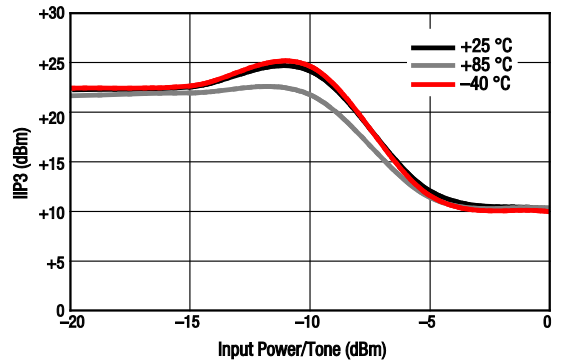

Figure 14. IIP3 vs Input Power Over Temperature @ 800 MHz ($P_{IN} = -20$ dBm, Tone Spacing = 1 MHz)

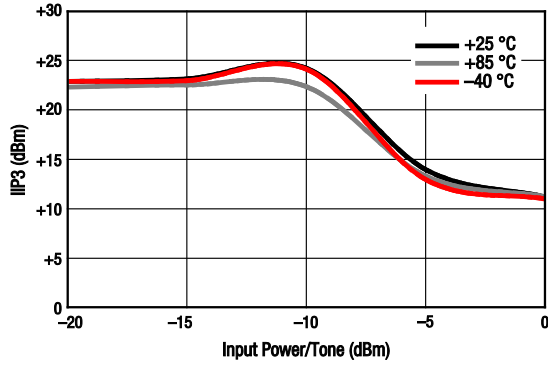

Figure 15. IIP3 vs Input Power Over Temperature @ 900 MHz ($P_{IN} = -20$ dBm, Tone Spacing = 1 MHz)

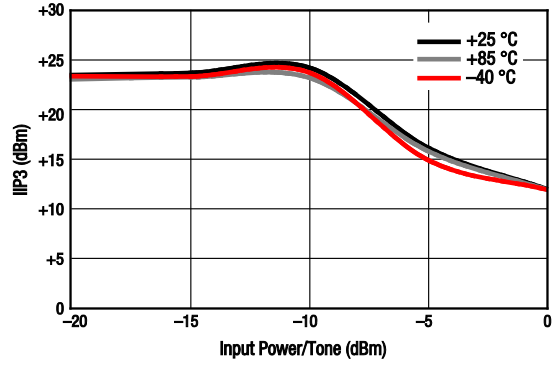

Figure 16. IIP3 vs Input Power Over Temperature @ 1000 MHz ($P_{IN} = -20$ dBm, Tone Spacing = 1 MHz)

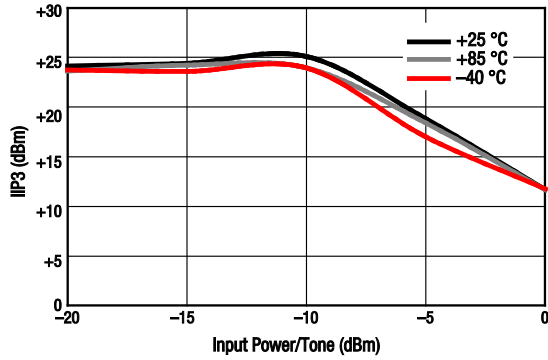

Figure 17. IIP3 vs Input Power Over Temperature @ 1200 MHz ($P_{IN} = -20$ dBm, Tone Spacing = 1 MHz)

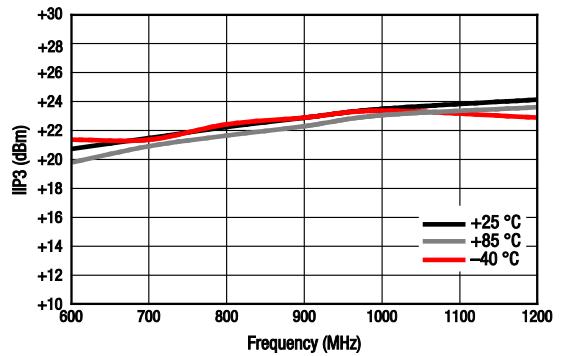

Figure 18. IIP3 vs Frequency Over Temperature ($P_{IN} = -20$ dBm, Tone Spacing = 1 MHz)

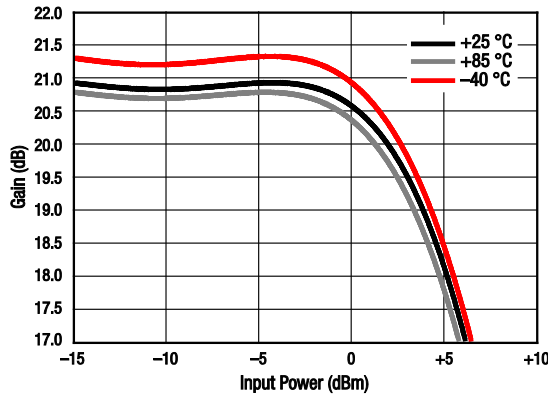

Figure 19. Gain vs Input Power Over Temperature @ 600 MHz

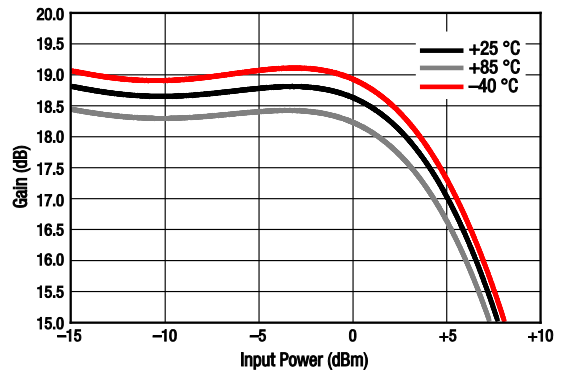

Figure 20. Gain vs Input Power Over Temperature @ 700 MHz

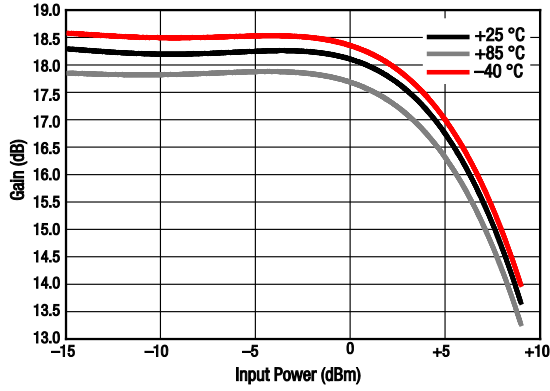

Figure 21. Gain vs Input Power Over Temperature @ 800 MHz

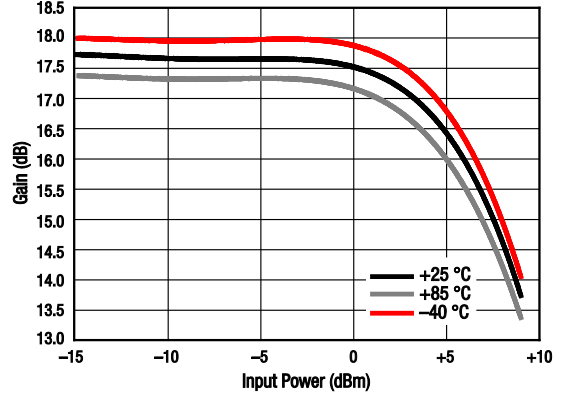

Figure 22. Gain vs Input Power Over Temperature @ 900 MHz

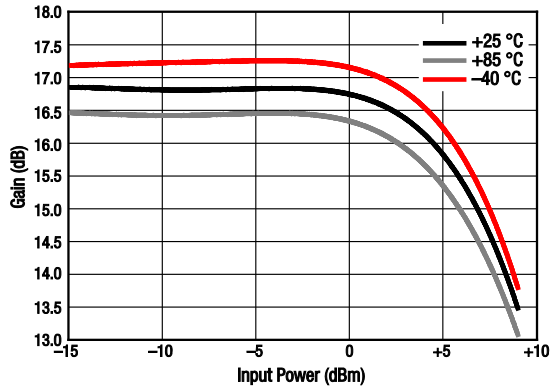

Figure 23. Gain vs Input Power Over Temperature @ 1000 MHz

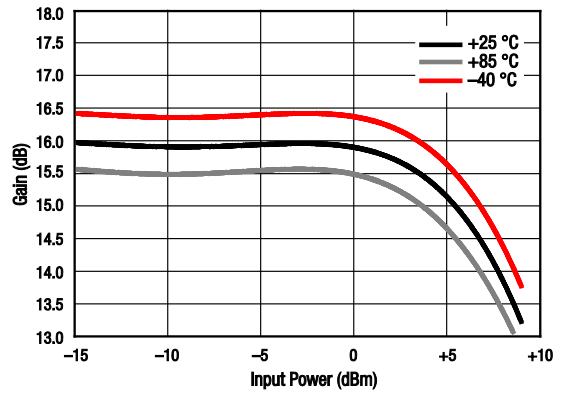

Figure 24. Gain vs Input Power Over Temperature @ 1200 MHz

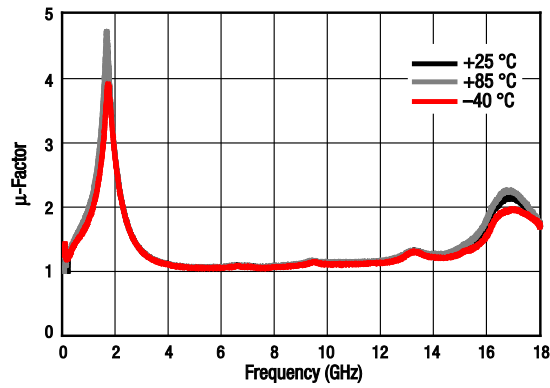

Figure 25. Stability Factor (μ) vs Frequency Over Temperature

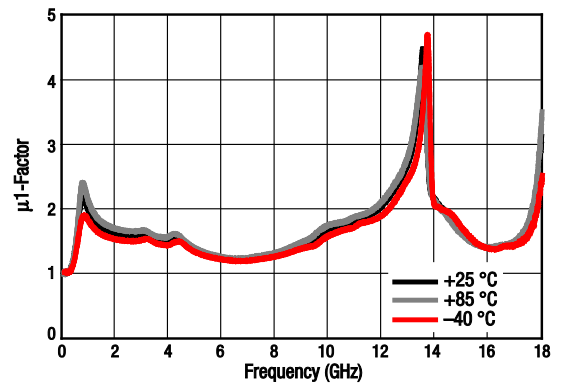

Figure 26. Stability Factor (μ_1) vs Frequency Over Temperature

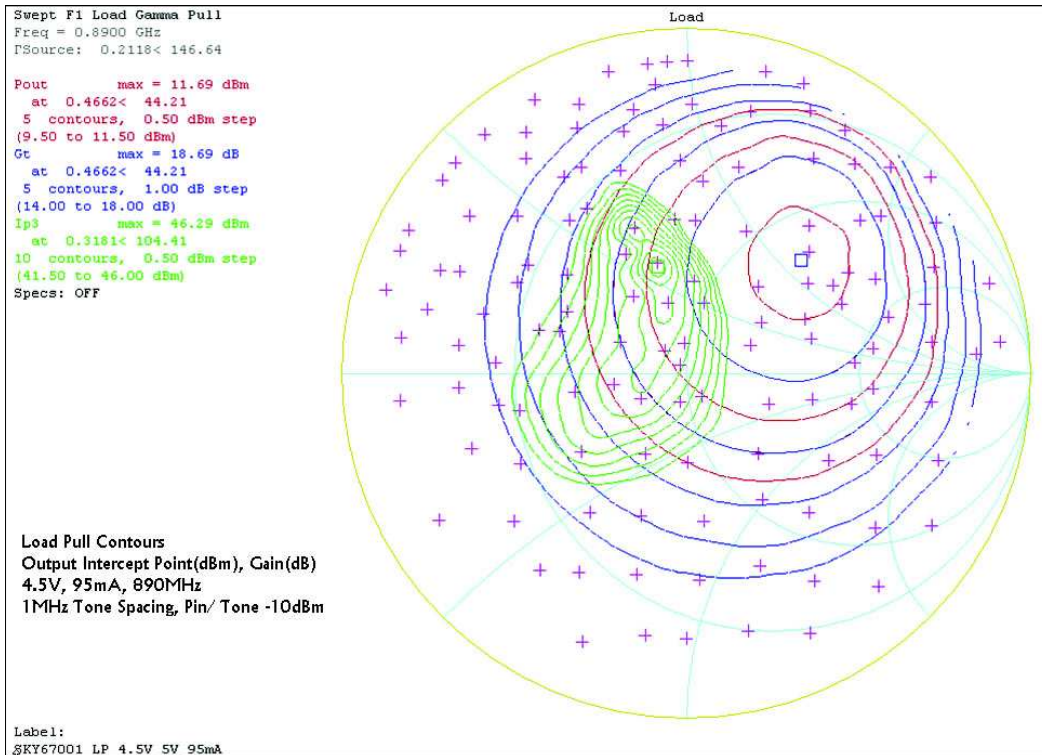

Figure 27. Load Pull, @ 4.5 V, 890 MHz, 95 mA

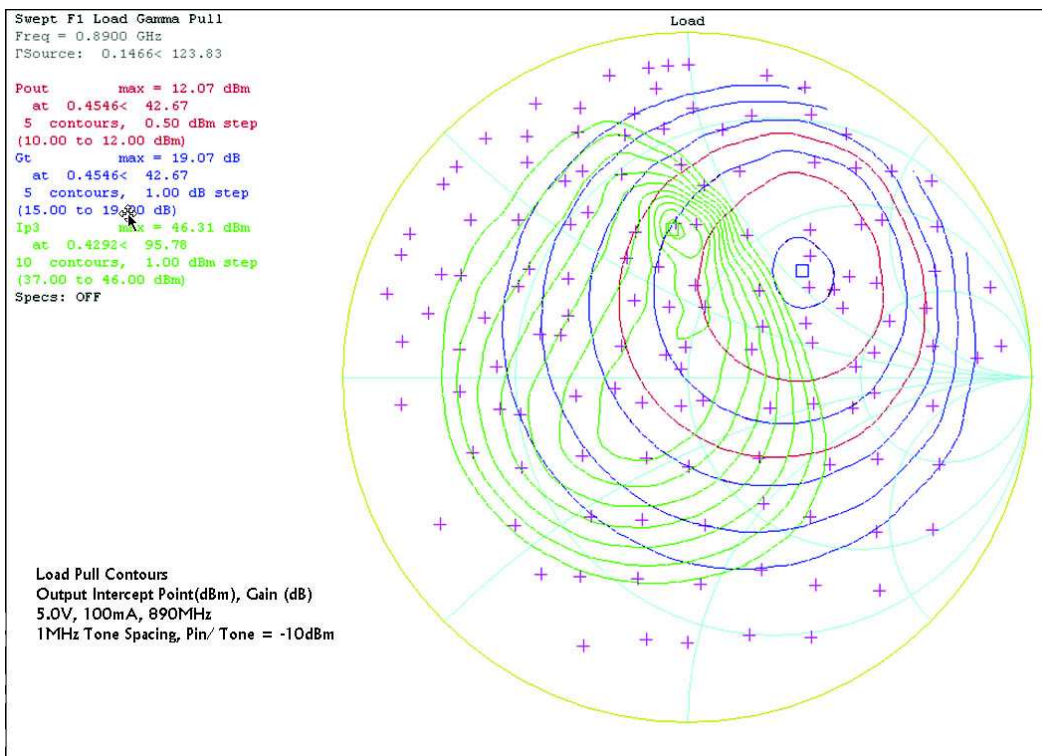

Figure 28. Load Pull, @ 5 V, 890 MHz, 100 mA

Table 4. Noise Parameters vs Frequency (1 of 2)

| Frequency (GHz) | Minimum Noise Figure (F _{MIN}) (dB) | Noise Resistance (R _N) (Ω) | Γ _{opt} | | Associated Gain (dB) | Maximum Gain (G _{MAX}) (dB) |
|----------------------|---|--|------------------|---------|-------------------------|---|
| | | | Magnitude | Phase | | |
| 4.5 V, 95 mA | | | | | | |
| 0.80 | 0.7137 | 0.0576 | 0.2837 | 113.01 | 18.7144 | 19.686 |
| 0.84 | 0.5306 | 0.0299 | 0.2542 | 128.3 | 18.1741 | 19.3168 |
| 0.89 | 0.4834 | 0.0262 | 0.2150 | 137.84 | 17.7119 | 18.8793 |
| 1.20 | 0.6824 | 0.0605 | 0.1897 | 113.45 | 15.7640 | 16.6257 |
| 1.42 | 0.8169 | 0.0756 | 0.1817 | 107.83 | 14.5806 | 15.3690 |
| 1.52 | 0.9034 | 0.0933 | 0.1672 | 111.29 | 14.0395 | 14.8646 |
| 1.76 | 0.9962 | 0.0928 | 0.1271 | 132.37 | 12.7526 | 13.7964 |
| 1.84 | 1.1784 | 0.0642 | 0.2013 | 151.97 | 12.1387 | 13.4830 |
| 1.92 | 1.1787 | 0.1031 | 0.1414 | 137.62 | 12.0903 | 13.1820 |
| 1.98 | 1.2367 | 0.1169 | 0.1183 | 146.38 | 11.7937 | 12.9662 |
| 2.00 | 1.3365 | 0.1257 | 0.1364 | 141.37 | 11.7663 | 12.8943 |
| 2.38 | 1.5751 | 0.1321 | 0.1093 | 152.37 | 10.4969 | 11.7116 |
| 2.52 | 1.6732 | 0.1548 | 0.1253 | 156.96 | 10.1028 | 11.3478 |
| 2.60 | 1.6486 | 0.1444 | 0.1085 | -159.10 | 9.5429 | 11.1602 |
| 2.70 | 1.7086 | 0.1817 | 0.1144 | 148.14 | 9.7571 | 10.9282 |
| 3.00 | 2.1104 | 0.1750 | 0.1155 | 177.44 | 8.8961 | 10.3029 |
| 3.60 | 2.5576 | 0.2635 | 0.0926 | 177.45 | 6.9115 | 8.3171 |
| 4.00 | 2.8958 | 0.2998 | 0.1510 | -165.45 | 7.4067 | 8.8578 |
| 5.00 | 3.7114 | 0.4350 | 0.2277 | -158.01 | 6.4379 | 8.2996 |
| 6.00 | 4.5269 | 0.5025 | 0.3229 | -158.65 | 5.8559 | 8.2839 |
| 7.00 | 5.3343 | 0.8091 | 0.3620 | -154.13 | 5.312 | 8.4946 |
| 5.0 V, 100 mA | | | | | | |
| 0.80 | 0.5571 | 0.0600 | 0.1286 | 129.21 | 18.8608 | 19.7254 |
| 0.84 | 0.3977 | 0.1264 | 0.1201 | 72.63 | 18.8469 | 19.3559 |
| 0.89 | 0.543 | 0.0414 | 0.1575 | 111.37 | 18.1270 | 18.9171 |
| 1.20 | 0.7077 | 0.0667 | 0.1636 | 107.57 | 15.8561 | 16.6599 |
| 1.42 | 0.8033 | 0.0777 | 0.1466 | 110.34 | 14.5550 | 15.4004 |
| 1.52 | 0.8732 | 0.0767 | 0.1751 | 130.29 | 13.8350 | 14.8953 |
| 1.76 | 1.0127 | 0.1047 | 0.1240 | 122.01 | 12.8532 | 13.8256 |
| 1.84 | 1.1337 | 0.1062 | 0.1113 | 147.04 | 12.3242 | 13.5113 |
| 1.92 | 1.1686 | 0.1132 | 0.1137 | 134.44 | 12.1251 | 13.2098 |
| 1.98 | 1.232 | 0.1021 | 0.1260 | 163.51 | 11.6427 | 12.9939 |
| 2.00 | 1.3361 | 0.2648 | 0.1212 | 74.78 | 12.1585 | 12.9206 |
| 2.38 | 1.5989 | 0.1143 | 0.1302 | 158.37 | 10.4524 | 11.7369 |

Table 4. Noise Parameters vs Frequency (2 of 2)

| Frequency (GHz) | Minimum Noise Figure (F _{MIN}) (dB) | Noise Resistance (R _N) (Ω) | Γ _{OPT} | | Associated Gain (dB) | Maximum Gain (G _{MAX}) (dB) |
|----------------------------------|---|--|------------------|---------|----------------------|---------------------------------------|
| | | | Magnitude | Phase | | |
| <i>5.0 V, 100 mA (continued)</i> | | | | | | |
| 2.52 | 1.6619 | 0.1667 | 0.1109 | 156.50 | 10.1114 | 11.3724 |
| 2.60 | 1.7366 | 0.1817 | 0.0974 | 156.70 | 9.9104 | 11.1835 |
| 2.70 | 1.6845 | 0.1032 | 0.1529 | -165.66 | 9.2704 | 10.9525 |
| 3.00 | 2.1342 | 0.1874 | 0.0978 | 171.43 | 8.9475 | 10.3251 |
| 3.60 | 2.6314 | 0.2626 | 0.0816 | 172.61 | 6.9070 | 8.3274 |
| 4.00 | 2.9366 | 0.3237 | 0.1187 | -160.48 | 7.3181 | 8.8760 |
| 5.00 | 3.7549 | 0.4659 | 0.2157 | -156.72 | 6.3847 | 8.3182 |
| 6.00 | 4.5836 | 0.4105 | 0.3645 | -149.11 | 5.9685 | 8.3084 |
| 7.00 | 5.4265 | 0.7168 | 0.3627 | -157.54 | 5.3432 | 8.5428 |

Evaluation Board Description

The SKY67001-396LF Evaluation Board is used to test the performance of the SKY67001-396LF LNA. An assembly drawing for the Evaluation Board is shown in Figure 29. The layer detail is provided in Figure 30. An Evaluation Board schematic diagram is provided in Figure 31. Table 5 provides the Bill of Materials (BOM) list for Evaluation Board components.

Package Dimensions

The PCB layout footprint for the SKY67001-396LF is provided in Figure 32. Typical case markings are shown in Figure 33. Package dimensions for the 8-pin DFN are shown in Figure 34, and tape and reel dimensions are provided in Figure 35.

Package and Handling Information

Instructions on the shipping container label regarding exposure to moisture after the container seal is broken must be followed. Otherwise, problems related to moisture absorption may occur when the part is subjected to high temperature during solder assembly.

THE SKY67001-396LF is rated to Moisture Sensitivity Level 1 (MSL1) at 260 °C. It can be used for lead or lead-free soldering. For additional information, refer to the Skyworks Application Note, *Solder Reflow Information*, document number 200164.

Care must be taken when attaching this product, whether it is done manually or in a production solder reflow environment. Production quantities of this product are shipped in a standard tape and reel format.

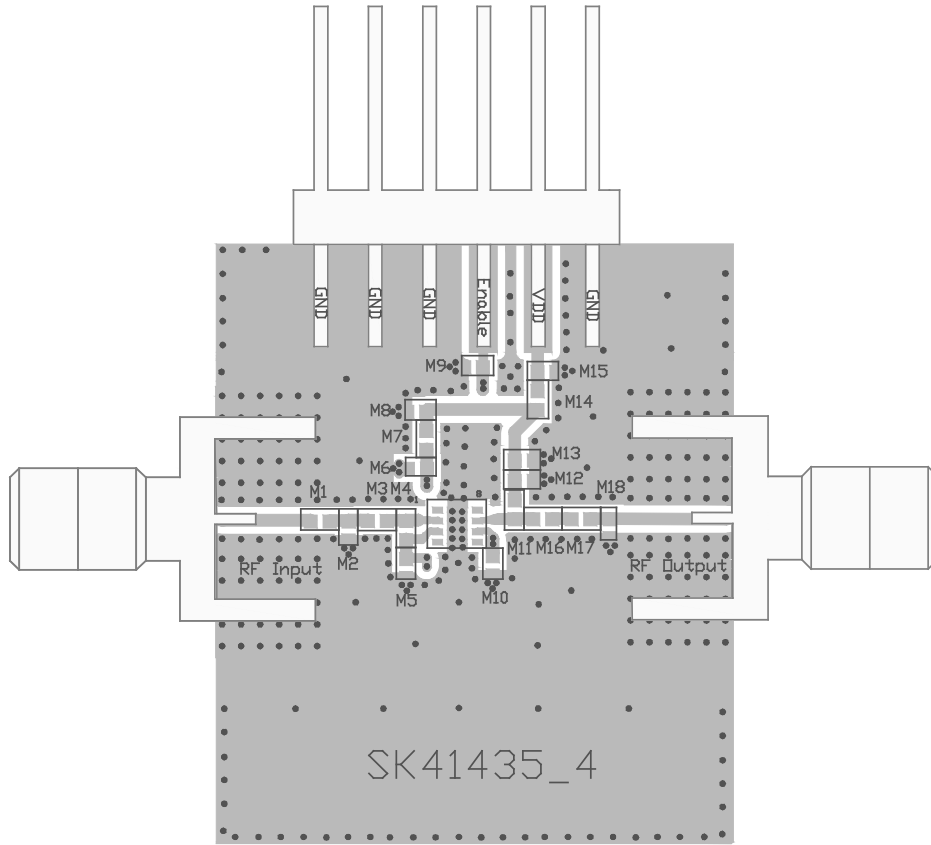

S2528

Figure 29. SKY67001-396LF Evaluation Board Assembly Diagram

| Cross Section | Name | Thickness (mm) | Material |
|---------------|----------|----------------|----------------------|
| | MSK-NS | | |
| | TRA-NS | 0.3556 | Cu foil |
| | Laminate | 0.254 ± 0.152 | Rogers 4350B |
| | TRA-2 | 0.0178 | Cu foil |
| | Laminate | 0.889 nom. | FR4 Prepreg (Note 1) |
| | TRA-3 | 0.0178 | Cu foil |
| | Laminate | 0.254 ± 0.152 | FR4 Core |
| | TRA-FS | 0.0178 | Cu foil |
| | MSK-PS | | |

Note 1: Adjust this thickness to meet total thickness goal.

General Notes:

Material: Rogers R04350, $\epsilon_r = 3.66$
 Layer 1 thickness: 0.254 mm
 Overall board thickness: 1.575 mm
 50 Ω transmission line width: 0.522 mm
 Coplanar ground spacing: 0.394 mm
 Via diameter: 0.254 mm

S2630

Figure 30. Layer Detail Physical Characteristics

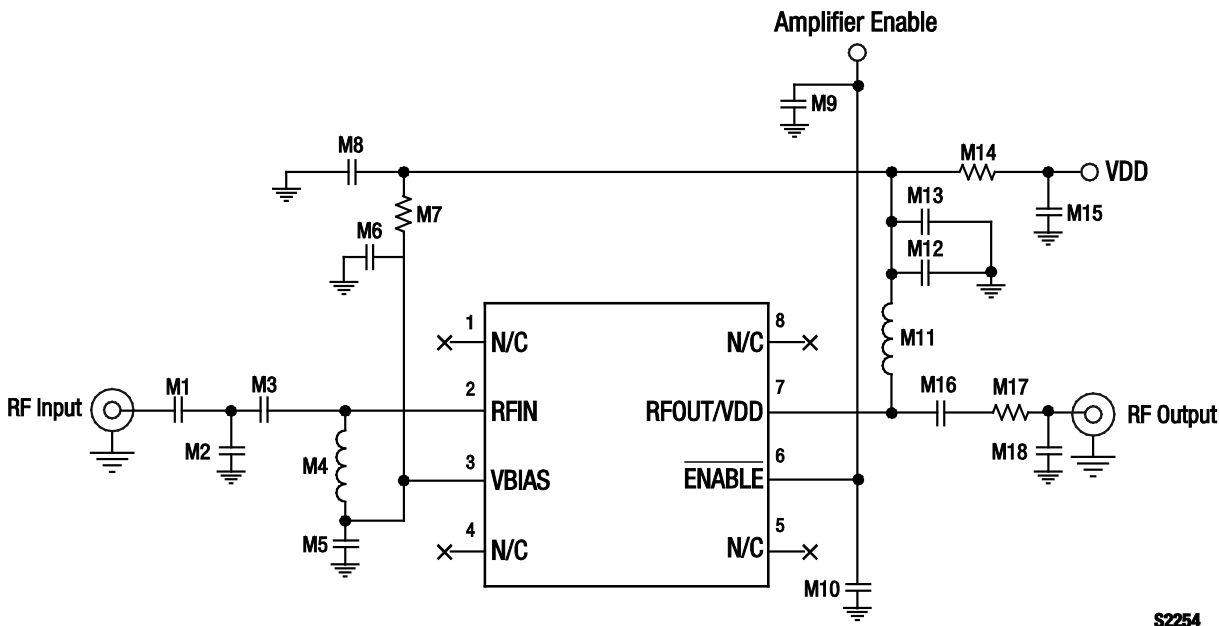

Figure 31. SKY67001-396LF Evaluation Board Schematic

Table 5. SKY67001-396LF Evaluation Board Bill of Materials

| Component | Type | Value | Size | Manufacturer |
|-----------|-----------|---------|------|--------------|
| M1 | Resistor | 0 Ω | 0402 | Panasonic |
| M2 | DNI | | | |
| M3 | Capacitor | 6 pF | 0402 | Murata GJM |
| M4 | Inductor | 12 nH | 0402 | Coilcraft HP |
| M5 | Capacitor | 68 pF | 0402 | Murata GRM |
| M6 | DNI | | | |
| M7 | Resistor | 3.6 kΩ | 0402 | Panasonic |
| M8 | Capacitor | 0.1 μF | 0402 | Murata GRM |
| M9 | DNI | | | |
| M10 | Capacitor | 1000 pF | 0402 | Murata GRM |
| M11 | Inductor | 27 nH | 0402 | Murata LQG |
| M12 | Capacitor | 10 pF | 0402 | Murata GRM |
| M13 | Capacitor | 1000 pF | 0402 | Murata GRM |
| M14 | Resistor | 0 Ω | 0402 | Panasonic |
| M15 | DNI | | | |
| M16 | Inductor | 4.3 nH | 0402 | Murata LQG |
| M17 | Capacitor | 82 pF | 0402 | Murata GRM |
| M18 | DNI | | | |

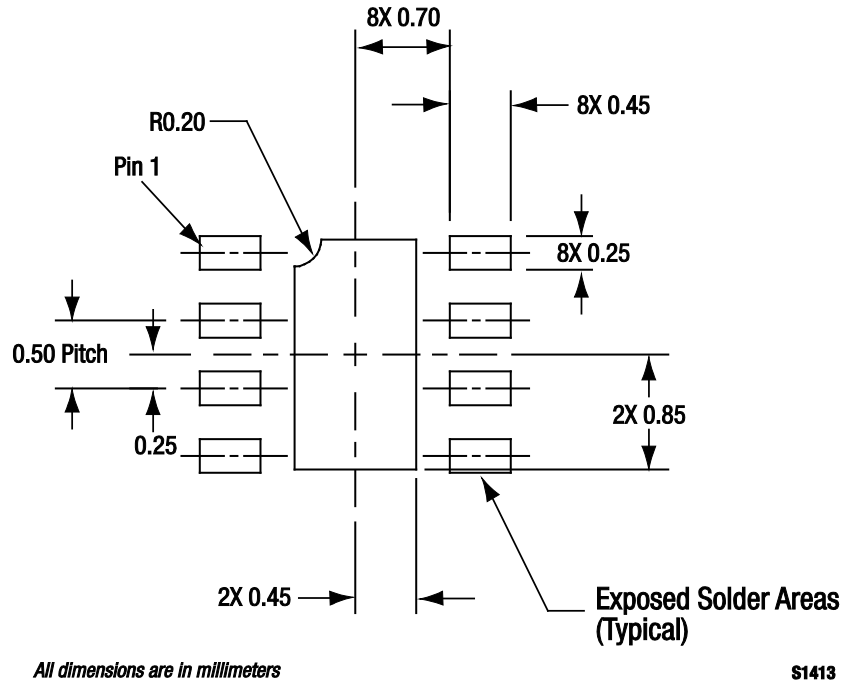

Figure 32. SKY67001-396LF PCB Layout Footprint (Top View)

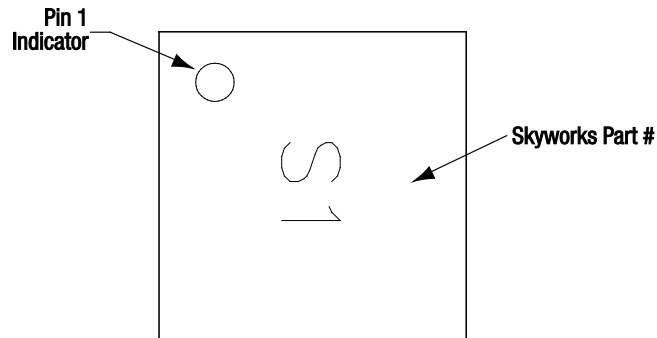
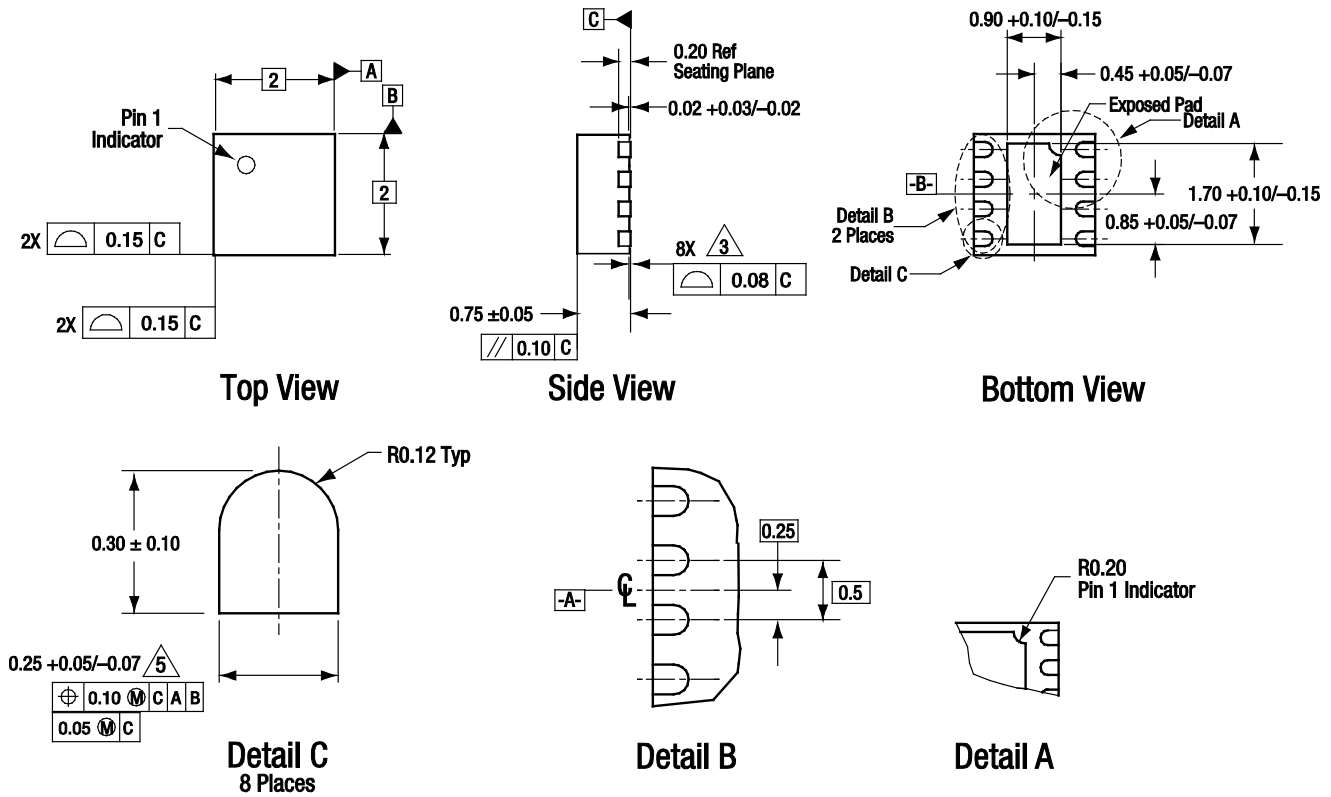

Figure 33. Typical Case Markings (Top View)



All measurements are in millimeters.
 Dimensioning and tolerancing according to ASME Y14.5M-1994.
 Coplanarity applies to the exposed heat sink slug as well as the terminals..
 Plating requirement per source control drawing (SCD) 2504.
 Dimension applies to metallized terminal and is measured between 0.15 mm and 0.30 mm from terminal tip.

S1945

Figure 34. SKY67001-396LF 8-Pin DFN Package Dimensions

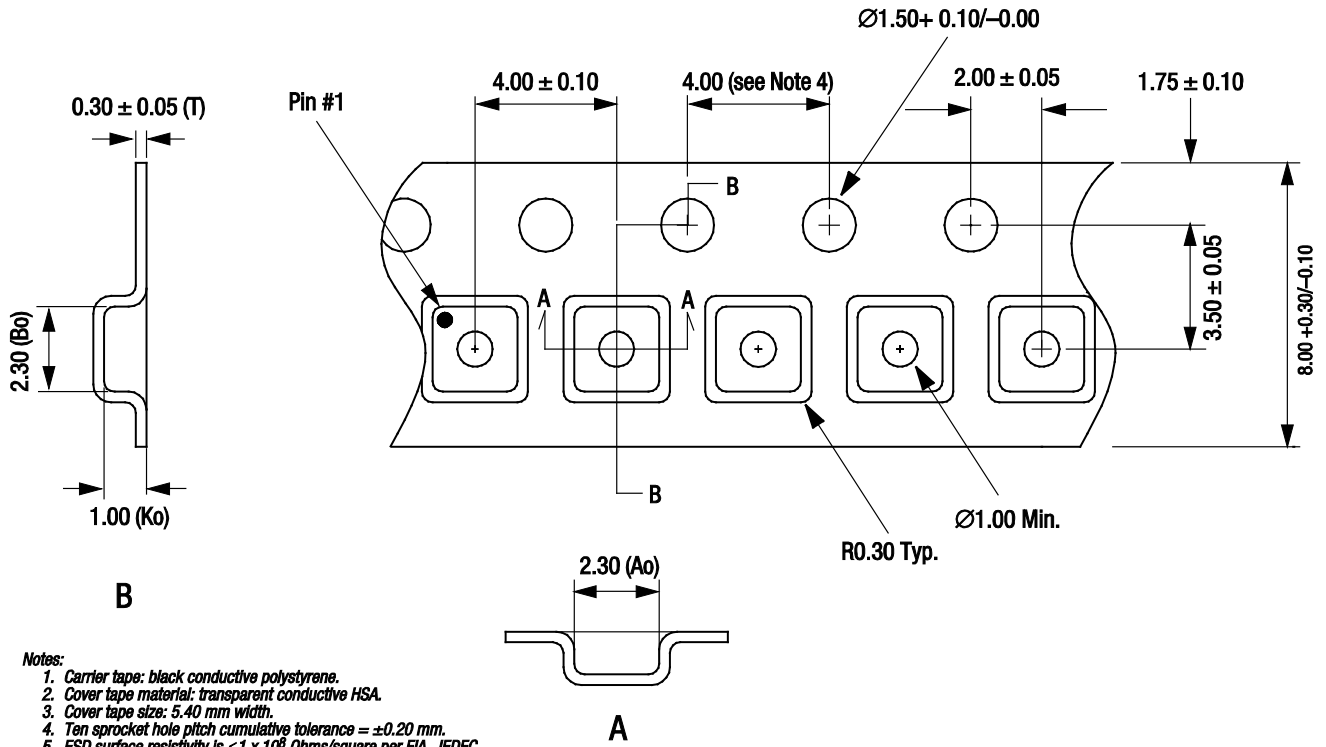

Notes:

1. Carrier tape: black conductive polystyrene.
2. Cover tape material: transparent conductive HSA.
3. Cover tape size: 5.40 mm width.
4. Ten sprocket hole pitch cumulative tolerance = ± 0.20 mm.
5. ESD surface resistivity is $\leq 1 \times 10^8$ Ohms/square per EIA, JEDEC tape and reel specification.
6. A_o and B_o measurement point to be 0.30 mm from bottom pocket.
7. All measurements are in millimeters.

S1601

Figure 35. SKY67001-396LF Tape and Reel Dimensions

Ordering Information

| Model Name | Manufacturing Part Number | Evaluation Board Part Number |
|--------------------|---------------------------|------------------------------|
| SKY67001-396LF LNA | SKY67001-396LF | SKY67001-396LF-EVB |

Copyright © 2011 Skyworks Solutions, Inc. All Rights Reserved.

Information in this document is provided in connection with Skyworks Solutions, Inc. ("Skyworks") products or services. These materials, including the information contained herein, are provided by Skyworks as a service to its customers and may be used for informational purposes only by the customer. Skyworks assumes no responsibility for errors or omissions in these materials or the information contained herein. Skyworks may change its documentation, products, services, specifications or product descriptions at any time, without notice. Skyworks makes no commitment to update the materials or information and shall have no responsibility whatsoever for conflicts, incompatibilities, or other difficulties arising from any future changes.

No license, whether express, implied, by estoppel or otherwise, is granted to any intellectual property rights by this document. Skyworks assumes no liability for any materials, products or information provided hereunder, including the sale, distribution, reproduction or use of Skyworks products, information or materials, except as may be provided in Skyworks Terms and Conditions of Sale.

THE MATERIALS, PRODUCTS AND INFORMATION ARE PROVIDED "AS IS" WITHOUT WARRANTY OF ANY KIND, WHETHER EXPRESS, IMPLIED, STATUTORY, OR OTHERWISE, INCLUDING FITNESS FOR A PARTICULAR PURPOSE OR USE, MERCHANTABILITY, PERFORMANCE, QUALITY OR NON-INFRINGEMENT OF ANY INTELLECTUAL PROPERTY RIGHT; ALL SUCH WARRANTIES ARE HEREBY EXPRESSLY DISCLAIMED. SKYWORKS DOES NOT WARRANT THE ACCURACY OR COMPLETENESS OF THE INFORMATION, TEXT, GRAPHICS OR OTHER ITEMS CONTAINED WITHIN THESE MATERIALS. SKYWORKS SHALL NOT BE LIABLE FOR ANY DAMAGES, INCLUDING BUT NOT LIMITED TO ANY SPECIAL, INDIRECT, INCIDENTAL, STATUTORY, OR CONSEQUENTIAL DAMAGES, INCLUDING WITHOUT LIMITATION, LOST REVENUES OR LOST PROFITS THAT MAY RESULT FROM THE USE OF THE MATERIALS OR INFORMATION, WHETHER OR NOT THE RECIPIENT OF MATERIALS HAS BEEN ADVISED OF THE POSSIBILITY OF SUCH DAMAGE.

Skyworks products are not intended for use in medical, lifesaving or life-sustaining applications, or other equipment in which the failure of the Skyworks products could lead to personal injury, death, physical or environmental damage. Skyworks customers using or selling Skyworks products for use in such applications do so at their own risk and agree to fully indemnify Skyworks for any damages resulting from such improper use or sale.

Customers are responsible for their products and applications using Skyworks products, which may deviate from published specifications as a result of design defects, errors, or operation of products outside of published parameters or design specifications. Customers should include design and operating safeguards to minimize these and other risks. Skyworks assumes no liability for applications assistance, customer product design, or damage to any equipment resulting from the use of Skyworks products outside of stated published specifications or parameters.

Skyworks, the Skyworks symbol, and "Breakthrough Simplicity" are trademarks or registered trademarks of Skyworks Solutions, Inc., in the United States and other countries. Third-party brands and names are for identification purposes only, and are the property of their respective owners. Additional information, including relevant terms and conditions, posted at www.skyworksinc.com, are incorporated by reference.