



### Features

- Frequency Range 50MHz to 4000MHz
- 6-Bits, 31.5dB Range, 0.5dB Step
- High Linearity, IP3 >48dBm
- 3V and 5V Logic Compatible
- Serial-to-Parallel Controller
- Serial Programming Interface
- Power-up Programming Modes
- On-Chip ESD Protection Class 1C HBM
- Single Supply, 3V to 5V Operation
- Footprint Compatible with Most 24-Pin, 4mm x 4mm, QFNs

### Applications

- Transceiver RF and IF Applications
- Cellular, PCS, GSM, UMTS, LTE, WiMax/WiFi
- Wireless Data, Satellite Terminals
- Test Equipment

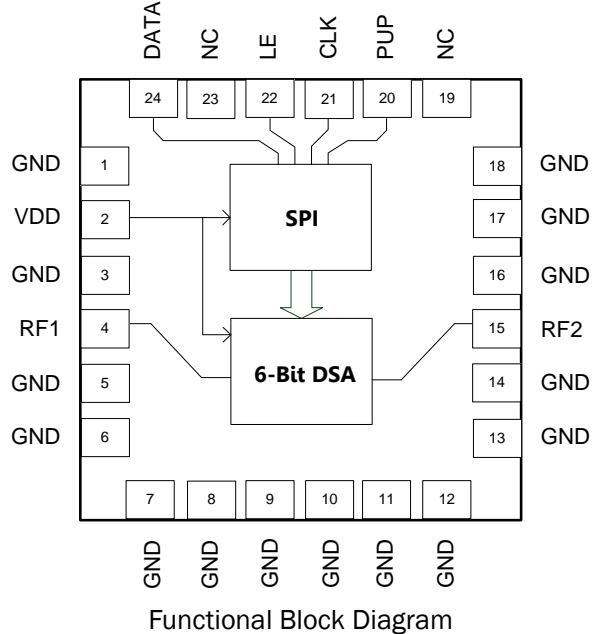

### Product Description

RFMD's RFSA2644 is a 6-bit digital step attenuator (DSA) that features high linearity over the entire 31.5dB gain control range with excellent step accuracy in 0.5dB steps. The RFSA2644 is programmed via a serial mode control interface that is both 3V and 5V compatible. The RFSA2644 also offers a rugged Class 1C HBM ESD rating via on-chip ESD circuitry. The MCM package is footprint compatible with most 24-pin, 4mm x 4mm, QFN packages.

### Ordering Information

RFSA2644SR	7" Sample reel with 100 pieces
RFSA2644SQ	25-Piece sample bag
RFSA2644TR7	7" Reel with 750 pieces
RFSA2644TR13	13" Reel with 2500 pieces
RFSA2644PCK-410	50MHz to 4000MHz PCBA with 5-piece sample bag

### Optimum Technology Matching® Applied

- |                                      |                                      |                                                |                                    |
|--------------------------------------|--------------------------------------|------------------------------------------------|------------------------------------|
| <input type="checkbox"/> GaAs HBT    | <input type="checkbox"/> SiGe BiCMOS | <input checked="" type="checkbox"/> GaAs pHEMT | <input type="checkbox"/> GaN HEMT  |
| <input type="checkbox"/> GaAs MESFET | <input type="checkbox"/> Si BiCMOS   | <input checked="" type="checkbox"/> Si CMOS    | <input type="checkbox"/> BiFET HBT |
| <input type="checkbox"/> InGaP HBT   | <input type="checkbox"/> SiGe HBT    | <input type="checkbox"/> Si BJT                |                                    |

RF MICRO DEVICES®, RFMD®, Optimum Technology Matching®, Enabling Wireless Connectivity™, PowerStar®, POLARIS™ TOTAL RADIO™ and UltimateBlue™ are trademarks of RFMD, LLC. BLUETOOTH is a trademark owned by Bluetooth SIG, Inc., U.S.A. and licensed for use by RFMD. All other trade names, trademarks and registered trademarks are the property of their respective owners. ©2012, RF Micro Devices, Inc.

## Absolute Maximum Ratings

Parameter	Rating	Unit
Supply Voltage	+5.5	V
DC Supply Current	15	mA
Power Dissipation	83	mW
Max RF Input Power	28.3	dBm
Operating Temperature (T <sub>CASE</sub> )	-40 to +85	°C
Storage Temperature	-40 to +150	°C
Junction Temperature	150	°C
ESD Rating (HBM)	Class 1C	V
Moisture Sensitivity Level	MSL3	



**Caution!** ESD sensitive device.

Exceeding any one or a combination of the Absolute Maximum Rating conditions may cause permanent damage to the device. Extended application of Absolute Maximum Rating conditions to the device may reduce device reliability. Specified typical performance or functional operation of the device under Absolute Maximum Rating conditions is not implied.

The information in this publication is believed to be accurate and reliable. However, no responsibility is assumed by RF Micro Devices, Inc. ("RFMD") for its use, nor for any infringement of patents, or other rights of third parties, resulting from its use. No license is granted by implication or otherwise under any patent or patent rights of RFMD. RFMD reserves the right to change component circuitry, recommended application circuitry and specifications at any time without prior notice.



RFMD Green: RoHS compliant per EU Directive 2002/95/EC, halogen free per IEC 61249-2-21, < 1000ppm each of antimony trioxide in polymeric materials and red phosphorus as a flame retardant, and <2% antimony in solder.

Parameter	Specification			Unit	Condition
	Min.	Typ.	Max.		
Frequency Range	50		4000	MHz	5V, 25 °C unless otherwise stated
Insertion Loss		0.6		dB	50MHz, 0dB attenuation
		0.7		dB	500MHz, 0dB attenuation
		0.8		dB	880MHz, 0dB attenuation
		1.2		dB	2140MHz, 0dB attenuation
		1.4			2700MHz, 0dB attenuation
		1.8		dB	4000MHz, 0dB attenuation
Gain Control Range		31.5		dB	0.5dB step size
Step Accuracy	±(0.1+5% attenuation range)			dB	
Input IP3	48	55		dBm	
Input P0.5dB	20	20.2		dBm	Under 100MHz, all states
	28	30		dBm	150MHz to 1000MHz, all states
Input Return Loss	13	29		dBm	Under 2700MHz
	10	18		dBm	2700MHz to 4000MHz
Output Return Loss	13	27		dBm	Under 2700MHz
	11.5	22		dBm	2700MHz to 4000MHz
Control Interface	6-Bit, Serial				Serial interface
Settling Time		200		nS	t <sub>RISE</sub> , t <sub>FALL</sub> (10%/90% RF)
Switching Speed		200		nS	t <sub>ON</sub> , t <sub>OFF</sub> (50% CTL to 10%/90% RF)
Supply Voltage (V <sub>DD</sub> )	4.75	5.0	5.25	V	
Supply Current		5.2		mA	
Control Voltage (V <sub>CTL</sub> )	Low, V <sub>CTL</sub> = 0 to 0.8V			V	
	High, V <sub>CTL</sub> = 2.0 to V <sub>DD</sub>			V	

**Notes:**

- V<sub>DD</sub> = 5V, V<sub>CTL</sub> = 5V, T = 25 °C
- IIP3 measured with P<sub>IN</sub> = 17dBm/tone, 1MHz spacing

Parameter	Specification			Unit	Condition
	Min.	Typ.	Max.		
Frequency Range	50		4000	MHz	3V, 25 °C unless otherwise stated
Insertion Loss		0.7		dB	50MHz, 0dB attenuation
		0.7		dB	500MHz, 0dB attenuation
		1.0		dB	880MHz, 0dB attenuation
		1.2		dB	2140MHz, 0dB attenuation
		1.5			2700MHz, 0dB attenuation
		1.8		dB	4000MHz, 0dB attenuation
Gain Control Range		31.5		dB	0.5dB step size
Step Accuracy	±(0.1 + 5% attenuation range)			dB	
Input IP3		48		dBm	
Input P0.5dB		20		dBm	Under 100MHz, all states
		27		dBm	1000MHz, all states
Input Return Loss		13		dBm	Under 2700MHz
		10		dBm	2700MHz to 4000MHz
Output Return Loss		13		dBm	Under 2700MHz
		11		dBm	2700MHz to 4000MHz
Control Interface		6-Bit, Serial			Serial interface
Settling Time		200		nS	t <sub>RISE</sub> , t <sub>FALL</sub> (10%/90% RF)
Switching Speed		200		nS	t <sub>ON</sub> , t <sub>OFF</sub> (50% CTL to 10%/90% RF)
Supply Voltage (V <sub>DD</sub> )	2.8	3.0	3.3	V	
Supply Current		5.0		mA	
Control Voltage (V <sub>CTL</sub> )	Low, V <sub>CTL</sub> = 0 to 0.8V			V	
	High, V <sub>CTL</sub> = 2.0 to V <sub>DD</sub>			V	

**Notes:**

- V<sub>DD</sub> = 3V, V<sub>CTL</sub> = 3V, T = 25 °C
- IIP3 measured with P<sub>IN</sub> = 17dBm/tone, 1MHz spacing

## Typical Performance at 5V V<sub>DD</sub> - Broadband Application Circuit

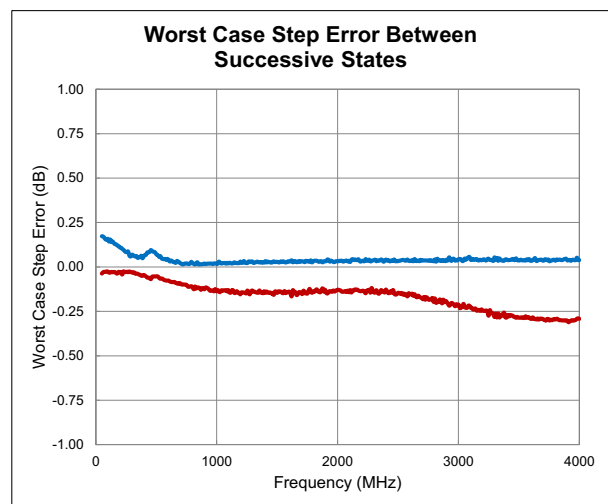
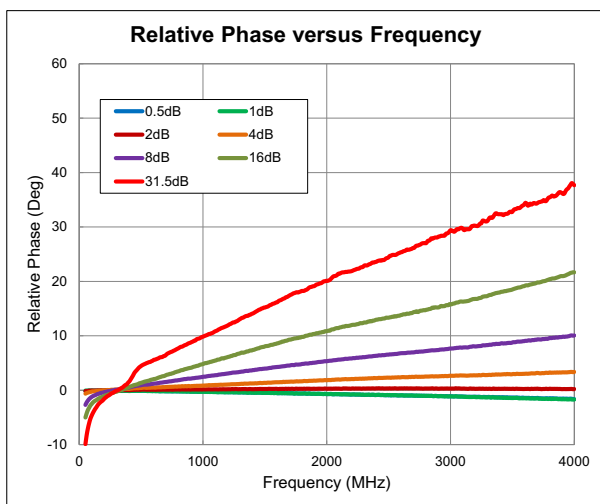
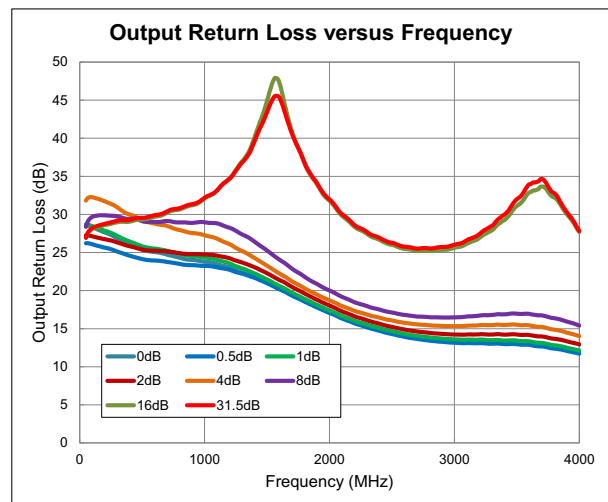
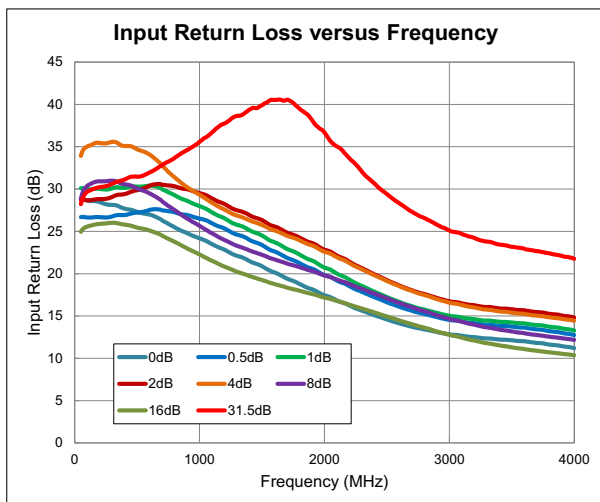
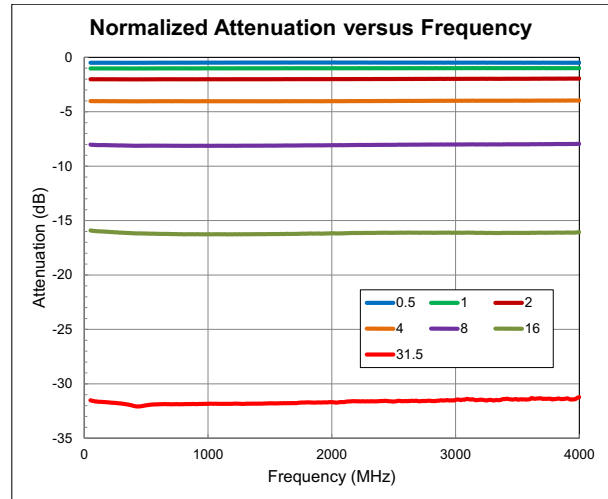
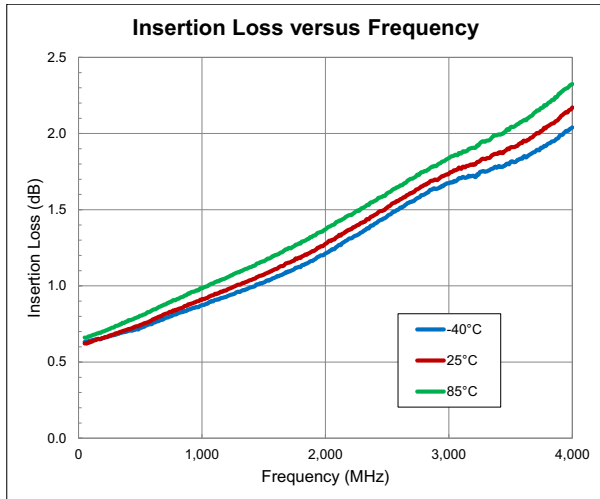

Typical Performance at 5V V<sub>DD</sub> - Broadband Application Circuit

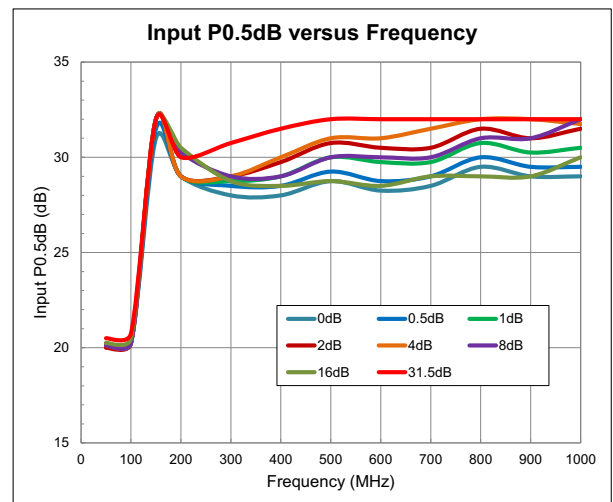
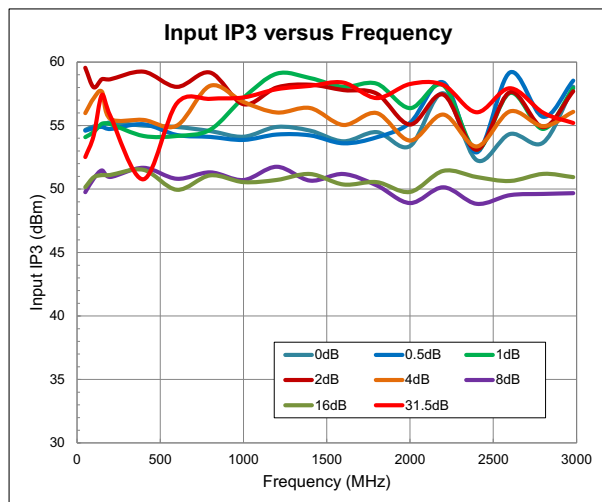
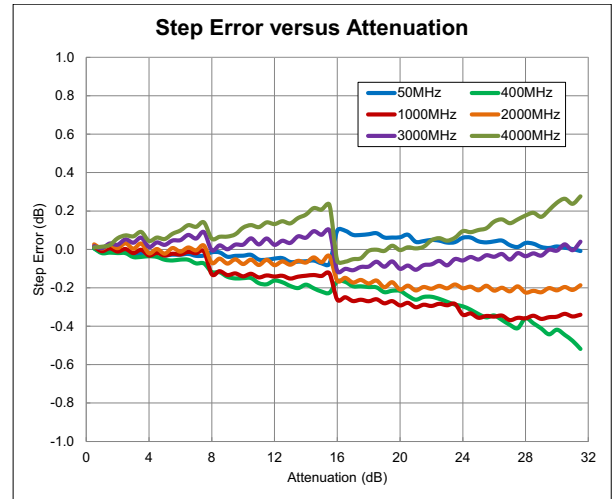
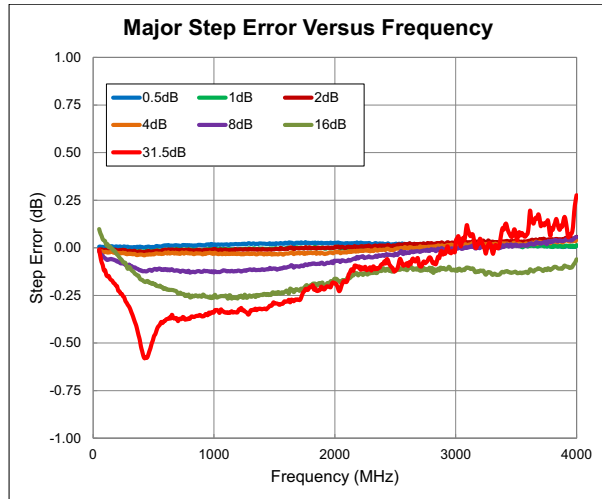

## Serial Port Interface

SPI Timing Diagram

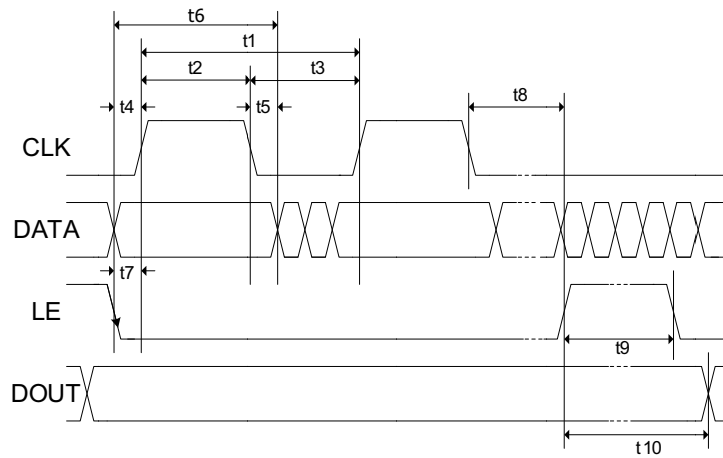

Programming Example - 6-Bit

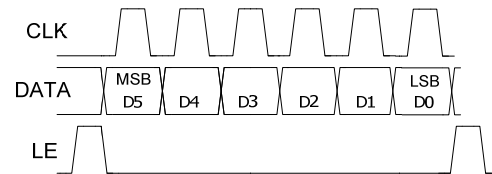

## Truth Table

Control Bit						Relative Gain Setting
C16	C8	C4	C2	C1	C0.5	
1	1	1	1	1	1	Max gain
1	1	1	1	1	0	-0.5dB
1	1	1	1	0	1	-1dB
1	1	1	0	1	1	-2dB
1	1	0	1	1	1	-4dB
1	0	1	1	1	1	-8dB
0	1	1	1	1	1	-16dB
0	0	0	0	0	0	-31.5dB

## SPI Timing Diagram Specifications

Parameter	Limit	Unit	Comment
t1	25	MHz max	CLK Frequency
t2	20	ns min	CLK High
t3	20	ns min	CLK Low
t4	5	ns min	DATA to CLK Setup Time
t5	5	ns min	DATA to CLK Hold Time
t6	30	ns min	Data Valid
t7	5	ns min	LE to CLK Setup Time
t8	5	ns min	CLK to LE Setup Time
t9	10	ns min	LE Pulse Width
t10	20	ns max	Output Set

Logic Voltage Levels	
State	Logic
Low	0V to 0.8V
High	2.0V to 5.0V

Power-up Programming Truth Table	
PUP	Attenuator Setting
Low	Attenuation at max, 31.5dB
High	Attenuation at min, 0dB

**Evaluation Board Schematic**

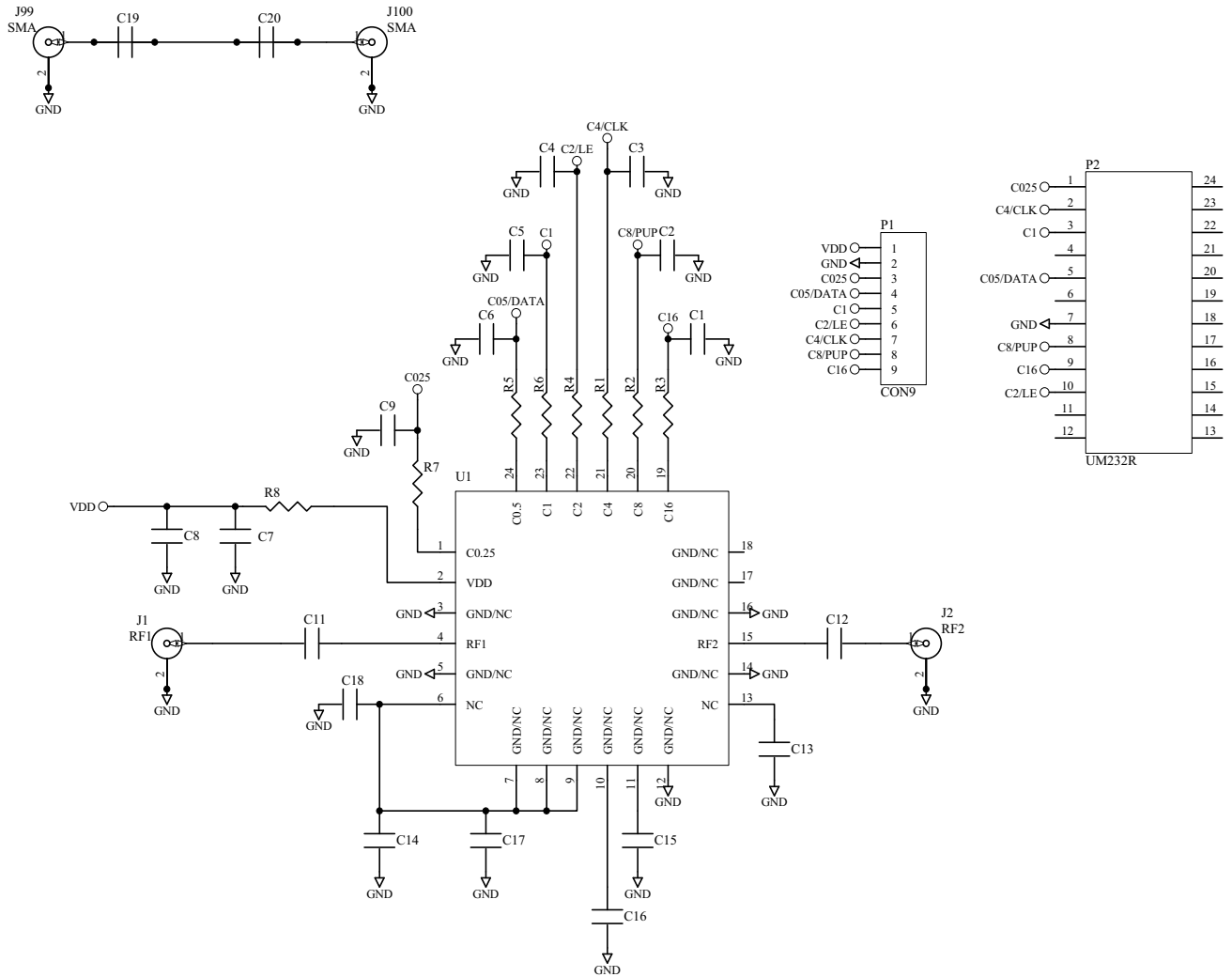

## Evaluation Board Bill of Materials (BOM)

Description	Reference Designator	Manufacturer	Manufacturer's P/N
RFSA2714410(A)		Dynamic Details (DDI) Toronto	SA2714410(A)
50MHz to 4000MHz Serial 6-Bit DSA 0.5dB Step	U1	RFMD	RFSA2644SB
CAP, 1000pF, 10%, 50V, X7R, 0402	C7	Taiyo Yuden (USA), Inc.	RM UMK105BJ102KV-F
CAP, 470pF, 10%, 50V, X7R, 0402	C11-C12	Murata Electronics	GRM155R71H471KA01E
CONN, SMA, END LNCH, UNIV, HYB MNT, FLT	J1-J2, J99-J100	Molex	SD-73251-4000
CONN, HDR, ST, PLRZD, 9-PIN	P1	ITW Pancon	MPSS100-9-C
CONN, SKT, 24-PIN DIP, .600", T/H	P2	Aries Electronics Inc.	24-6518-10
MOD, USB TO SERIAL UART, SSOP-28	M1 (See Note Below)	Future Technology Devices Int'l	UM232R
RES, 0Ω, 0402	R1-R2, R4-R5, R8	Kamaya, Inc	RMC1/16SJPTH
DNP	C1-C6, C8-C9, C13, C18-C20	NA	NA
DNP	R3, R6-R7	NA	NA

Note: M1 is to be mounted into P2 with respect to the Pin 1 alignment of M1 and P2



### Pin Names and Descriptions

Pin	Name	Description
<b>1</b>	<b>GND</b>	Connect to Low Inductance Path to Ground.
<b>2</b>	<b>VDD</b>	Power Supply.
<b>3</b>	<b>GND</b>	Connect to Low Inductance Path to Ground.
<b>4</b>	<b>RF1</b>	RF Port; External DC Block Required.
<b>5</b>	<b>GND</b>	Connect to Low Inductance Path to Ground.
<b>6</b>	<b>GND</b>	Connect to Low Inductance Path to Ground.
<b>7</b>	<b>GND</b>	Connect to Low Inductance Path to Ground.
<b>8</b>	<b>GND</b>	Connect to Low Inductance Path to Ground.
<b>9</b>	<b>GND</b>	Connect to Low Inductance Path to Ground.
<b>10</b>	<b>GND</b>	Connect to Low Inductance Path to Ground.
<b>11</b>	<b>GND</b>	Connect to Low Inductance Path to Ground.
<b>12</b>	<b>GND</b>	Connect to Low Inductance Path to Ground.
<b>13</b>	<b>GND</b>	Connect to Low Inductance Path to Ground.
<b>14</b>	<b>GND</b>	Connect to Low Inductance Path to Ground.
<b>15</b>	<b>RF2</b>	RF Port; External DC Block Required.
<b>16</b>	<b>GND</b>	Connect to Low Inductance Path to Ground.
<b>17</b>	<b>GND</b>	Connect to Low Inductance Path to Ground.
<b>18</b>	<b>GND</b>	Connect to Low Inductance Path to Ground.
<b>19</b>	<b>NC</b>	No Internal Connection; EVB Can Be Ground or No Connect.
<b>20</b>	<b>PUP</b>	Power-up Programming Pin. Low = Max Attenuation (31.5dB) at Power-up. High = Min Attenuation (0dB) at Power-up.
<b>21</b>	<b>CLK</b>	Serial Clock.
<b>22</b>	<b>LE</b>	Latch Enable.
<b>23</b>	<b>NC</b>	No Internal Connection; EVB Can Be Ground or No Connect.
<b>24</b>	<b>DATA</b>	Serial Data.
<b>EPAD</b>	<b>GND</b>	DC and RF Ground; Must be Soldered to EVB Ground Plane Over a Bed of Vias for Thermal and RF Performance.

Evaluation Board Assembly Drawing

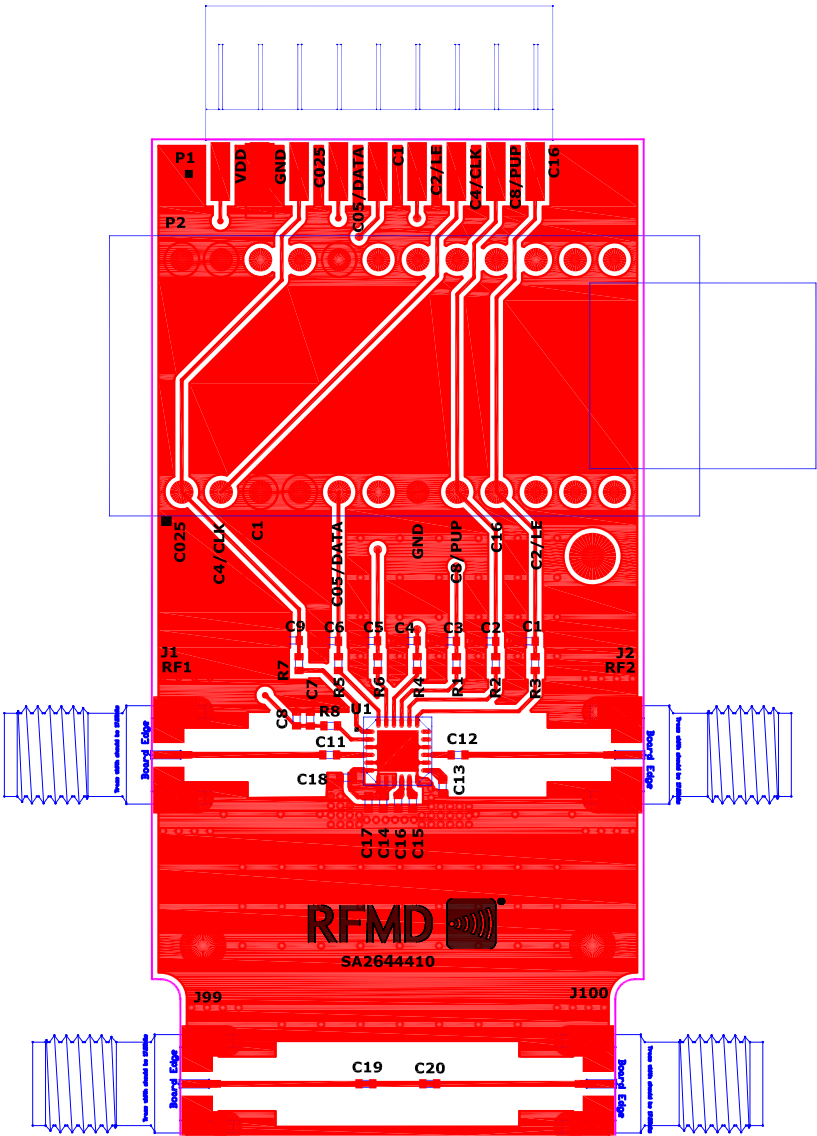

Package Outline Drawing

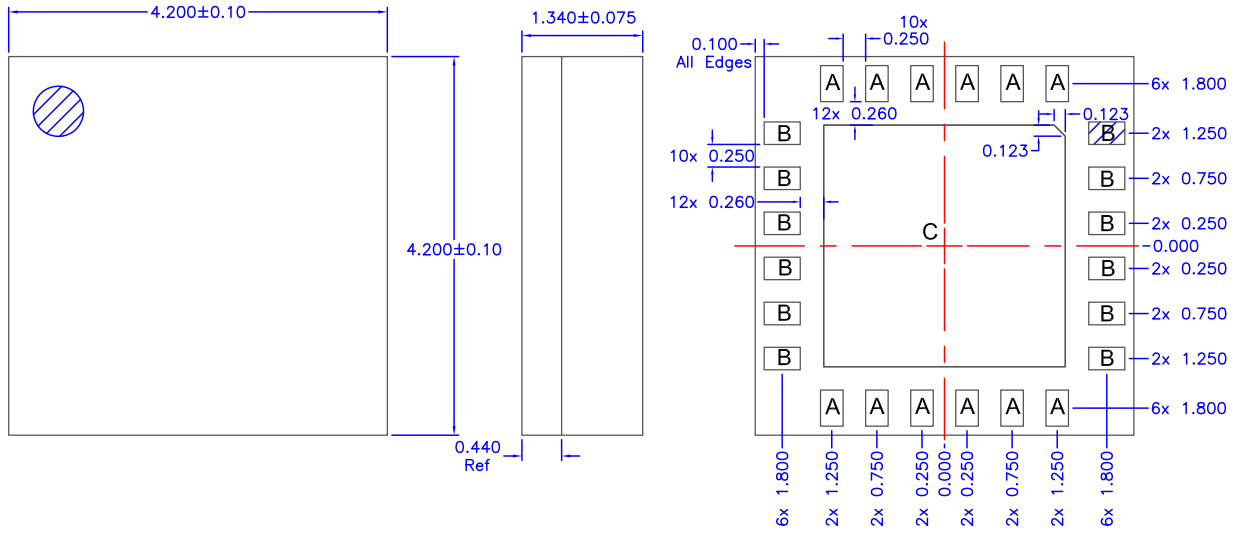

Notes:  
 1. Shaded area represents Pin 1 location.

A = 0.250 x 0.400 mm  
 B = 0.400 x 0.250 mm  
 C = 2.680 x 2.680 mm

### IO Pattern Label

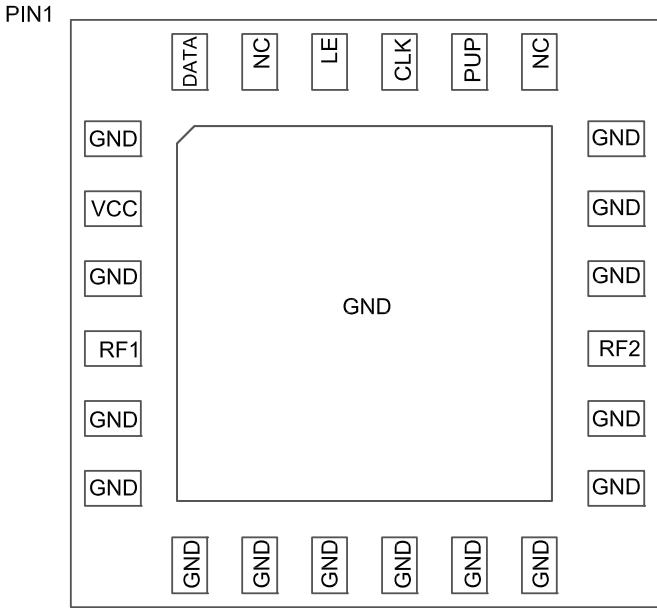

### Branding Diagram

Dimensions in millimeters

Refer to drawing posted at [www.rfmd.com](http://www.rfmd.com) for tolerances

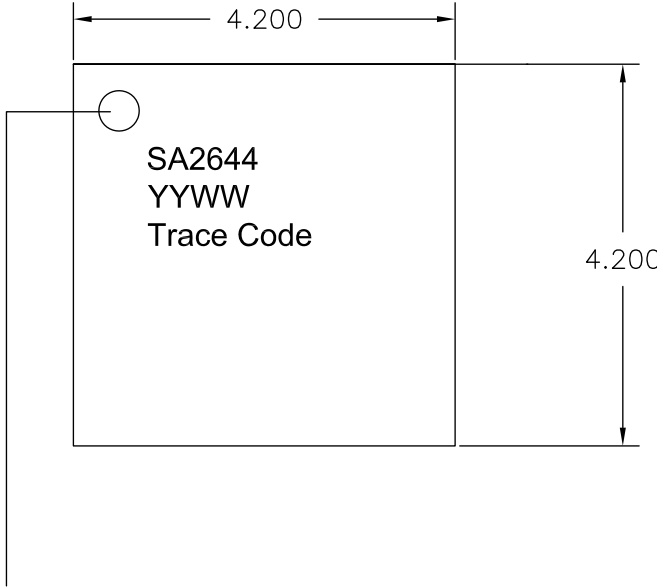

Pin 1 Indicator  
YY = Year  
WW = Week